

PARTNER RESOURCE GUIDE



FROM OUR HANDS TO YOURS SINCE 1872



SUPERIOR HEAVY-DUTY TOOLS
STRUCTRON

SEYMOUR

KENYON

Toolite

MIDWEST RAKE

LINK HANDLES

FAMILY OWNED AMERICAN TOOL COMPANY SINCE 1872

Dear Seymour Midwest Partners,

If you're looking for a commodity tool company, we're sorry you've come to the wrong place. However, if you're looking for a **Partner** who has never stopped engineering and manufacturing long handled and **task specific tools**, well, you've come to the right place.

Our **commitment to excellence** has not wavered since 1872 when the Company we're proud to lead today was founded. In an era of endless value engineering, product rationalization & increasingly anonymous companies, we're delighted to lead **a team of passionate employees that are dedicated to being toolmakers.**

At Seymour Midwest we start every day with two very simple goals, both of which start with you our Customers and Partners:

- **Delight the Customer**
- **Outperform the Competition**

We trust you'll find that our **Partner Resource Guide** meets both of our goals and ultimately makes it **easier for you to buy, your customers to sell, and the end-user to select the right product.**

There is a lot of energy across the Seymour Midwest business as we look toward the future. We're excited about our prospective outlook and look forward to our continued partnership.

In the meantime, we look forward to seeing you at upcoming tradeshows and partner events. Don't hesitate to reach out if there is anything we can do to help you grow your business.

Your partnership and loyalty to Seymour Midwest and our family of brands is appreciated and valued!

SEYMOUR MIDWEST LEADERSHIP TEAM

Matthew Teevan - President & Chief Operating Officer

Randy Huss - Chief Financial Officer

Jason Henthorn - VP Logistics & Information Systems

TABLE OF CONTENTS

Limited Warranty Information	4
Our Brands	12-19
The Structron® Advantage	10-11

Shovels & Scoops

Caprock Shovels	45
Clean-Out Shovels	40
Drain Spades	32-36
Drain Spades / Mud & Muck	37
Garden Spades	38-39
Irrigation Shovels	46-47
Roofing Tools	48
Round Point / Digging	20-24
Round Point / Mud & Muck	25
Scoops - Aluminum	51-53
Scoops - Poly	54-55
Scoops - Steel	49-50
Specialty Shovels	48
Square Point / Mud & Muck	31
Square Point / Transfer	26-30
Transplant & Rice Shovels	47
Trenching Shovels - 28° / 14 Gauge	43-44
Trenching Shovels - 35° / 11 Gauge	41-42

Brooms

Brooms	135-139
--------------	---------

Coatings & Concrete Tools

Asphalt & Seal Coating Tools	156
Concrete Tools	159-160
EasySqueegee® Precision Application Squeegee	149
SpeedSqueegee™ HD	151-152
SureSpikes™ Footwear	150
Lutes	157-158
Squeegees - General / Roller / Asphalt	153-155

Edging / Weed & Brush Cutting

Hooks	123
Knives	125
Machetes	124
Scythe Blades	121
Snaths	120
Sod Lifter, Edger, Roller & Spreader	119
Weed & Brush Cutting	122

Extension Handles

Extension Handles	97
-------------------------	----

Fencing & Rings

Post Drivers & Pliers	161
Ring Fasteners	162-163

Firestarter

Firestarter	164-165
-------------------	---------

Forks

Bedding Forks	77
Hay, Straw & Ensilage	76
Spading & Manure Forks	75

Garden & Planting Tools

Garden Tools	133
Planting Tools	134

Hoes & Cultivators

Cultivators	74
Garden Hoes	72
Specialty Hoes	73

Irrigation Utility Tools

Irrigation Tools	142-146
------------------------	---------

Link® Replacement Handles

Link® Handles	98-118
---------------------	--------

Post Hole Diggers & Augers

Augers	59
Post Hole Diggers - Atlas Pattern	57
Post Hole Diggers - Hercules Pattern	56
Post Hole Diggers - Perfection	58
Post Hole Diggers - Gibbs / Buckeye / Lonestar Pattern	58

Pruning Tools

Pruning Saws	126
Hand Pruners	127
Hedge Shears	128
Anvil Loppers	129
Bypass Loppers	130-131
Tree Pruners & Fruit Picker	132

Rakes

Bow Rakes	64-65
Landscape Rakes	67-69
Poly Leaf Rakes	63
Specialty Rakes	70
Sports & Aquatic Rakes	71
Steel Tine Leaf Rakes	60-62
Stone / Level Head / Asphalt / Thatching Rakes	66

Replacement Parts

Replacement Parts	171
-------------------------	-----

Scrapers

Scrapers	78-79
----------------	-------

Snow Tools

Blizzard Buster® Snow Shovels & Pushers	140
Snow Shovels	141
Snow Pushers	141
Sleigh Scoop, Snow Squeegees & Roof Rakes	141

Sports Field Tools

Sports Field Tools	147-148
--------------------------	---------

Striking Tools

Axes - Double Bit Michigan & Pulaski	87
Axes - Single Bit Michigan, Boys & Camp	86
Best / S500 Industrial™	80
Better / S400 Jobsite™	81
Cutter & Pick Mattocks	89
Hammers - Cross-Pein	83
Hammers - Drilling	82
Hammers - Engineer	84
Hammers - Rip, Framing, Mallet & Dead Blow	84
Hammers - Sledge	85
Railroad Picks	90
Splitting Mauls	88
Utility Bars	92-93

Tampers & Wedges

Tampers & Wedges	91
------------------------	----

Wheelbarrows

Wheelbarrows	94-96
--------------------	-------



LIMITED WARRANTY

At Seymour Midwest we're proud to continue our more than **150 YEAR HERITAGE** by designing, manufacturing and selling tools offering outstanding performance year-after-year. We stand behind our products by extending to the **original purchaser a warranty that our products will be free from manufacturing defects in materials and workmanship during normal use**, subject to the qualifications listed below.

The typical life of a tool is determined by the conditions and level of use. Frequent, daily use will wear out a tool faster than infrequent, occasional use. **Defects in materials or workmanship typically arise early in the life of a tool.** Our **Limited Warranty** does not cover normal wear, lost parts, damage inflicted intentionally by the user, or failures due to accident, misuse, abuse, negligence, alteration or modification.

At Seymour Midwest's discretion, Seymour Midwest will replace or issue credit for any tool or accessory that our examination determines to be within this warranty. **Tools or accessories which are abused or worn out from normal use are excluded from this warranty.**

The length of warranty per tool series is listed in the chart below subject to the above criteria.

SERIES	WARRANTY
Structron® S800 SuperDuty™	Limited Lifetime
Structron® S700 SpringFlex™	
Structron® S600 Power™	
Structron® S600 Safety™	
Seymour® S550 Forged™	
Seymour® S500 Industrial™	
Midwest Rake® S550 Professional™	
Kenyon® S550 Irrigation™	
Seymour® S400 Jobsite™ / S400 Safety™ / S400 Workcrew™	Limited 15 Year
Seymour® S300 DuraLite™ / Toolite® S550 Mud & Muck™	Limited 5 Year
Seymour® S200™ / Link® Handles	Limited 1 Year
All Striking Tools	Limited 1 Year

**Certain exclusions apply to all series levels.*

How to Make a Warranty Claim: For all warranty claims, simply return the tool along with your dated **proof of purchase** to the place of purchase to initiate the replacement process. Please have the following information available when making a warranty claim: brand, item number, date and proof of purchase and explanation of how the tool broke.

Repair or replacement is the sole remedy available to the end-user or reseller.

Seymour Midwest expressly denies any liability for damage, injury or expense arising directly or indirectly as a result of the manufacture, sale, delivery, resale, repair, use or misuse of the products.

**For the most up-to-date warranty information, please visit SeymourMidwest.com.*

SEYMOUR MIDWEST BRAND HIERARCHY

SUPERIOR HEAVY-DUTY TOOLS
STRUCTRON®



Our brand hierarchy is intended to provide a **quick and easy visual reference** for where each of our products fit in our hierarchy while also providing **visual continuity at the point-of-purchase**.

STRUCTRON® & SEYMOUR® BLADE LABELS



The above blade labels illustrate the attributes for Structron® and Seymour®, our two primary long handled tool brands. Additionally, the blade labels summarize the Fiberglass, Safety and Hardwood options available by series.

MARKETS & CHANNELS SERVED



ASPHALT & SEAL COATING



LAKE MAINTENANCE



SPORTS FIELD & TURF



SNOW TOOLS



CONSUMER

MARKETS & CHANNELS SERVED



FROM OUR HANDS TO YOURS



REPLACEMENT HANDLES



INDUSTRIAL



IRRIGATION & MUNICIPALITIES



FENCING & RINGS



AGRICULTURAL



FIRESTARTER



COATINGS

CHANNELS SERVED

**SEYMOUR
MIDWEST**

100 YEARS SINCE 1872

There's a reason we don't look like other companies in our category – we still offer more tools for more specialty applications and markets.

Numerical Hierarchy: The brand hierarchy chart on page 5 is your “decoder ring” for the brands that call Seymour Midwest home. Our numerical hierarchy features a **Good / Better / Best / Premium** line-up. There's nothing one-size-fits-all about our tools, and making sure there is clear product differentiation as you move up and down the hierarchy means **easier more informed selling and purchasing**.

Organization:

- **Tools are organized by type to allow for ease of navigating the document:**
 - All Round Points are combined into four pages so you can easily survey all available options. The same goes for Square Point Shovels / Scoops / Rakes and the rest of our product line.
- **Tools are organized within their tool type by numerical hierarchy, we always start at the Premium (Structron®) level and work to our Good (\$200) product offering.**
 - S800 SuperDuty™ > S700 SpringFlex™ > S600 Power > S600 Safety™ > 550 Forged™ > S500 Industrial™...
- **We've continued with a grid format for easy-to-digest product attribute information.**

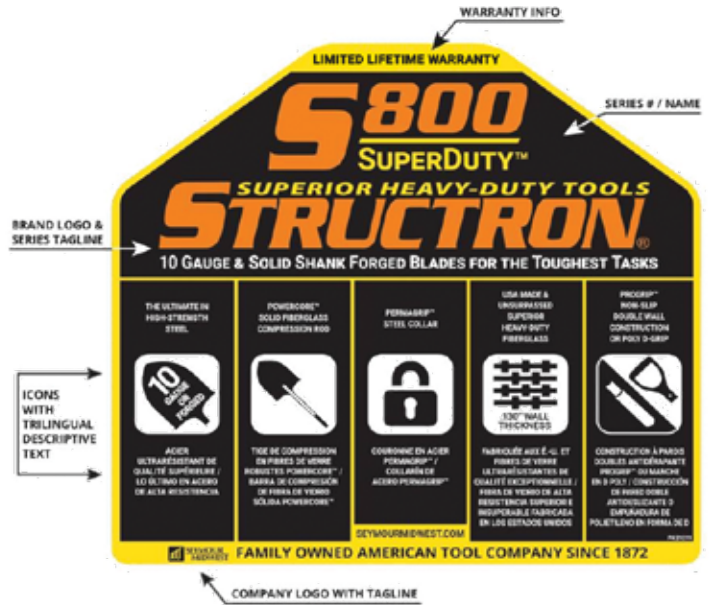

Toolmakers not Commodity Distributors: Ever notice why some tools feel stronger than others? Chances are it starts with our contoured precision lathe-turned American hardwood handles. **Since our founding in 1872 we've been Toolmakers.** That's a legacy and heritage that we strive to live up to everyday. We're not a manufacturer of a commodity and as such, we're willing to 'sign-up' to some very specific information when it comes to the tools we sell.

Toolmakers & Specifics: That's the second part of our **Partner Resource Guide** – the **specifics** of the tools we offer. The 'grids' on each page are full of the details that help all who use this document better understand what they're

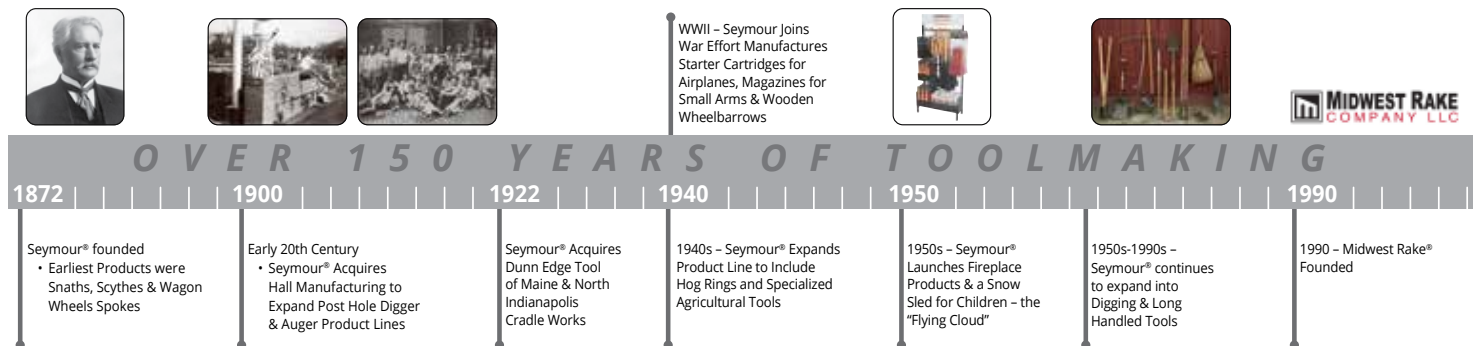

looking at. At the point-of-purchase, we've also invested in product labeling that we are confident will:

- **Provide a harmonious product appearance regardless of the series offered at the point-of-purchase.**
- Provide specific information, not generalities that will enable a more informed purchase. We're firm believers that a confused shopper or buyer isn't going to go for the more expensive item if there is nothing there to explain the difference.

Look for the blade labels on the tools throughout the document. Again, we're toolmakers so we're happy to sign-up to the specifics.

Seymour Spans the Globe: We're proud to sell our product around the world and have updated all tools that feature artwork with **trilingual English, Spanish & French** descriptions to best meet the needs of the market segments and global customers we serve.

It's All About the Brands: We're proud of our timeline over the past 150 years and of the brands that call Seymour Midwest home. While we have multiple brands, when they're displayed in a store or planogram it's imperative that **all brands look like they belong to the same family.**

All the Tools for Any Task on a Single Purchase Order!

Partners in Profit is a clever saying but with Seymour Midwest we provide a unique opportunity to expand our business together. **Coatings tools from Midwest Rake® are best in class and an excellent incremental opportunity. Firestarter, aquatic tools, Toolite® Mud & Muck™ shovels, Structron® S700 SpringFlex™, Sports Turf maintenance, the list goes on and on.** Need some help – let us know and we'll gladly assist.

Merchandising: Updated branding – make sure you have our latest artwork for your promotions & merchandising! Contact your Seymour Midwest Account Manager to learn more and ensure your content is up-to-date and meets proof of performance standards.



1872-2022

OVER 150 YEARS OF TOOLMAKING

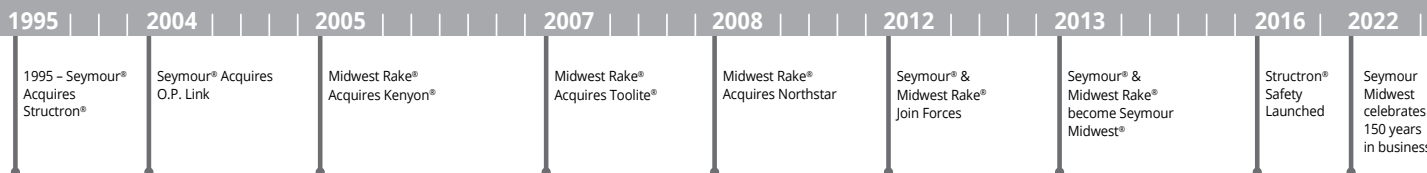

THE STRUCTRON® ADVANTAGE

BEST-IN-CLASS CONTRACTOR TOOLS

Since 1979 the Structron® brand has led the industry. Nearly indestructible, Structron® tools are always there when you need them the most.

ASSEMBLED IN THE USA
with American hands in Indiana.

POWERCORE™ SOLID FIBERGLASS COMPRESSION ROD

Extends 13 inches from the handle into the shank and blade for maximum strength at this critical stress point.

PROGRIP™ COMFORT GRIP

Made of durable textured vinyl with a non-slip surface for a secure grip with excellent shock-absorbing protection. Unique double-wall construction for greater durability. Weather resistant.

SAFETY YELLOW REINFORCED FIBERGLASS HANDLE

Strong yet lightweight industry leading .130" thick fiberglass handle provides maximum durability and visual impact and the strongest fiberglass.

HIGHEST QUALITY BLADES

- 10 Gauge • Forged • SpringFlex™ • 14 Gauge

PERMAGRIP™ STEEL COLLAR

A rivetless ring of steel connects the shovel neck, handle and fiberglass PowerCore™ rod, making it one solid unit. Provides the strongest head-to-handle connection.

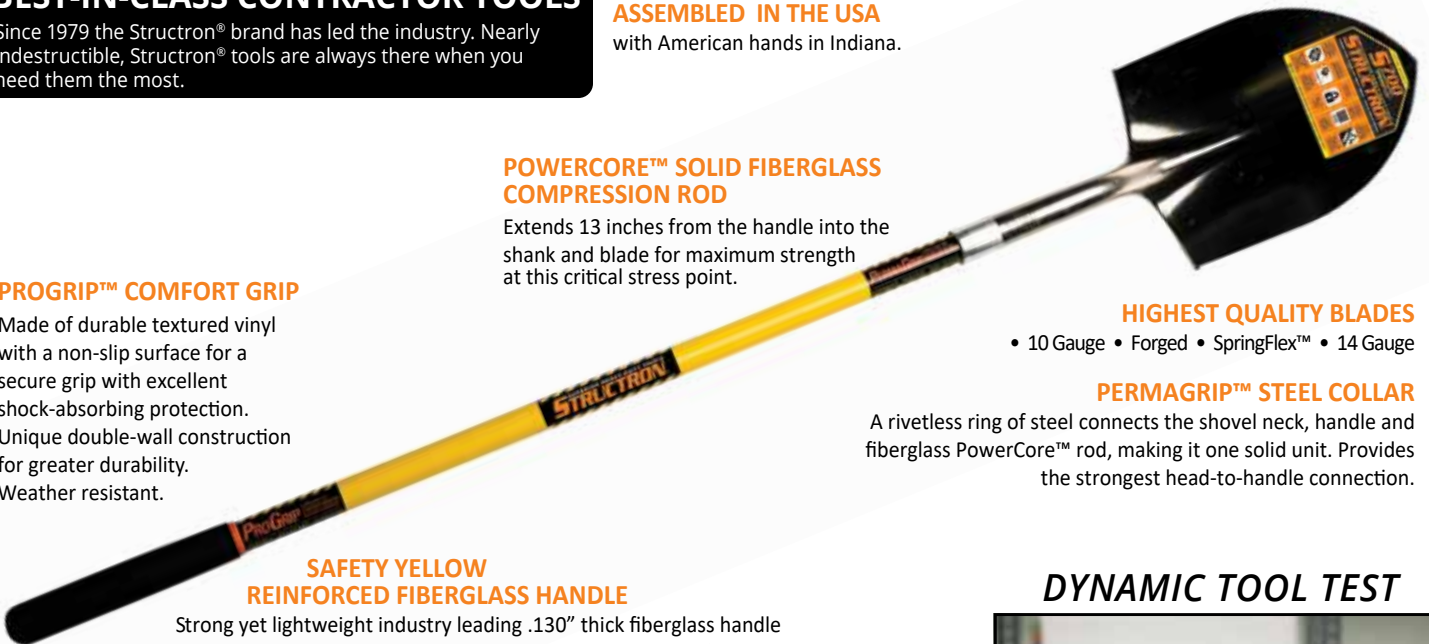

DYNAMIC TOOL TEST



TOTAL TOOL STRENGTH

SHOVEL WITH FIBERGLASS HANDLE	WEIGHT	HANDLE LENGTH	CONNECTION SYSTEM	HANDLE/HEAD INSERT	DYNAMIC TOOL TEST POUNDS TO FAILURE
49730 / S700	4.9 POUNDS	48"	CRIMPED FERRULE NO RIVET	FIBERGLASS POWERCORE™	250 POUNDS
COMPETITOR 1	5.0 POUNDS	49"	PRESS COLLAR	METAL TUBE	218 POUNDS
COMPETITOR 2	4.8 POUNDS	46.5"	PRESS COLLAR	METAL TUBE	202 POUNDS
COMPETITOR 3	4.5 POUNDS	47.5"	PRESS COLLAR	METAL TUBE	201 POUNDS

**UNSURPASSED, UNDISPUTED, UNRIVALED...
IN A WORD, UNDENIABLE.**

Meet the tools that have no equal: Structron®

Structron® is unlike any tool you've ever used or sold. Experience the power and **profitability** that comes with selling the Structron® family of tools.

You might even agree, it's unfair to the competition.

STRUCTRON[®] LABELS THAT IMPROVE COMMUNICATION OF SPECIFIC PRODUCT & SERIES ATTRIBUTES

WARRANTY INFO

LIMITED LIFETIME WARRANTY

S800
SUPERDUTY™
SUPERIOR HEAVY-DUTY TOOLS
STRUCTRON[®]
10 GAUGE & SOLID SHANK FORGED BLADES FOR THE TOUGHEST TASKS

SERIES # / NAME

BRAND LOGO & SERIES TAGLINE

ICONS WITH TRILINGUAL DESCRIPTIVE TEXT

<p>THE ULTIMATE IN HIGH STRENGTH STEEL</p> <p>ACIER ULTRA-RESISTANT DE QUALITE SUPERIEURE / LO ULTIMO EN ACERO DE ALTA RESISTENCIA.</p>	<p>POWERCORE™ SOLID FIBERGLASS COMPRESSION ROD</p> <p>TIGE DE COMPRESSION EN FIBRES DE VERRE ROBUSTES POWERCORE™ / BARRA DE COMPRESION DE FIBRA DE VIDRIO SOLIDA POWERCORE™</p>	<p>PERMAGRIP™ STEEL COLLAR</p> <p>COURONNE EN ACIER PERMAGRIP™ / COLLARIN DE ACERO PERMAGRIP™</p>	<p>USA MADE & UNSURPASSED SUPERIOR HEAVY-DUTY FIBERGLASS</p> <p>FABRIQUEE AUX E.-U. ET FIBRES DE VERRE ULTRA-RESISTANTES DE QUALITE EXCEPTIONNELLE / FIBRA DE VIDRIO DE ALTA RESISTENCIA SUPERIOR E INSUPERABLE FABRICADA EN LOS ESTADOS UNIDOS</p>	<p>PROGRIP™ NON-SLIP DOUBLE WALL CONSTRUCTION OR POLY D-GRIP</p> <p>CONSTRUCTION A PAROIS DOUBLES ANTIDERAPANTE PROGRIP™ OU MANCHE EN D POLY / CONSTRUCTION DE PAREE DOBLE ANTIDERAPANTE O EMPUÑADURA DE POLETILENO EN FORMA DE D</p>
---	---	---	---	---

SEYMOURMIDWEST.COM

FAMILY OWNED AMERICAN TOOL COMPANY SINCE 1872

COMPANY LOGO WITH TAGLINE

LIMITED LIFETIME WARRANTY

S700
SPRINGFLEX™
SUPERIOR HEAVY-DUTY TOOLS
STRUCTRON[®]
SPRING STEEL FLEXES BUT WON'T BREAK - THE ULTIMATE SHOVEL

<p>14 GAUGE HEAT TREATED HIGH CARBON POLISHED SPRING FLEX STEEL</p> <p>ACIER A RESSORTS FLEXIBLE A CARBONE POLI TRAITÉ A CHAUD, CALIBRE 14 / ACERO FLEXIBLE DE CALIBRE 14 POLIDO CON UN ALTO CONTENIDO DE TRATAMIENTO</p>	<p>POWERCORE™ SOLID FIBERGLASS COMPRESSION ROD</p> <p>TIGE DE COMPRESSION EN FIBRES DE VERRE ROBUSTES POWERCORE™ / BARRA DE COMPRESION DE FIBRA DE VIDRIO SOLIDA POWERCORE™</p>	<p>PERMAGRIP™ STEEL COLLAR</p> <p>COURONNE EN ACIER PERMAGRIP™ / COLLARIN DE ACERO PERMAGRIP™</p>	<p>USA MADE & UNSURPASSED SUPERIOR HEAVY-DUTY FIBERGLASS</p> <p>FABRIQUEE AUX E.-U. ET FIBRES DE VERRE ULTRA-RESISTANTES DE QUALITE EXCEPTIONNELLE / FIBRA DE VIDRIO DE ALTA RESISTENCIA SUPERIOR E INSUPERABLE FABRICADA EN LOS ESTADOS UNIDOS</p>	<p>PROGRIP™ NON-SLIP DOUBLE WALL CONSTRUCTION OR POLY D-GRIP</p> <p>CONSTRUCTION A PAROIS DOUBLES ANTIDERAPANTE PROGRIP™ OU MANCHE EN D POLY / CONSTRUCTION DE PAREE DOBLE ANTIDERAPANTE O EMPUÑADURA DE POLETILENO EN FORMA DE D</p>
---	---	---	---	---

SEYMOURMIDWEST.COM

FAMILY OWNED AMERICAN TOOL COMPANY SINCE 1872

LIMITED LIFETIME WARRANTY

S600
POWER
SUPERIOR HEAVY-DUTY TOOLS
STRUCTRON[®]
SUPERIOR STRENGTH FOUNDED ON EXCELLENCE IN DESIGN, ENGINEERING & MANUFACTURING

<p>HEAVY-DUTY 14 GAUGE TEMPERED STEEL WITH PROTECTIVE COATING</p> <p>ACIER REVENU DE CALIBRE 14 ULTRA-RESISTANT AVEC REVETEMENT PROTECTEUR / ACERO TEMPLADO DE CALIBRE 14 DE ALTA RESISTENCIA CON CAPA PROTECTORA</p>	<p>POWERCORE™ SOLID FIBERGLASS COMPRESSION ROD</p> <p>TIGE DE COMPRESSION EN FIBRES DE VERRE ROBUSTES POWERCORE™ / BARRA DE COMPRESION DE FIBRA DE VIDRIO SOLIDA POWERCORE™</p>	<p>PERMAGRIP™ STEEL COLLAR</p> <p>COURONNE EN ACIER PERMAGRIP™ / COLLARIN DE ACERO PERMAGRIP™</p>	<p>USA MADE & UNSURPASSED SUPERIOR HEAVY-DUTY FIBERGLASS</p> <p>FABRIQUEE AUX E.-U. ET FIBRES DE VERRE ULTRA-RESISTANTES DE QUALITE EXCEPTIONNELLE / FIBRA DE VIDRIO DE ALTA RESISTENCIA SUPERIOR E INSUPERABLE FABRICADA EN LOS ESTADOS UNIDOS</p>	<p>PROGRIP™ NON-SLIP DOUBLE WALL CONSTRUCTION OR POLY D-GRIP</p> <p>CONSTRUCTION A PAROIS DOUBLES ANTIDERAPANTE PROGRIP™ OU MANCHE EN D POLY / CONSTRUCTION DE PAREE DOBLE ANTIDERAPANTE O EMPUÑADURA DE POLETILENO EN FORMA DE D</p>
---	---	---	---	---

SEYMOURMIDWEST.COM

FAMILY OWNED AMERICAN TOOL COMPANY SINCE 1872

LIMITED LIFETIME WARRANTY

S600
SAFETY
SUPERIOR HEAVY-DUTY TOOLS
STRUCTRON[®]
BE SEEN, BE SAFE - HIGHEST VISIBILITY SUPERIOR STRENGTH TOOLS

<p>SAFETY GREEN FOR DAY AND RETROREFLECTIVE TAPE FOR NIGHT</p> <p>VERT DE SECURITE POUR LES TRAVAUX DE JOUR ET RUBAN REFLECTANT POUR LES TRAVAUX DE NUIT / SEGURIDAD VERDE PARA EL DIA Y BANDAS AUTOREFLECTANTES PARA LA NOCHE</p>	<p>HEAVY-DUTY 14 GAUGE TEMPERED STEEL WITH PROTECTIVE COATING</p> <p>ACIER REVENU DE CALIBRE 14 ULTRA-RESISTANT AVEC REVETEMENT PROTECTEUR / ACERO TEMPLADO DE CALIBRE 14 DE ALTA RESISTENCIA CON CAPA PROTECTORA</p>	<p>POWERCORE™ SOLID FIBERGLASS COMPRESSION ROD</p> <p>TIGE DE COMPRESSION EN FIBRES DE VERRE ROBUSTES POWERCORE™ / BARRA DE COMPRESION DE FIBRA DE VIDRIO SOLIDA POWERCORE™</p>	<p>USA MADE & UNSURPASSED SUPERIOR HEAVY-DUTY FIBERGLASS</p> <p>FABRIQUEE AUX E.-U. ET FIBRES DE VERRE ULTRA-RESISTANTES DE QUALITE EXCEPTIONNELLE / FIBRA DE VIDRIO DE ALTA RESISTENCIA SUPERIOR E INSUPERABLE FABRICADA EN LOS ESTADOS UNIDOS</p>	<p>PROGRIP™ NON-SLIP DOUBLE WALL CONSTRUCTION OR POLY D-GRIP</p> <p>CONSTRUCTION A PAROIS DOUBLES ANTIDERAPANTE PROGRIP™ OU MANCHE EN D POLY / CONSTRUCTION DE PAREE DOBLE ANTIDERAPANTE O EMPUÑADURA DE POLETILENO EN FORMA DE D</p>
--	---	---	---	---

SEYMOURMIDWEST.COM

FAMILY OWNED AMERICAN TOOL COMPANY SINCE 1872

STRUCTRON® - PREMIUM

SUPERIOR HEAVY-DUTY TOOLS STRUCTRON® S800 SUPERDUTY™

10 GAUGE & SOLID SHANK FORGED BLADES FOR THE TOUGHEST TASKS

We won't take it personally if you never buy forged shovels again. In fact, when your customers experience our one of a kind 10 Gauge shovels, we're confident they'll forget about forged as well.

Stronger, lighter and nearly unbreakable? The Structron® 10 Gauge **Caprock and Impact shovels** are game changers for tasks that have historically called for a forged tool.

Also up to the task and featuring premium Structron® fiberglass and our PowerCore™ for unrivaled strength the rest of the S800 SuperDuty™ line-up all feature the original forged blades.



LIMITED LIFETIME WARRANTY

S800 SUPERDUTY™

SUPERIOR HEAVY-DUTY TOOLS

STRUCTRON®

10 GAUGE & SOLID SHANK FORGED BLADES FOR THE TOUGHEST TASKS

THE ULTIMATE IN HIGH-STRENGTH STEEL	POWERCORE™ SOLID FIBERGLASS COMPRESSION ROD	PERMACRIP™ STEEL COLLAR	USA MADE & UNSPRESSED SUPERIOR HEAVY-DUTY FIBERGLASS	PROGRIP™ NON-SLIP DOUBLE WALL CONSTRUCTION OR POLY D-GRIP
ACIER ULTRARÉSISTANT DE QUALITÉ SUPÉRIEURE LO ULTIMO EN ACERO DE ALTA RESISTENCIA	TIGE DE COMPRESSION EN FIBRES DE VERRE ROBUSTES POWERCORE™ BARRA DE COMPRESION DE FIBRA DE VIDRIO SOLIDA POWERCORE™	COURONNE EN ACIER PERMACRIP™ / COLLAIN DE ACIER PERMACRIP™	FABRIQUÉE AUX É.-U. ET FIBRES DE VERRE ULTRARÉSISTANTES DE QUALITÉ EXCEPTIONNELLE / FIBRA DE VIDRIO DE ALTA RESISTENCIA SUPERIOR E INSUPERABLE FABRICADA EN LOS ESTADOS UNIDOS	CONSTRUCTION À PAROIS DOUBLES ANTIDÉBRÛTANTE PROGRIP™ OU MANCHE EN D POLY / CONSTRUCCION DE PARED DOBLE ANTIDESLIZANTE O SOPORTE EN FORMA DE D POLIETILENO

SEYMOURMIDWEST.COM

FAMILY OWNED AMERICAN TOOL COMPANY SINCE 1872

SUPERIOR HEAVY-DUTY TOOLS STRUCTRON® S700 SPRINGFLEX™

SPRING STEEL FLEXES BUT WON'T BREAK - THE ULTIMATE SHOVEL

Some tools are just plain superior and the S700 SpringFlex™ are those tools.

When tasked with creating **the ultimate shovel** our engineers specified **SpringFlex™**. Manufactured to our **exacting standards** and exhibiting the attributes of spring steel, paired with the strength of the hallmark Structron® Solid Fiberglass Compression Rod, these eleven shovels bury everything else out there. Backed by a limited lifetime warranty, these tools are the textbook definition of "investment grade."

SPRINGFLEX™



LIMITED LIFETIME WARRANTY

S700 SPRINGFLEX™

SUPERIOR HEAVY-DUTY TOOLS

STRUCTRON®

SPRING STEEL FLEXES BUT WON'T BREAK - THE ULTIMATE SHOVEL

10 GAUGE HEAT TREATED HIGH CARBON POLISHED SPRING FLEX STEEL	POWERCORE™ SOLID FIBERGLASS COMPRESSION ROD	PERMACRIP™ STEEL COLLAR	USA MADE & UNSPRESSED SUPERIOR HEAVY-DUTY FIBERGLASS	PROGRIP™ NON-SLIP DOUBLE WALL CONSTRUCTION OR POLY D-GRIP
ACIER À RESORTS FLEXIBLE À CARBONE POLI TRAITÉ À CHAUD, CALIBRE 14 / ACERO FLEXIBLE RECÁLIBRE 14 FRÍO CON UN ALTO CONTENIDO DE CARBONO TRATADO TÉRMICAMENTE	TIGE DE COMPRESSION EN FIBRES DE VERRE ROBUSTES POWERCORE™ BARRA DE COMPRESION DE FIBRA DE VIDRIO SOLIDA POWERCORE™	COURONNE EN ACIER PERMACRIP™ / COLLAIN DE ACIER PERMACRIP™	FABRIQUÉE AUX É.-U. ET FIBRES DE VERRE ULTRARÉSISTANTES DE QUALITÉ EXCEPTIONNELLE / FIBRA DE VIDRIO DE ALTA RESISTENCIA SUPERIOR E INSUPERABLE FABRICADA EN LOS ESTADOS UNIDOS	CONSTRUCTION À PAROIS DOUBLES ANTIDÉBRÛTANTE PROGRIP™ OU MANCHE EN D POLY / CONSTRUCCION DE PARED DOBLE ANTIDESLIZANTE O SOPORTE EN FORMA DE D POLIETILENO

SEYMOURMIDWEST.COM

FAMILY OWNED AMERICAN TOOL COMPANY SINCE 1872

SUPERIOR HEAVY-DUTY TOOLS
STRUCTRON[®] **S600**
POWER

SUPERIOR STRENGTH FOUNDED ON EXCELLENCE IN DESIGN, ENGINEERING & MANUFACTURING

Looking to Differentiate? Guaranteed to Outperform!

Don't ever confuse Structron[®] with other products in the market. The same goes for the S600 Power[™] series. 14 Gauge blades are out there, but the competition does not offer a **Solid Fiberglass Compression Rod** - what we call the **PowerCore[™]**.

PermaGrip[™] - A rivetless ring of steel connects the shovel neck, handle and fiberglass insert, making it one solid unit. Provides the strongest head-to-handle connection.



LIMITED LIFETIME WARRANTY

S600
POWER
SUPERIOR HEAVY-DUTY TOOLS
STRUCTRON[®]
SUPERIOR STRENGTH FOUNDED ON EXCELLENCE IN DESIGN, ENGINEERING & MANUFACTURING

<p>HEAVY-DUTY 14 GAUGE TEMPERED STEEL WITH PROTECTIVE COATING</p> <p>ACIER REVENI DE CALIBRE 14 ULTRA-RESISTANT AVEC REVÊTEMENT PROTÉCTEUR / ACIERO TEMPALADO DE CALIBRE 14 DE ALTA RESISTENCIA CON CAPA PROTECTORA</p>	<p>POWERCORE[™] SOLID FIBERGLASS COMPRESSION ROD</p> <p>TIGE DE COMPRESSION EN FIBRES DE VERRE / ROULETES POWERCORE[™] / BARRA DE COMPRESSION DE FIBRA DE VIDRIO SÓLIDA POWERCORE[™]</p>	<p>PERMAGRIP[™] STEEL COLLAR</p> <p>COLONNE EN ACIER PERMAGRIP[™] / COLLARIN DE ACERO PERMAGRIP[™]</p>	<p>USA MADE & UNIMPASSED SUPERIOR HEAVY-DUTY FIBERGLASS</p> <p>FABRIQUÉE AUX É.-U. ET FIBRES DE VERRE ULTRA-RESISTANTES DE QUALITÉ EXCEPTIONNELLE / FIBRA DE VIDRIO DE ALTA RESISTENCIA SUPERIORE E IMPERABLE FABRICADA EN LOS ESTADOS UNIDOS</p>	<p>PROGRIP[™] NON-SLIP DOUBLE WALL CONSTRUCTION OR POLY D-GRIP</p> <p>CONSTRUCTION À PAROIS DOUBLES ANTIDÉSSANTE PROGRIP[™] OU MANCHE EN D POLY / CONSTRUCTION DE PAREO DOBLE ANTIDÉSSANTE O EMPUÑADURA DE PÓLITILENO EN FORMA DE D</p>
---	---	---	---	---

SEYMOURMIDWEST.COM
FAMILY OWNED AMERICAN TOOL COMPANY SINCE 1872

SUPERIOR HEAVY-DUTY TOOLS
STRUCTRON[®] **S600**
SAFETY

BE SEEN, BE SAFE - HIGHEST VISIBILITY SUPERIOR STRENGTH TOOLS

Our Structron[®] Safety[™] line is an excellent addition to any construction crew looking to **increase worker visibility and safety during daylight and nighttime hours**. Like high visibility safety clothing, Structron[®] Safety[™] tools are safety green and utilize (2) 3M[®] Series 3300 tape accents made of **highly retroreflective microprismatic markings, designed to enhance visibility and detection and exceed the reflectivity values of ASTM Type III.**



LIMITED LIFETIME WARRANTY

S600
SAFETY
SUPERIOR HEAVY-DUTY TOOLS
STRUCTRON[®]
BE SEEN, BE SAFE - HIGHEST VISIBILITY SUPERIOR STRENGTH TOOLS

<p>SAFETY GREEN FOR DAY AND RETROREFLECTIVE TAPE FOR NIGHT</p> <p>VERT DE SÉCURITÉ POUR LES TRAVAIL DE JOUR ET BANDES RÉFLÉCHISSANT POUR LES TRAVAIL DE NUIT / SEGURIDAD VERDE PARA EL DÍA Y BANDAS AUTOREFLECTANTES PARA LA NOCHE</p>	<p>HEAVY-DUTY 14 GAUGE TEMPERED STEEL WITH PROTECTIVE COATING</p> <p>ACIER REVENI DE CALIBRE 14 ULTRA-RESISTANT AVEC REVÊTEMENT PROTÉCTEUR / ACIERO TEMPALADO DE CALIBRE 14 DE ALTA RESISTENCIA CON CAPA PROTECTORA</p>	<p>POWERCORE[™] SOLID FIBERGLASS COMPRESSION ROD</p> <p>TIGE DE COMPRESSION EN FIBRES DE VERRE / ROULETES POWERCORE[™] / BARRA DE COMPRESSION DE FIBRA DE VIDRIO SÓLIDA POWERCORE[™]</p>	<p>USA MADE & UNIMPASSED SUPERIOR HEAVY-DUTY FIBERGLASS</p> <p>FABRIQUÉE AUX É.-U. ET FIBRES DE VERRE ULTRA-RESISTANTES DE QUALITÉ EXCEPTIONNELLE / FIBRA DE VIDRIO DE ALTA RESISTENCIA SUPERIORE E IMPERABLE FABRICADA EN LOS ESTADOS UNIDOS</p>	<p>PROGRIP[™] NON-SLIP DOUBLE WALL CONSTRUCTION OR POLY D-GRIP</p> <p>CONSTRUCTION À PAROIS DOUBLES ANTIDÉSSANTE PROGRIP[™] OU MANCHE EN D POLY / CONSTRUCTION DE PAREO DOBLE ANTIDÉSSANTE O EMPUÑADURA DE PÓLITILENO EN FORMA DE D</p>
--	---	---	---	---

SEYMOURMIDWEST.COM
FAMILY OWNED AMERICAN TOOL COMPANY SINCE 1872

SEYMOUR® S550 FORGED

SOLID SHANK FORGED BLADES

If the "classic" tool exists, it's a forged blade with a hardwood handle – that's S550 Forged™.

Tools in this category include:

- Shovels
- Drain Spades
- Bow Rakes
- Specialty Tools (such as Eye Hoes and SuperScrapers™)



SEYMOUR® S500 INDUSTRIAL™

HEAVY-DUTY INDUSTRIAL GRADE TOOLS

Two words describe the S500 series: **Industrial & Specialized.**

Industrial means these tools will be in the **Industrial Supply houses** along with the other 12 and 14 Gauge blades.

Specialized can be found in the sheer volume of items we offer that can't be found elsewhere in the market. Take scoops for example: multiple handle lengths & heavy aluminum blades mean you're selling the absolute best when you carry S500 scoops. The same goes for other **task specific tools**: Steel Augers, Specialty Post Hole Diggers and Fencing Tools. **Our extended socket with extended boot step shovels also call S500 Industrial™ home.**



SEYMOUR® S400 JOBSITE

SEYMOUR® S400 WORKCREW™

CONTRACTOR GRADE CONSTRUCTION, COMPONENTS & CRAFTSMANSHIP

Dedicated labeling for both fiberglass and hardwood models ensure that at the point-of-purchase the product are clearly explained – nothing cookie cutter about the labeling or the S400 Jobsite™ tools!

Fiberglass tools feature:

- **PermaGrip™** – A rivetless ring of steel connects the shovel neck, handle and fiberglass insert, making it one solid unit. Provides the strongest head-to-handle connection.
- Contractor grade fiberglass handles with **heavy-duty and durable fiberglass insert for added strength.**



S400 Jobsite™ and S400 Workcrew™ are an extremely comprehensive assortment of tools. Shovels, Rakes, Scoops, Post Hole Diggers, Brooms, Pruning Tools...S400 Jobsite™ is up to any task!



SEYMOUR® S400 SAFETY

BE SEEN, BE SAFE - HIGH VISIBILITY CONTRACTOR GRADE TOOLS

Just like our S400 Jobsite™ tools, the S400 Safety™ feature:

- **PermaGrip™**- the same head-to-handle connection we use on Structron®, no skimping on strength here.
- Contractor grade fiberglass handles with **heavy-duty and durable fiberglass insert for added strength.**
- 16 Gauge blades for shovels.



SEYMOUR® S300 DURALITE™

DURABLE TOOLS THAT MEAN BUSINESS

Shovels, Rakes, Post Hole Diggers, Garden Tools, Wheelbarrows and Snow Tools... S300 DuraLite™ occupies a strong footprint in our assortment as durable tools.

Fiberglass tools feature:

- **PermaGrip™** – A rivetless ring of steel connects the shovel neck, handle and hardwood reinforcing rod insert, making it one solid unit. Provides the strongest head-to-handle connection.



S300 DuraLite™ offers exceptional value, **absolute continuity with the rest of the Seymour Midwest brand levels from a planogram perspective** and as always worthy of wearing the Seymour® name!



SEYMOUR® S200

Our 'good' offering is truly special. **Contoured handles with a clear lacquer finish** are features that are second to none. And towards our goal of providing a coherent merchandising platform regardless of the series displayed in your store, **we've invested in blade labels that follow the updated Seymour Midwest format and a series pad print on the handle.** We wouldn't put our name on it if it wasn't good enough to be a Seymour® tool.



MIDWEST RAKE®

The best way to **incrementally grow your business with Seymour Midwest** – add the Midwest Rake specialty coatings tools that are trusted by coatings experts and concrete decor artisans worldwide.

- Innovative high quality patented tools for the coatings industry.
- Widest selection of pro-grade tools and supplies for applying coatings and decorative concrete applications.
- Smart new merchandising solutions and displays.
- Dedicated and knowledgeable sales support to help you grow your business.
- All the tools for any task on a single purchase order.

To request the Midwest Rake® Coatings Catalog – please call 844-SEYMOUR, email us at Customer.Service@SeymourMidwest.com, or visit <https://seymourmidwest.com/catalogs-brochures>.

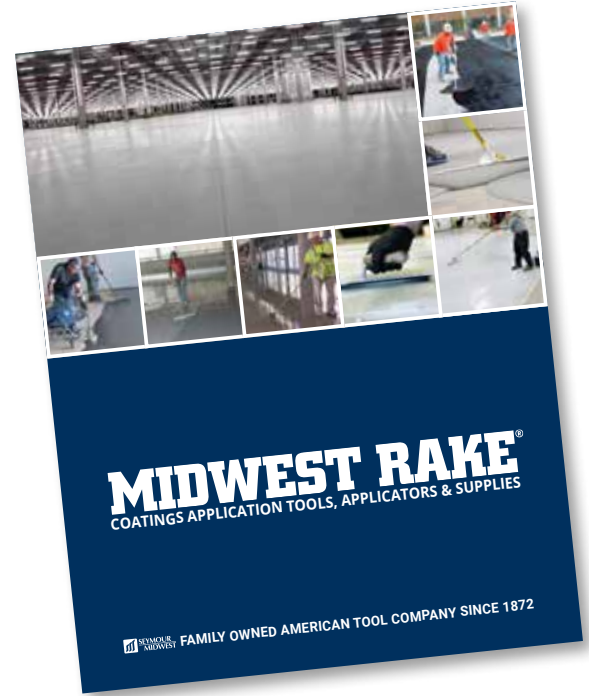

MIDWEST RAKE® COATINGS APPLICATION TOOLS & SUPPLIES

EASYSQUEEGEE®

CLEANABLE & REUSABLE US PATENT 10,166,925

PRECISION APPLICATION SQUEEGEE SYSTEM

INTELLIGENT BLADE IDENTIFICATION

Blade color identifies with 90% accuracy

SELF-LEVELING BLADES

Accurate and precise Wet Film Thickness

SELF-LOCATING BLADES

Designed to ensure industry leading accuracy

PROTECTED THROAT AND FASTENERS

Eliminates material contact with threads

STEEL THUMB SCREWS

Facilitates Quick Change Release Technology for cleanliness

BLADE STYLE	BLADE WIDTH / PART NUMBER		SAMPLE PROJECT APPLICATIONS
	18"	24"	
FRAME Attachment used to hold blade	78055	78056	
FLAT FLEXIBLE	78060	78061	Do you require a thinner most flexible blade for your coating application? Or do you prefer building up a coating?
FLAT STIFF	78063	78064	Do you require a blade which is cost effective for your application?
5-7 WFT MILS WFR: 230-235 / GAL	78068	78067	Need to apply 5-7 mils wet film thickness? Consider our 5-7 mils blade for your application.
8-12 WFT MILS WFR: 230-235 / GAL	78069	78060	Need to get 200 gallons of 2000 sq ft of concrete? Consider our 8-12 mils blade for your application.
15-20 WFT MILS WFR: 230-235 / GAL	78062	78063	Applying a decorative 15-20 mils wet film thickness? Consider our 15-20 mils blade for your application.
25-30 WFT MILS WFR: 230-235 / GAL	78065	78066	Looking to apply decorative 25-30 mils wet film thickness? Consider our 25-30 mils blade for your application.
40-45 WFT MILS WFR: 230-235 / GAL	78068	78069	Are you applying 40-45 mils of wet film thickness? Consider our 40-45 mils blade for your application.
50-60 WFT MILS WFR: 230-235 / GAL	78071	78072	Need to apply 50-60 mils of wet film thickness? Consider our 50-60 mils blade for your application.

WFT = WET FILM THICKNESS | WFR = WET FILM SPREAD RATE | GAL = GALLON

- WIDEST SELECTION OF PRO-GRADE TOOLS AND SUPPLIES FOR APPLYING COATINGS
- DEDICATED & KNOWLEDGEABLE LOCAL SALES SUPPORT TO HELP YOU GROW YOUR BUSINESS
- NEXT DAY SHIPPING AVAILABLE

SPIKED SHOES

RAKES (CAM® / GAUGE)

SQUEEGEES

SPIKED ROLLERS

SPREADER / SMOOTHER

ASSURANCE™ COVERS

TROWELS

MIXING EQUIPMENT

FAMILY OWNED AMERICAN TOOL COMPANY SINCE 1872



TOOLS FOR PROFESSIONAL LANDSCAPERS & IRRIGATION CONTRACTORS

Polymer, fiberglass, hardwood – 28° and 35° angle options...that adds up to a lot of trenching shovel options, 24 to be exact and we wouldn't have it any other way. Everyone has their preference when it comes to trenching shovels and **we're here to make sure you have the exact option you, your crew and the job require.**

The same logic and **completeness of product line** is the hallmark of the Kenyon S550 Irrigation™ offering.

Kenyon is the home of specialized irrigation and landscaping tools.



Toolite® S550

Mud & Muck

MUD & MUCK RELEASING BLADES

“Releasing” Perforated Blade Engineered for Working with Saturated Materials & Sifting

- Breaks Suction When Working in Wet Soils.
- Allows Excess Water to Drain Through Perforations.
- Has Less Surface Area Decreasing the Tendency for Wet Soil to Adhere to the Blade.
- Blade Design is Lightweight, Ergonomic & Will Cause Less Fatigue.
- Superior Tool for Digging in Mud, Muck, Clay & Water Saturated Materials.
- Superior Tool for Sifting Debris from Sand, Gravel & Grain.
- Polymer, Fiberglass & Hardwood Handles.



LINK® HANDLES

AMERICAN-MADE HARDWOOD REPLACEMENT HANDLES



OVER 8,000 HANDLE STYLES AVAILABLE

LINK® HANDLES vs. COMPETITIVE



25% Larger Blank	vs.	Thin, Flat Board
Compound Curves	vs.	Smoothed & Rounded
Ergonomics Engineered for Application	vs.	Shaped Handle



Our handle shape always works with the user. The handle becomes an extension of the body to provide better comfort, control, and safety.

AMERICAN HICKORY & OTHER AMERICAN HARDWOODS

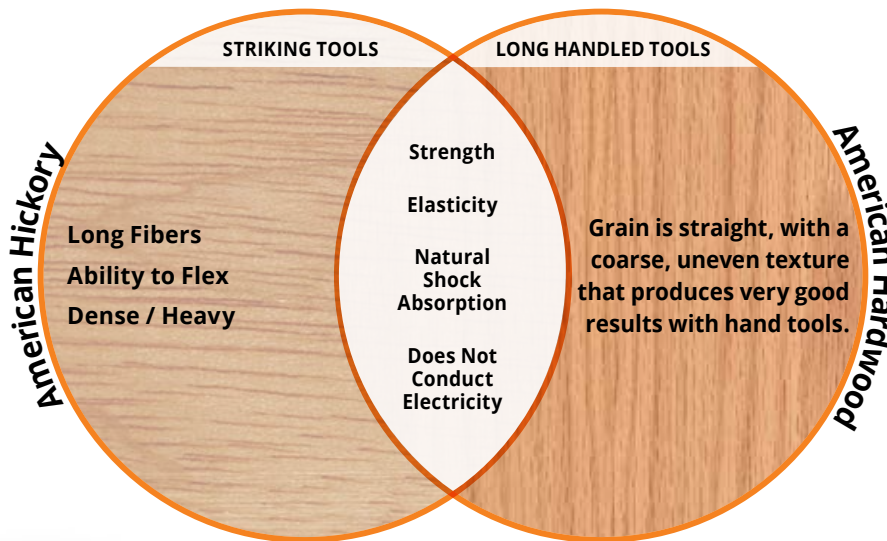

IDEAL GEOGRAPHY FOR:

- SOIL
- RAINFALL
- SUNSHINE

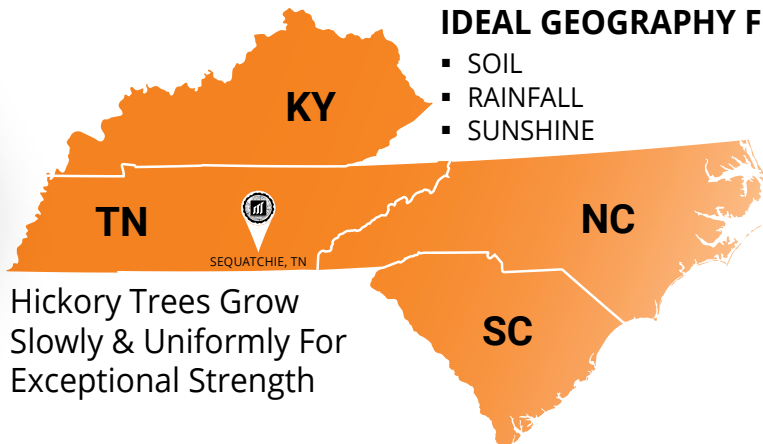

Hickory Trees Grow Slowly & Uniformly For Exceptional Strength

SHOVELS - ROUND POINT / DIGGING



SUPER SHOVEL®: BEST FOR TOUGH SOIL
 Our Super Shovel® tools have “cutting teeth” to penetrate hard-packed, rocky and clay soils and also chop through roots and sod. They’re 100% made in Seymour, Indiana USA.

WHY CLOSED BACK?

Closed back shovels have welded backplates to prevent material build-up. These plates also provide extra strength.

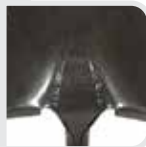

#	SMW # LEGACY #	SERIES	WARRANTY	DESCRIPTION	HEAD STYLE	HEAD-TO-HANDLE	HANDLE TYPE	GRIP	UPC	PACK QTY	PACK WEIGHT
1	49770 STR-S800	S800 SuperDuty™	Limited Lifetime	Forged #2 / 9.5" x 11.5"	Forward Turned Step	PowerCore™ & PermaGrip™	48" Premium Fiberglass	ProGrip™	036723008023	4	26.4
2	49731 STR-S700D	S700 SpringFlex™	Limited Lifetime	14 Gauge #2 / 9.5" x 11.5"	Spring Steel Rear Rolled Step	PowerCore™ & PermaGrip™	29" Premium Fiberglass	Poly D	036723017001	4	17.6
3	49730 STR-S700	S700 SpringFlex™	Limited Lifetime	14 Gauge #2 / 9.5" x 11.5"	Spring Steel Rear Rolled Step	PowerCore™ & PermaGrip™	48" Premium Fiberglass	ProGrip™	036723007002	4	20.8
4	49561 STR-S600D	S600 Power™	Limited Lifetime	14 Gauge #2 / 9.5" x 11.5"	Forward Turned Step	PowerCore™ & PermaGrip™	29" Premium Fiberglass	Poly D	036723016004	4	19.2
5	49560 STR-S600	S600 Power™	Limited Lifetime	14 Gauge #2 / 9.5" x 11.5"	Forward Turned Step	PowerCore™ & PermaGrip™	48" Premium Fiberglass	ProGrip™	036723006005	4	22.4
5	49744 STR-S712	S600 Power™	Limited Lifetime	14 Gauge #2 / 9.5" x 11.5"	Forward Turned Step with Closed Back	PowerCore™ & PermaGrip™	48" Premium Fiberglass	ProGrip™	036723507120	4	20.8
5	49599	S600 Power™	Limited Lifetime	14 Gauge #2 / 9.5" x 11.5"	Forward Turned Step with Closed Back	PowerCore™ & PermaGrip™	48" Premium Fiberglass Core	ProGrip™	046385495994	4	19.2
6	49759	S600 Safety™	Limited Lifetime	14 Gauge #2 / 9.5" x 11.5"	Forward Turned Step	PowerCore™ & PermaGrip™	29" Premium Fiberglass with 3M® Retroreflective Tape	Poly D	046385497592	4	19.2
7	49750	S600 Safety™	Limited Lifetime	14 Gauge #2 / 9.5" x 11.5"	Forward Turned Step	PowerCore™ & PermaGrip™	48" Premium Fiberglass with 3M® Retroreflective Tape	ProGrip™	046385497509	4	27.2
8	49631 STR-S710D	S600 Power™	Limited Lifetime	14 Gauge / 9" x 11"	Forward Turned Step "Cutting Teeth"	PowerCore™ & PermaGrip™	29" Premium Fiberglass	Poly D	036723017100	4	21.6
9	49630 STR-S710	S600 Power™	Limited Lifetime	14 Gauge / 9" x 11"	Forward Turned Step "Cutting Teeth"	PowerCore™ & PermaGrip™	48" Premium Fiberglass	ProGrip™	036723007101	4	22.4



#	SMW # LEGACY #	SERIES	WARRANTY	DESCRIPTION	HEAD STYLE	HEAD-TO-HANDLE	HANDLE TYPE	GRIP	UPC	PACK QTY	PACK WEIGHT
1	49171 SV-DR52	S550 Forged™	Limited Lifetime	Forged #2 / 9.5" x 11.5"	Forward Turned Step	Solid Steel Rivet	27" Precision Lathe Turned American Hardwood	Steel D	046385491712	4	28.8
2	49170 SV-LR50	S550 Forged™	Limited Lifetime	Forged #2 / 9.5" x 11.5"	Forward Turned Step	Solid Steel Rivet	48" Precision Lathe Turned American Hardwood	-	046385491705	4	37.2
3	45141	S500 Industrial™	Limited Lifetime	14 Gauge #2 / 9.5" x 11.5"	PowerSocket™ & Forward Turned Boot Step	Fiberglass Insert & PermaGrip™	29" Industrial Grade Fiberglass	Poly D	046385451419	4	20.1
4	45140	S500 Industrial™	Limited Lifetime	14 Gauge #2 / 9.5" x 11.5"	PowerSocket™ & Forward Turned Boot Step	Fiberglass Insert & PermaGrip™	48" Industrial Grade Fiberglass	ProGrip™	046385451402	4	20.9
5	45011	S500 Industrial™	Limited Lifetime	14 Gauge #2 / 9.5" x 11.5"	PowerSocket™ & Forward Turned Boot Step	Two Solid Steel Rivets	29" Precision Lathe Turned American Hardwood	Steel D	046385450115	4	21.3
6	45010	S500 Industrial™	Limited Lifetime	14 Gauge #2 / 9.5" x 11.5"	PowerSocket™ & Forward Turned Boot Step	Two Solid Steel Rivets	48" Precision Lathe Turned American Hardwood	ProGrip™	046385450108	4	20.8
7	45000	S500 Industrial™	Limited Lifetime	14 Gauge #2 / 9.5" x 11.5"	PowerSocket™ & Forward Turned Step	Two Solid Steel Rivets	48" Precision Lathe Turned American Hardwood	-	046385450009	4	20.2

SHOVELS - ROUND POINT / DIGGING



SUPER SHOVEL®: BEST FOR TOUGH SOIL

Our Super Shovel® tools have “cutting teeth” to penetrate hard-packed, rocky and clay soils and also chop through roots and sod. They’re 100% made in Seymour, Indiana USA.

WHY CLOSED BACK?

Closed back shovels have welded backplates to prevent material build-up. These plates also provide extra strength.



#	SMW # LEGACY #	SERIES	WARRANTY	DESCRIPTION	HEAD STYLE	HEAD-TO-HANDLE	HANDLE TYPE	GRIP	UPC	PACK QTY	PACK WEIGHT
1	45100	S500 Industrial™	Limited Lifetime	14 Gauge #2 / 9.5" x 11.5"	Forward Turned Step	Fiberglass Insert & PermaGrip™	48" Industrial Grade Fiberglass	ProGrip™	046385451006	4	19.0
1	45110	S500 Industrial™	Limited Lifetime	14 Gauge #2 / 9.5" x 11.5"	Forward Turned Step with Closed Back	Fiberglass Insert & PermaGrip™	48" Industrial Grade Fiberglass	ProGrip™	046385451105	4	19.8
2	49331 SV-DR32	S500 Industrial™	Limited Lifetime	14 Gauge #2 / 9.5" x 11.5"	Forward Turned Step	Extended 11" Tab Socket with Two Solid Steel Rivets	30" Precision Lathe Turned American Hardwood	Steel D	031365121000	6	27.6
2	49338	S500 Industrial™	Limited Lifetime	14 Gauge #2 / 9.5" x 11.5"	Forward Turned Step	Extended 11" Tab Socket with Two Solid Steel Rivets	39" Precision Lathe Turned American Hardwood	Steel D	046385493389	6	35
3	49330 SV-LR30	S500 Industrial™	Limited Lifetime	14 Gauge #2 / 9.5" x 11.5"	Forward Turned Step	Extended 11" Tab Socket with Two Solid Steel Rivets	48" Precision Lathe Turned American Hardwood	-	031365120034	6	31.2
3	49344 SV-LR30CB	S500 Industrial™	Limited Lifetime	14 Gauge #2 / 9.5" x 11.5"	Forward Turned Step with Closed Back	Extended 11" Tab Socket with Two Solid Steel Rivets	48" Precision Lathe Turned American Hardwood	-	031365120324	6	33.6
4	49340 SV-LR34	S500 Industrial™	Limited Lifetime	14 Gauge #2 / 9.5" x 11.5"	Rear Rolled Step	Extended 11" Tab Socket with Two Solid Steel Rivets	48" Precision Lathe Turned American Hardwood	-	031365121482	6	28.8
5	49164 SV-DT35	S500 Industrial™	Limited Lifetime	14 Gauge / 9" x 11"	Forward Turned Step "Cutting Teeth"	Power Collar & Solid Steel Rivet	29" Precision Lathe Turned American Hardwood	Steel D	031365120300	6	28.8
6	49163 SV-LT34	S500 Industrial™	Limited Lifetime	14 Gauge / 9" x 11"	Forward Turned Step "Cutting Teeth"	Power Collar & Solid Steel Rivet	48" Precision Lathe Turned American Hardwood	-	031365120317	6	28.8

ROUND POINT / DIGGING - SHOVELS



#	SMW # LEGACY #	SERIES	WARRANTY	DESCRIPTION	HEAD STYLE	HEAD-TO-HANDLE	HANDLE TYPE	GRIP	UPC	PACK QTY	PACK WEIGHT
1	49451 SV-DR42	S400 Jobsite™	Limited 15 Year	16 Gauge #2 / 9.5" x 11.5"	Forward Turned Step	Fiberglass Insert & PermaGrip™	26" Professional Grade Fiberglass	Poly D	031365121048	6	21.6
2	49450 SV-LR40	S400 Jobsite™	Limited 15 Year	16 Gauge #2 / 9.5" x 11.5"	Forward Turned Step	Fiberglass Insert & PermaGrip™	46" Professional Grade Fiberglass	Cushion	031365120072	6	21.6
3	49920	S400 Safety™	Limited 15 Year	16 Gauge #2 / 9.5" x 11.5"	Forward Turned Step	Fiberglass Insert & PermaGrip™	48" Professional Grade Fiberglass with 3M® Retroreflective Tape	Cushion	046385499206	6	21.6
4	49150 SV-LR20	S400 Jobsite™	Limited 15 Year	16 Gauge #2 / 9.5" x 11.5"	Forward Turned Step	Power Collar & Solid Steel Rivet	48" Precision Lathe Turned Hardwood	-	031365120058	6	26.4
5	49151 SV-DR22	S400 Jobsite™	Limited 15 Year	16 Gauge #2 / 9.5" x 11.5"	Forward Turned Step	Power Collar & Solid Steel Rivet	30" Precision Lathe Turned Hardwood	Steel D	031365121017	6	22.8
6	49351 SV-DRMP	S400 Jobsite™	Limited 15 Year	MiniPro Shovel 6" x 8"	Forward Turned Step	Solid Steel Rivet	12" Precision Lathe Turned Hardwood	Poly D	031365121086	6	13.2
7	49352 SV-DRMPFG	S400 Jobsite™	Limited 15 Year	MiniPro Shovel 6" x 8"	Forward Turned Step	PermaGrip™	12" Professional Grade Fiberglass	Poly D	031365121116	6	11.7
8	45200	S400 Workcrew™	Limited 15 Year	15 Gauge #2 / 9.5" x 11.5"	Forward Turned Step & 11" Tab Socket	Two Solid Steel Rivets	48" Precision Lathe Turned Hardwood	-	046385452003	6	26.9 lbs
9	45201	S400 Workcrew™	Limited 15 Year	15 Gauge #2 / 9.5" x 11.5"	Forward Turned Step & 11" Tab Socket	Two Solid Steel Rivets	30" Precision Lathe Turned Hardwood	Steel D	046385452010	6	25.6 lbs
10	49430 SV-LR80	S300 DuraLite™	Limited 5 Year	16 Gauge #2 / 9.5" x 11.5"	Forward Turned Step	Hardwood Reinforcing Rod & PermaGrip™	43" Durable Fiberglass	Cushion	031365120249	6	21.6
11	49431 SV-DR82	S300 DuraLite™	Limited 5 Year	16 Gauge #2 / 9.5" x 11.5"	Forward Turned Step	Hardwood Reinforcing Rod & PermaGrip™	26" Durable Fiberglass	Poly D	031365120263	6	19.2

SHOVELS - ROUND POINT / DIGGING

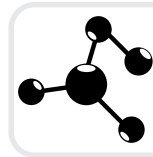

Unsurpassed superior heavy-duty polymer handles have a fiberglass core with polymer jacket.



#	SMW # LEGACY #	SERIES	WARRANTY	DESCRIPTION	HEAD STYLE	HEAD-TO-HANDLE	HANDLE TYPE	GRIP	UPC	PACK QTY	PACK WEIGHT
1	49131 SV-DR12	S300 DuraLite™	Limited 5 Year	16 Gauge #2 / 9.5" x 11.5"	Forward Turned Step	Solid Steel Rivet	26" Precision Lathe Turned Hardwood	Steel D	031365121208	6	21.6
2	49130 SV-LR10	S300 DuraLite™	Limited 5 Year	16 Gauge #2 / 9.5" x 11.5"	Forward Turned Step	Solid Steel Rivet	44" Precision Lathe Turned Hardwood	-	031365120133	6	22.8
3	49831 SV-DR92	S200™	Limited 1 Year	16 Gauge #2 / 8.6" x 10.5"	With Step	Solid Steel Rivet	26" Contoured Hardwood with Clear Lacquer Finish	Poly D	031365120270	6	19.2
4	49830 SV-LR90	S200™	Limited 1 Year	16 Gauge #2 / 8.6" x 10.5"	With Step	Solid Steel Rivet	42" Contoured Hardwood with Clear Lacquer Finish	-	031365120171	6	19.2
5	49650	S550 Irrigation™	Limited Lifetime	14 Gauge #2 / 9.5" x 11.5"	Forward Turned Step	Double Solid Steel Rivet	48" Polymer with Fiberglass Core	-	046385496502	6	37.2
6	49641	S550 Irrigation™	Limited Lifetime	16 Gauge #2 / 9.5" x 11.5"	Forward Turned Step	Solid Steel Rivet	28" Polymer with Fiberglass Core	Poly D	046385496410	3	12.6
7	49640	S550 Irrigation™	Limited Lifetime	16 Gauge #2 / 9.5" x 11.5"	Forward Turned Step	Solid Steel Rivet	48" Polymer with Fiberglass Core	-	046385496403	6	33.6

"RELEASING" PERFORATED BLADE ENGINEERED FOR WORKING WITH SATURATED MATERIALS & SIFTING

- Breaks Suction When Working in Wet Soils
- Allows Excess Water to Drain Through Perforations
- Has Less Surface Area Decreasing the Tendency for Wet Soil to Adhere to the Blade
- Blade Design is Lightweight, Ergonomic & Will Cause Less Fatigue
- Superior Tool for Digging in Mud, Muck, Clay & Water Saturated Materials
- Superior Tool for Sifting Debris from Sand, Gravel & Grain
- Polymer, Fiberglass & Hardwood Handles

Toolite® S550

MUD & MUCK



#	SMW #	SERIES	WARRANTY	DESCRIPTION	HEAD STYLE	HEAD-TO-HANDLE	HANDLE TYPE	GRIP	UPC	PACK QTY	PACK WEIGHT
1	49538	S550 Mud & Muck™	Limited 5 Year	14 Gauge #2 / 9.5" x 11.5"	Forward Turned Step / "Perforated"	Power Collar & Solid Steel Rivet	Professional Grade Fiberglass	Poly D	046385495383	3	10.2
2	49500	S550 Mud & Muck™	Limited 5 Year	14 Gauge #2 / 9.5" x 11.5"	Forward Turned Step / "Perforated"	Power Collar & Solid Steel Rivet	48" Professional Grade Fiberglass	Cushion	046385495000	6	20.4
3	49501	S550 Mud & Muck™	Limited 5 Year	14 Gauge #2 / 9.5" x 11.5"	Forward Turned Step / "Perforated"	Power Collar & Solid Steel Rivet	29" Professional Grade Fiberglass	Poly D	046385495017	3	10.8
4	49540	S550 Mud & Muck™	Limited 5 Year	14 Gauge #2 / 9.5" x 11.5"	Forward Turned Step / "Perforated"	Solid Steel Rivet	48" Polymer with Fiberglass Core	-	046385495406	6	30
5	49541	S550 Mud & Muck™	Limited 5 Year	14 Gauge #2 / 9.5" x 11.5"	Forward Turned Step / "Perforated"	Solid Steel Rivet	29" Polymer with Fiberglass Core	Poly D	046385495413	3	10.8
6	49490	S550 Mud & Muck™	Limited 5 Year	14 Gauge #2 / 9.5" x 11.5"	Forward Turned Step / "Perforated"	Solid Steel Rivet	48" Precision Lathe Turned Hardwood	-	046385494904	6	19.2
7	49491	S550 Mud & Muck™	Limited 5 Year	14 Gauge #2 / 9.5" x 11.5"	Forward Turned Step / "Perforated"	Solid Steel Rivet	29" Precision Lathe Turned Hardwood	Poly D	046385494911	3	9.6

SHOVELS - SQUARE POINT / TRANSFER



#	SMW # LEGACY #	SERIES	WARRANTY	DESCRIPTION	HEAD STYLE	HEAD-TO-HANDLE	HANDLE TYPE	GRIP	UPC	PACK QTY	PACK WEIGHT
1	49772 STR-S801	S800 SuperDuty™	Limited Lifetime	Forged #2 / 9.5" x 11.5"	Forward Turned Step	PowerCore™ & PermaGrip™	48" Premium Fiberglass	ProGrip™	036723008016	4	25.6
2	49742 STR-S701D	S700 SpringFlex™	Limited Lifetime	14 Gauge #2 Spring Steel / 9.5" x 11.5"	Rear Rolled Step	PowerCore™ & PermaGrip™	29" Premium Fiberglass	Poly D	036723017018	4	18.4
3	49732 STR-S701	S700 SpringFlex™	Limited Lifetime	14 Gauge #2 Spring Steel / 9.5" x 11.5"	Rear Rolled Step	PowerCore™ & PermaGrip™	48" Premium Fiberglass	ProGrip™	036723007019	4	21.6
4	49563 STR-S601D	S600 Power™	Limited Lifetime	14 Gauge #2 / 9.5" x 11.5"	Forward Turned Step	PowerCore™ & PermaGrip™	29" Premium Fiberglass	Poly D	036723016011	4	19.2
5	49562 STR-S601	S600 Power™	Limited Lifetime	14 Gauge #2 / 9.5" x 11.5"	Forward Turned Step	PowerCore™ & PermaGrip™	48" Premium Fiberglass	ProGrip™	036723006012	4	22.4
6	49760	S600 Safety™	Limited Lifetime	14 Gauge #2 / 9.5" x 11.5"	Forward Turned Step	PowerCore™ & PermaGrip™	29" Premium Fiberglass with 3M® Retroreflective Tape	Poly D	046385497608	4	19.2
7	49751	S600 Safety™	Limited Lifetime	14 Gauge #2 / 9.5" x 11.5"	Forward Turned Step	PowerCore™ & PermaGrip™	48" Premium Fiberglass with 3M® Retroreflective Tape	ProGrip™	046385497516	4	22.4

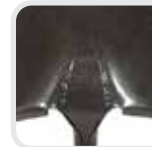

WHY CLOSED BACK?

Closed back shovels have welded backplates to prevent material build-up. These plates also provide extra strength.

#	SMW # LEGACY #	SERIES	WARRANTY	DESCRIPTION	HEAD STYLE	HEAD-TO-HANDLE	HANDLE TYPE	GRIP	UPC	PACK QTY	PACK WEIGHT
1	49173 SV-DS53	S550 Forged™	Limited Lifetime	Forged #2 / 9.5" x 11.5"	Forward Turned Step	Solid Steel Rivet	27" Precision Lathe Turned American Hardwood	Steel D	046385491736	4	24.8
2	49172 SV-LS51	S550 Forged™	Limited Lifetime	Forged #2 / 9.5" x 11.5"	Forward Turned Step	Solid Steel Rivet	48" Precision Lathe Turned American Hardwood	-	031365800011	4	26.4
3	45143	S500 Industrial™	Limited Lifetime	14 Gauge #2 / 9.5" x 11.5"	PowerSocket™ & Forward Turned Step	Fiberglass Insert & PermaGrip™	29" Industrial Grade Fiberglass	Poly D	046385451433	4	21.1
4	45142	S500 Industrial™	Limited Lifetime	14 Gauge #2 / 9.5" x 11.5"	PowerSocket™ & Forward Turned Step	Fiberglass Insert & PermaGrip™	48" Industrial Grade Fiberglass	ProGrip™	046385451426	4	21.9
5	45122	S500 Industrial™	Limited Lifetime	14 Gauge #2 / 9.5" x 11.5"	Rear Rolled Step	Fiberglass Insert & PermaGrip™	48" Industrial Grade Fiberglass	ProGrip™	046385451228	4	19.8
5	45132	S500 Industrial™	Limited Lifetime	14 Gauge #2 / 9.5" x 11.5"	Rear Rolled Step / Closed Back	Fiberglass Insert & PermaGrip™	48" Industrial Grade Fiberglass	ProGrip™	046385451327	4	20.5

SHOVELS - SQUARE POINT / TRANSFER



WHY CLOSED BACK?

Closed back shovels have welded backplates to prevent material build-up. These plates also provide extra strength.



#	SMW # LEGACY #	SERIES	WARRANTY	DESCRIPTION	HEAD STYLE	HEAD-TO- HANDLE	HANDLE TYPE	GRIP	UPC	PACK QTY	PACK WEIGHT
1	49333 SV-DS33	S500 Industrial™	Limited Lifetime	14 Gauge #2 / 9.5" x 11.5"	Forward Turned Step	Extended 11" Tab Socket with Two Solid Steel Rivets	30" Precision Lathe Turned American Hardwood	Steel D	031365121024	6	30.0
1	49339	S500 Industrial™	Limited Lifetime	14 Gauge #2 / 9.5" x 11.5"	Forward Turned Step	Extended 11" Tab Socket with Two Solid Steel Rivets	39" Precision Lathe Turned American Hardwood	Steel D	046385493396	6	35.2
2	49332 SV-LS31	S500 Industrial™	Limited Lifetime	14 Gauge #2 / 9.5" x 11.5"	Forward Turned Step	Extended 11" Tab Socket with Two Solid Steel Rivets	48" Precision Lathe Turned American Hardwood	-	031365120041	6	32.4
3	49345 SV-LS31CB	S500 Industrial™	Limited Lifetime	14 Gauge #2 / 9.5" x 11.5"	Forward Turned Step with Closed Back	Extended 11" Tab Socket with Two Solid Steel Rivets	48" Precision Lathe Turned American Hardwood	-	031365120003	6	31.2
4	49342 SV-LS35	S500 Industrial™	Limited Lifetime	14 Gauge #2 / 9.5" x 11.5"	Rear Rolled Step	Extended 11" Tab Socket with Two Solid Steel Rivets	48" Precision Lathe Turned American Hardwood	-	031365121475	6	33.6
5	49462 SV-DS43	S400 Jobsite™	Limited 15 Year	16 Gauge #2 / 9.5" x 11.5"	Forward Turned Step	Fiberglass Insert & PermaGrip™	26" Professional Grade Fiberglass	Poly D	031365121055	6	22.2
6	49452 SV-LS41	S400 Jobsite™	Limited 15 Year	16 Gauge #2 / 9.5" x 11.5"	Forward Turned Step	Fiberglass Insert & PermaGrip™	46" Professional Grade Fiberglass	Cushion	031365120089	6	24
7	49162 SV-DS23	S400 Jobsite™	Limited 15 Year	16 Gauge #2 / 9.5" x 11.5"	Forward Turned Step	Power Collar & Solid Steel Rivet	30" Precision Lathe Turned Hardwood	Steel D	031365121031	6	26.4
8	49152 SV-LS21	S400 Jobsite™	Limited 15 Year	16 Gauge #2 / 9.5" x 11.5"	Forward Turned Step	Power Collar & Solid Steel Rivet	48" Precision Lathe Turned Hardwood	-	031365120065	6	21.6
9	49353 SV-DSMP	S400 Jobsite™	Limited 5 Year	MiniPro Shovel 6" x 8"	Forward Turned Step	Solid Steel Rivet	12" Precision Lathe Turned Hardwood	Poly D	031365121246	6	12

SQUARE POINT / TRANSFER - SHOVELS



#	SMW # LEGACY #	SERIES	WARRANTY	DESCRIPTION	HEAD STYLE	HEAD-TO-HANDLE	HANDLE TYPE	GRIP	UPC	PACK QTY	PACK WEIGHT
1	49921	S400 Safety™	Limited 15 Year	16 Gauge #2 / 9.5" x 11.5"	Forward Turned Step	Fiberglass Insert & PermaGrip™	48" Professional Grade Fiberglass	Cushion	046385499213	6	24.0
2	49433 SV-DS83	S300 DuraLite™	Limited 5 Year	16 Gauge #2 / 9.5" x 11.5"	Forward Turned Step	Hardwood Reinforcing Rod & PermaGrip™	26" Durable Fiberglass	Poly D	031365120256	6	22.8
3	49432 SV-LS81	S300 DuraLite™	Limited 5 Year	16 Gauge #2 / 9.5" x 11.5"	Forward Turned Step	Hardwood Reinforcing Rod & PermaGrip™	43" Durable Fiberglass	Cushion	031365120232	6	24
4	45202	S400 Workcrew™	Limited 15 Year	15 Gauge #2 / 9.5" x 11.5"	Forward Turned Step & 11" Tab Socket	Two Solid Steel Rivets	48" Precision Lathe Turned Hardwood	-	046385452027	6	30.0 lbs
5	45203	S400 Workcrew™	Limited 15 Year	15 Gauge #2 / 9.5" x 11.5"	Forward Turned Step & 11" Tab Socket	Two Solid Steel Rivets	30" Precision Lathe Turned Hardwood	Steel D	046385452034	6	27.7 lbs
6	49142 SV-DS13	S300 DuraLite™	Limited 5 Year	16 Gauge #2 / 9.5" x 11.5"	Forward Turned Step	Solid Steel Rivet	26" Precision Lathe Turned Hardwood	Steel D	031365121222	6	25.2
7	49132 SV-LS11	S300 DuraLite™	Limited 5 Year	16 Gauge #2 / 9.5" x 11.5"	Forward Turned Step	Solid Steel Rivet	44" Precision Lathe Turned Hardwood	-	031365120140	6	24
8	49833 SV-DS93	S200™	Limited 1 Year	16 Gauge #2 / 8.6" x 10.5"	With Step	Solid Steel Rivet	26" Contoured Hardwood with Clear Lacquer Finish	Poly D	031365120287	6	21.6
9	49832 SV-LS91	S200™	Limited 1 Year	16 Gauge #2 / 8.6" x 10.5"	With Step	Solid Steel Rivet	42" Contoured Hardwood with Clear Lacquer Finish	-	031365120188	6	20.4

SHOVELS - SQUARE POINT / TRANSFER

Unsurpassed superior heavy-duty polymer handles have a fiberglass core with polymer jacket.

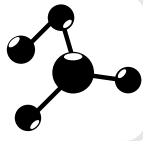

KENYON S550 IRRIGATION

#	SMW #	SERIES	WARRANTY	DESCRIPTION	HEAD STYLE	HEAD-TO-HANDLE	HANDLE TYPE	GRIP	UPC	PACK QTY	PACK WEIGHT
1	49662	S550 Irrigation™	Limited Lifetime	14 Gauge #2 / 9.5" x 11.5"	Forward Turned Step	Double Solid Steel Rivet	28" Polymer Jacket with Fiberglass Core	Poly D	046385496625	3	15.6
2	49652	S550 Irrigation™	Limited Lifetime	14 Gauge #2 / 9.5" x 11.5"	Forward Turned Step	Double Solid Steel Rivet	48" Polymer Jacket with Fiberglass Core	-	046385496526	3	13.2
3	49643	S550 Irrigation™	Limited Lifetime	16 Gauge #2 / 9.5" x 11.5"	Forward Turned Step	Solid Steel Rivet	28" Polymer Jacket with Fiberglass Core	Poly D	046385496434	6	38.4
4	49642	S550 Irrigation™	Limited Lifetime	16 Gauge #2 / 9.5" x 11.5"	Forward Turned Step	Solid Steel Rivet	48" Polymer Jacket with Fiberglass Core	-	046385496427	6	34.8

"RELEASING" PERFORATED BLADE ENGINEERED FOR WORKING WITH SATURATED MATERIALS & SIFTING

- Breaks Suction When Working in Wet Soils
- Allows Excess Water to Drain Through Perforations
- Has Less Surface Area Decreasing the Tendency for Wet Soil to Adhere to the Blade
- Blade Design is Lightweight, Ergonomic & Will Cause Less Fatigue
- Superior Tool for Digging in Mud, Muck, Clay & Water Saturated Materials
- Superior Tool for Sifting Debris from Sand, Gravel & Grain
- Polymer, Fiberglass & Hardwood Handles

Toolite® S550

MUD & MUCK



#	SMW #	SERIES	WARRANTY	DESCRIPTION	HEAD STYLE	HEAD-TO-HANDLE	HANDLE TYPE	GRIP	UPC	PACK QTY	PACK WEIGHT
1	49539	S550 Mud & Muck™	Limited 5 Year	14 Gauge #2 / 9.5" x 11.5"	Forward Turned Step "Perforated"	Power Collar & Solid Steel Rivet	Professional Grade Fiberglass	Poly D	046385495390	3	10.8
2	49502	S550 Mud & Muck™	Limited 5 Year	14 Gauge #2 / 9.5" x 11.5"	Forward Turned Step "Perforated"	Power Collar & Solid Steel Rivet	48" Professional Grade Fiberglass	Cushion	046385495024	6	20.4
3	49503	S550 Mud & Muck™	Limited 5 Year	14 Gauge #2 / 9.5" x 11.5"	Forward Turned Step "Perforated"	Power Collar & Solid Steel Rivet	29" Professional Grade Fiberglass	Poly D	046385495031	3	10.8
4	49542	S550 Mud & Muck™	Limited 5 Year	14 Gauge #2 / 9.5" x 11.5"	Forward Turned Step "Perforated"	Solid Steel Rivet	48" Polymer Jacket with Fiberglass Core	-	046385495420	6	28.8
5	49543	S550 Mud & Muck™	Limited 5 Year	14 Gauge #2 / 9.5" x 11.5"	Forward Turned Step "Perforated"	Solid Steel Rivet	29" Polymer Jacket with Fiberglass Core	Poly D	046385495437	3	12
6	49492	S550 Mud & Muck™	Limited 5 Year	14 Gauge #2 / 9.5" x 11.5"	Forward Turned Step "Perforated"	Solid Steel Rivet	48" Precision Lathe Turned Hardwood	-	046385494928	6	21.6
7	49493	S550 Mud & Muck™	Limited 5 Year	14 Gauge #2 / 9.5" x 11.5"	Forward Turned Step "Perforated"	Solid Steel Rivet	29" Precision Lathe Turned Hardwood	Poly D	046385494935	3	10.2

SHOVELS - DRAIN SPADES



#	SMW # LEGACY #	SERIES	WARRANTY	DESCRIPTION	HEAD STYLE	HEAD-TO-HANDLE	HANDLE TYPE	GRIP	UPC	PACK QTY	PACK WEIGHT
1	49777	S800 SuperDuty™	Limited Lifetime	10 Gauge	16" / Forward Turned Step	PowerCore™ & PermaGrip™	29" Premium Fiberglass	Poly D	046385497776	4	18
2	49589	S800 SuperDuty™	Limited Lifetime	10 Gauge	16" / Forward Turned Step	PowerCore™ & PermaGrip™	48" Premium Solid Fiberglass	ProGrip™	046385495895	4	32.8
2	49776	S800 SuperDuty™	Limited Lifetime	10 Gauge	16" / Forward Turned Step	PowerCore™ & PermaGrip™	48" Premium Fiberglass	ProGrip™	046385497769	4	26.4
3	49737 STR-S704D	S700 SpringFlex™	Limited Lifetime	14 Gauge Spring Steel	14" / Rear Rolled Step	PowerCore™ & PermaGrip™	29" Premium Fiberglass	Poly D	036723017049	4	18.4
4	49736 STR-S704	S700 SpringFlex™	Limited Lifetime	14 Gauge Spring Steel	14" / Rear Rolled Step	PowerCore™ & PermaGrip™	48" Premium Fiberglass	ProGrip™	036723007040	4	18.4
5	49557	S600 Power™	Limited Lifetime	14 Gauge	14" / Forward Turned Step	PowerCore™ & PermaGrip™	29" Premium Fiberglass	Poly D	046385495574	4	16
6	49556	S600 Power™	Limited Lifetime	14 Gauge	14" / Forward Turned Step	PowerCore™ & PermaGrip™	48" Premium Fiberglass	ProGrip™	046385495567	4	17.6



WHY CLOSED BACK?

Closed back shovels have welded backplates to prevent material build-up. These plates also provide extra strength.



#	SMW # LEGACY #	SERIES	WARRANTY	DESCRIPTION	HEAD STYLE	HEAD-TO-HANDLE	HANDLE TYPE	GRIP	UPC	PACK QTY	PACK WEIGHT
1	49567	S600 Power™	Limited Lifetime	14 Gauge	14" / Forward Turned Step with Closed Back	PowerCore™ & Solid Steel Rivet	29" Premium Fiberglass	Poly D	046385495673	3	14.4
2	49566	S600 Power™	Limited Lifetime	14 Gauge	14" / Forward Turned Step with Closed Back	PowerCore™ & Solid Steel Rivet	48" Premium Fiberglass	Cushion	046385495666	4	21.6
3	49559 STR-S604D	S600 Power™	Limited Lifetime	14 Gauge	16" / Forward Turned Step	PowerCore™ & PermaGrip™	29" Premium Fiberglass	Poly D	036723016042	4	17.6
4	49558 STR-S604	S600 Power™	Limited Lifetime	14 Gauge	16" / Forward Turned Step	PowerCore™ & PermaGrip™	48" Premium Fiberglass	ProGrip™	036723006043	4	20
5	49752	S600 Safety™	Limited Lifetime	14 Gauge	16" / Forward Turned Step	PowerCore™ & PermaGrip™	29" Premium Fiberglass	Poly D	046385497523	4	17.6
6	49758	S600 Safety™	Limited Lifetime	14 Gauge	16" / Forward Turned Step	PowerCore™ & PermaGrip™	48" Premium Fiberglass	ProGrip™	046385497585	4	20

SHOVELS - DRAIN SPADES



#	SMW # LEGACY #	SERIES	WARRANTY	DESCRIPTION	HEAD STYLE	HEAD-TO-HANDLE	HANDLE TYPE	GRIP	UPC	PACK QTY	PACK WEIGHT
1	49456 SV-LD40	S500 Industrial™	Limited Lifetime	14 Gauge	14" / Forward Turned Step	Fiberglass Insert & PermaGrip™	47" Industrial Grade Fiberglass	Cushion	031365123080	6	28.8
2	49457 SV-DD40	S500 Industrial™	Limited Lifetime	14 Gauge	14" / Forward Turned Step	Fiberglass Insert & PermaGrip™	26" Industrial Grade Fiberglass	Poly D	031365123400	6	28.8
3	49459 SV-DD46	S500 Industrial™	Limited Lifetime	14 Gauge	16" / Forward Turned Step	Fiberglass Insert & PermaGrip™	26" Industrial Grade Fiberglass	Poly D	031365123035	6	22.8
4	49459LO SV-DD46XL	S500 Industrial™	Limited Lifetime	14 Gauge	16" / Forward Turned Step	Fiberglass Insert & PermaGrip™	30" Industrial Grade Fiberglass	Poly D	031365123226	6	25.2
5	49346 SV-LD30	S500 Industrial™	Limited Lifetime	14 Gauge	16" / Forward Turned Step	Solid Steel Rivet	48" Precision Lathe Turned American Hardwood	-	031365123066	6	21.3
6	49138	S500 Industrial™	Limited Lifetime	14 Gauge	16" / Forward Turned Step	Solid Steel Rivet	30" Precision Lathe Turned American Hardwood	Steel D	046385491385	6	24



WHY CLOSED BACK?

Closed back shovels have welded backplates to prevent material build-up. These plates also provide extra strength.

#	SMW # LEGACY #	SERIES	WARRANTY	DESCRIPTION	HEAD STYLE	HEAD-TO-HANDLE	HANDLE TYPE	GRIP	UPC	PACK QTY	PACK WEIGHT
1	49157 SV-DD20	S500 Industrial™	Limited Lifetime	14 Gauge	14" / Forward Turned Step	Solid Steel Rivet	30" Precision Lathe Turned American Hardwood	Steel D	031365123011	6	22.8
2	49156 SV-LD20	S500 Industrial™	Limited Lifetime	14 Gauge	14" / Forward Turned Step	Solid Steel Rivet	48" Precision Lathe Turned American Hardwood	-	031365123059	6	25.2
3	49357	S500 Industrial™	Limited Lifetime	14 Gauge	14" / Forward Turned Step with Closed Back	Solid Steel Rivet	30" Precision Lathe Turned American Hardwood	Steel D	046385493570	4	19.2
4	49348 SV-DD30CB	S500 Industrial™	Limited Lifetime	14 Gauge	16" / Forward Turned Step with Closed Back	Solid Steel Rivet	30" Precision Lathe Turned American Hardwood	Steel D	031365121321	6	26.4
5	49437 SV-DD80	S300 DuraLite™	Limited 5 Year	16 Gauge	14" / Forward Turned Step	Hardwood Reinforcing Rod & PermaGrip™	26" Durable Fiberglass	Poly D	031365123042	6	20.4
6	49137 SV-DD10	S300 DuraLite™	Limited 5 Year	16 Gauge	14" / Forward Turned Step	Solid Steel Rivet	26" Precision Lathe Turned Hardwood	Steel D	031365123172	6	19.2

SHOVELS - DRAIN SPADES

Unsurpassed superior heavy-duty polymer handles have a fiberglass core with polymer jacket.

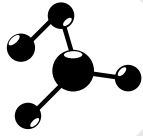

WHY CLOSED BACK?

Closed back shovels have welded backplates to prevent material build-up. These plates also provide extra strength.

#	SMW #	SERIES	WARRANTY	DESCRIPTION	HEAD STYLE	HEAD-TO-HANDLE	HANDLE TYPE	GRIP	UPC	PACK QTY	PACK WEIGHT
1	49669	S550 Irrigation™	Limited Lifetime	14 Gauge Sharpshooter	14" / Forward Turned Step with Closed Back	PermaGrip™ With Fiberglass Insert & Hardwood Plug	28" Professional Grade Fiberglass	Poly D	046385496694	3	12.0
2	49597	S550 Irrigation™	Limited Lifetime	14 Gauge Sharpshooter	14" / Forward Turned Step with Closed Back	Hardwood Insert & Solid Steel Rivet	48" Industrial Grade Fiberglass	Cushion	046385495970	6	21.6
3	49667	S550 Irrigation™	Limited Lifetime	14 Gauge Sharpshooter	14" / Forward Turned Step with Closed Back	Solid Steel Rivet	28" Polymer with Fiberglass Core	Poly D	046385496670	3	12.6
4	49666	S550 Irrigation™	Limited Lifetime	14 Gauge Sharpshooter	14" / Forward Turned Step with Closed Back	Solid Steel Rivet	48" Polymer with Fiberglass Core	-	046385496663	6	33.6
5	49337	S550 Irrigation™	Limited Lifetime	14 Gauge Sharpshooter	14" / Forward Turned Step with Closed Back	Solid Steel Rivet	27" Precision Lathe Turned Handle	-	046385493365	4	15.2
6	49336	S550 Irrigation™	Limited Lifetime	14 Gauge Sharpshooter	14" / Forward Turned Step with Closed Back	Solid Steel Rivet	48" Precision Lathe Turned Handle	Steel D	046385493372	4	18.0
7	49657	S550 Irrigation™	Limited Lifetime	14 Gauge	14" / Forward Turned Step	Power Collar & Solid Steel Rivet	28" Polymer with Fiberglass Core	Poly D	046385496571	4	16
8	49656	S550 Irrigation™	Limited Lifetime	14 Gauge	14" / Forward Turned Step	Power Collar & Solid Steel Rivet	48" Polymer with Fiberglass Core	-	046385496564	6	33.0

"RELEASING" PERFORATED BLADE ENGINEERED FOR WORKING WITH SATURATED MATERIALS & SIFTING

- Breaks Suction When Working in Wet Soils
- Allows Excess Water to Drain Through Perforations
- Has Less Surface Area Decreasing the Tendency for Wet Soil to Adhere to the Blade
- Blade Design is Lightweight, Ergonomic & Will Cause Less Fatigue
- Superior Tool for Digging in Mud, Muck, Clay & Water Saturated Materials
- Superior Tool for Sifting Debris from Sand, Gravel & Grain
- Polymer, Fiberglass & Hardwood Handles

Toolite® S⁵⁵⁰

MUD & MUCK



#	SMW #	SERIES	WARRANTY	DESCRIPTION	HEAD STYLE	HEAD-TO-HANDLE	HANDLE TYPE	GRIP	UPC	PACK QTY	PACK WEIGHT
1	49507	S550 Mud & Muck™	Limited 5 Year	14 Gauge	14" / Forward Turned Step	Fiberglass Insert & Solid Steel Rivet	29" Professional Grade Fiberglass	Poly D	046385495079	3	13.2
2	49546	S550 Mud & Muck™	Limited 5 Year	14 Gauge	14" / Forward Turned Step	Solid Steel Rivet	48" Polymer with Fiberglass Core	-	046385495468	6	33.6
3	49547	S550 Mud & Muck™	Limited 5 Year	14 Gauge	14" / Forward Turned Step	Solid Steel Rivet	29" Polymer with Fiberglass Core	Poly D	046385495475	3	13.8
4	49497	S550 Mud & Muck™	Limited 5 Year	14 Gauge	14" / Forward Turned Step	Solid Steel Rivet	29" Precision Lathe Turned Hardwood	Poly D	046385494973	3	13.8

SHOVELS - GARDEN SPADES



Landscape and construction contractors who do heavy digging love our Kenyon all-steel products. They provide the best in rock-moving, root chopping and prying capabilities.

Constructed of ultra-thick, heavy-weight 9 gauge welded steel with a smooth powder coat, these tools are ready for extreme applications.



WHY CLOSED BACK?
Closed back shovels have welded backplates to prevent material build-up. These plates also provide extra strength.

#	SMW # LEGACY #	SERIES	WARRANTY	DESCRIPTION	HEAD STYLE	HEAD-TO-HANDLE	HANDLE TYPE	GRIP	UPC	PACK QTY	PACK WEIGHT
1	49774 STR-S805D	S800 SuperDuty™	Limited Lifetime	Forged / 7" x 12"	Forward Turned Step	PowerCore™ & PermaGrip™	29" Premium Fiberglass	Poly D	036723018053	4	24.0
2	49733 STR-S705	S700 SpringFlex™	Limited Lifetime	14 Gauge Spring Steel / 7.5" x 12"	Rear Rolled Step	PowerCore™ & PermaGrip™	48" Premium Fiberglass	ProGrip™	036723007057	4	19.2
3	49734 STR-S705D	S700 SpringFlex™	Limited Lifetime	14 Gauge Spring Steel / 7.5" x 12"	Rear Rolled Step	PowerCore™ & PermaGrip™	29" Premium Fiberglass	Poly D	036723017056	4	17.6
4	49553 STR-S605	S600 Power™	Limited Lifetime	14 Gauge / 7" x 12"	Forward Turned Step	PowerCore™ & PermaGrip™	48" Premium Fiberglass	ProGrip™	036723006050	4	19.2
5	49554 STR-S605D	S600 Power™	Limited Lifetime	14 Gauge / 7" x 12"	Forward Turned Step	PowerCore™ & PermaGrip™	29" Premium Fiberglass	Poly D	036723016059	4	17.6
6	49653	S550 Irrigation™	Limited Lifetime	14 Gauge / 7" x 12"	Forward Turned Step	Power Collar & Solid Steel Rivet	48" Polymer with Fiberglass Core	-	046385496533	6	33.6
7	49654	S550 Irrigation™	Limited Lifetime	14 Gauge / 7" x 12"	Forward Turned Step	Power Collar & Solid Steel Rivet	28" Polymer with Fiberglass Core	Poly D	046385496540	3	13.8
8	49957	S550 Irrigation™	Limited Lifetime	9 Gauge / 12"	"V" Shaped Head / Closed Back	All-Steel	27" Steel	Steel D	046385499572	3	24.0
9	49958	S550 Irrigation™	Limited Lifetime	9 Gauge / 15"	"V" Shaped Head / Closed Back	All-Steel	27" Steel	Steel D	046385499589	3	25.8



WHY CLOSED BACK?

Closed back shovels have welded backplates to prevent material build-up. These plates also provide extra strength.



#	SMW # LEGACY #	SERIES	WARRANTY	DESCRIPTION	HEAD STYLE	HEAD-TO-HANDLE	HANDLE TYPE	GRIP	UPC	PACK QTY	PACK WEIGHT
1	49174 SV-GD50	S550 Forged™	Limited Lifetime	Forged / 7" x 12"	Forward Turned Step	Solid Steel Rivet	30" Precision Lathe Turned American Hardwood	Steel D	031365800042	4	24
2	49334 SV-GD34	S500 Industrial™	Limited Lifetime	16 Gauge / 7" x 12"	Rear Turned Step	Power Collar & Solid Steel Rivet	30" Precision Lathe Turned American Hardwood	Steel D	031365122007	6	28.8
2	49335 SV-GD34CB	S500 Industrial™	Limited Lifetime	16 Gauge / 7" x 12"	Rear Rolled Step with Closed Back	Power Collar & Solid Steel Rivet	30" Precision Lathe Turned American Hardwood	Steel D	031365119991	6	24
3	49368	S500 Industrial™	Limited Lifetime	16 Gauge / 7" x 12"	Rear Rolled Step with Closed Back	Solid Steel Rivet	48" Precision Lathe Turned American Hardwood	-	046385493686	6	24.0
4	49453	S500 Industrial™	Limited Lifetime	16 Gauge / 7" x 12"	Rear Turned Step	Fiberglass Insert & PermaGrip™	48" Industrial Grade Fiberglass	Cushion	031365122137	6	21.6
5	49454 SV-GD44	S500 Industrial™	Limited Lifetime	16 Gauge / 7" x 12"	Rear Turned Step	Fiberglass Insert & PermaGrip™	27" Industrial Grade Fiberglass	Poly D	031365122052	6	25.8
6	49153 SV-GL24	S400 Jobsite™	Limited 15 Year	16 Gauge / 7" x 12"	Rear Turned Step	Solid Steel Rivet	48" Precision Lathe Turned Hardwood	-	031365122021	6	25.2
7	49154 SV-GD24	S400 Jobsite™	Limited 15 Year	16 Gauge / 7" x 12"	Rear Turned Step	Solid Steel Rivet	30" Precision Lathe Turned Hardwood	Steel D	031365122014	6	22.2
8	49134 SV-GD10	S300 DuraLite™	Limited 5 Year	16 Gauge / 6.6" x 11.5"	Rear Rolled Step	Solid Steel Rivet	26" Precision Lathe Turned Hardwood	Steel D	031365122045	6	19.2

SHOVELS - CLEAN OUT



CLEANOUT SHOVELS HAVE SIZE & COLOR CODED LABELS



#	SMW # LEGACY #	SERIES	WARRANTY	DESCRIPTION	HEAD STYLE	HEAD-TO-HANDLE	HANDLE TYPE	GRIP	UPC	PACK QTY	PACK WEIGHT
1	89184 STR-S703	S700 SpringFlex™	Limited Lifetime	14 Gauge Spring Steel	4" / Forward Turned Step	PowerCore™ & PermaGrip™	48" Premium Fiberglass	ProGrip™	036723007033	4	16.5
2	89185 STR-S702	S700 SpringFlex™	Limited Lifetime	14 Gauge Spring Steel	5" / Forward Turned Step	PowerCore™ & PermaGrip™	48" Premium Fiberglass	ProGrip™	036723007026	4	17.5
3	89084 SV-TR44	S550 Irrigation™	Limited Lifetime	14 Gauge	4" / Forward Turned Step	Fiberglass Insert & PermaGrip™	48" Professional Grade Fiberglass	Cushion	031365107158	6	24
4	89095	S550 Irrigation™	Limited Lifetime	14 Gauge	5" / Forward Turned Step	Fiberglass Insert & PermaGrip™	12" Professional Grade Fiberglass	Poly D	046385890959	3	15.75
5	89085 SV-TR45	S550 Irrigation™	Limited Lifetime	14 Gauge	5" / Forward Turned Step	Fiberglass Insert & PermaGrip™	48" Professional Grade Fiberglass	Cushion	031365107165	6	24
6	89194	S550 Irrigation™	Limited Lifetime	14 Gauge	4" / Forward Turned Step	Solid Steel Rivet	48" Polymer with Fiberglass Core	-	046385891949	6	30
7	89195	S550 Irrigation™	Limited Lifetime	14 Gauge	5" / Forward Turned Step	Solid Steel Rivet	48" Polymer with Fiberglass Core	-	046385891956	6	30
8	89044 SV-TR14	S550 Irrigation™	Limited Lifetime	14 Gauge	4" / Forward Turned Step	Solid Steel Rivet	48" Precision Lathe Turned American Hardwood	-	031365107097	6	19.2
9	89045 SV-TR15	S550 Irrigation™	Limited Lifetime	14 Gauge	5" / Forward Turned Step	Solid Steel Rivet	48" Precision Lathe Turned American Hardwood	-	031365107110	6	21.6

35° / 11 GAUGE TRENCHING - SHOVELS



We offer two different head angles / thicknesses for our trenching shovels. Our 28°, 14 gauge heads put the handle closer to the worker for greater productivity while the 35°, 11 gauge heads are ideal for both digging and cleaning out trenches.



TRENCHING SHOVELS HAVE SIZE & COLOR CODED LABELS

#	SMW #	SERIES	WARRANTY	DESCRIPTION	HEAD STYLE	HEAD-TO-HANDLE	HANDLE TYPE	GRIP	UPC	PACK QTY	PACK WEIGHT
1	89133	S550 Irrigation™	Limited Lifetime	11 Gauge General Purpose Trench Cleaning & Digging Shovel	35° 3" / Forward Turned Boot Saver™	Fiberglass Insert & Solid Steel Rivet	53" Extended Professional Grade Fiberglass	Cushion	046385891338	6	28.8
2	89134	S550 Irrigation™	Limited Lifetime	11 Gauge General Purpose Trench Cleaning & Digging Shovel	35° 4" / Forward Turned Boot Saver™	Fiberglass Insert & Solid Steel Rivet	53" Extended Professional Grade Fiberglass	Cushion	046385891345	6	32.4
3	89135	S550 Irrigation™	Limited Lifetime	11 Gauge General Purpose Trench Cleaning & Digging Shovel	35° 5" / Forward Turned Boot Saver™	Fiberglass Insert & Solid Steel Rivet	53" Extended Professional Grade Fiberglass	Cushion	046385891352	6	32.4
4	89136	S550 Irrigation™	Limited Lifetime	11 Gauge General Purpose Trench Cleaning & Digging Shovel	35° 6" / Forward Turned Boot Saver™	Fiberglass Insert & Solid Steel Rivet	53" Extended Professional Grade Fiberglass	Cushion	046385891369	6	34.8
5	89123	S550 Irrigation™	Limited Lifetime	11 Gauge General Purpose Trench Cleaning & Digging Shovel	35° 3" / Forward Turned Boot Saver™	Fiberglass Insert & Solid Steel Rivet	48" Professional Grade Fiberglass	Cushion	046385891239	6	19.8
6	89124	S550 Irrigation™	Limited Lifetime	11 Gauge General Purpose Trench Cleaning & Digging Shovel	35° 4" / Forward Turned Boot Saver™	Fiberglass Insert & Solid Steel Rivet	48" Professional Grade Fiberglass	Cushion	046385891246	6	28.8

SHOVELS - 35° / 11 GAUGE TRENCHING



TRENCHING SHOVELS HAVE SIZE & COLOR CODED LABELS



#	SMW #	SERIES	WARRANTY	DESCRIPTION	HEAD STYLE	HEAD-TO-HANDLE	HANDLE TYPE	GRIP	UPC	PACK QTY	PACK WEIGHT
1	89125	S550 Irrigation™	Limited Lifetime	11 Gauge General Purpose Trench Cleaning & Digging Shovel	35° 5" / Forward Turned Boot Saver™	Fiberglass Insert & Solid Steel Rivet	48" Professional Grade Fiberglass	Cushion	046385891253	6	31.2
2	89126	S550 Irrigation™	Limited Lifetime	11 Gauge General Purpose Trench Cleaning & Digging Shovel	35° 6" / Forward Turned Boot Saver™	Fiberglass Insert & Solid Steel Rivet	48" Professional Grade Fiberglass	Cushion	046385891260	6	31.2
3	89023	S550 Irrigation™	Limited Lifetime	11 Gauge General Purpose Trench Cleaning & Digging Shovel	35° 3" / Forward Turned Boot Saver™	Solid Steel Rivet	48" Precision Lathe Turned American Hardwood	-	046385890232	6	24.6
4	89024	S550 Irrigation™	Limited Lifetime	11 Gauge General Purpose Trench Cleaning & Digging Shovel	35° 4" / Forward Turned Boot Saver™	Solid Steel Rivet	48" Precision Lathe Turned American Hardwood	-	046385890249	6	28.8
5	89025	S550 Irrigation™	Limited Lifetime	11 Gauge General Purpose Trench Cleaning & Digging Shovel	35° 5" / Forward Turned Boot Saver™	Solid Steel Rivet	48" Precision Lathe Turned American Hardwood	-	046385890256	6	31.38
6	89026	S550 Irrigation™	Limited Lifetime	11 Gauge General Purpose Trench Cleaning & Digging Shovel	35° 6" / Forward Turned Boot Saver™	Solid Steel Rivet	48" Precision Lathe Turned American Hardwood	-	046385890263	6	32.4

28° angle

35° angle

We offer two different head angles / thicknesses for our trenching shovels. Our 28°, 14 gauge heads put the handle closer to the worker for greater productivity while the 35°, 11 gauge heads are ideal for both digging and cleaning out trenches.



TRENCHING SHOVELS HAVE SIZE & COLOR CODED LABELS



#	SMW # LEGACY #	SERIES	WARRANTY	DESCRIPTION	HEAD STYLE	HEAD-TO-HANDLE	HANDLE TYPE	GRIP	UPC	PACK QTY	PACK WEIGHT
1	89273 STR-S708	S600 Power™	Limited Lifetime	14 Gauge Trench Digging Shovel	28° 3" / Forward Turned Boot Saver™	Fiberglass Core & Solid Steel Rivet	53" Premium Fiberglass	ProGrip™	036723007088	4	15
2	89274 STR-S709	S600 Power™	Limited Lifetime	14 Gauge Trench Digging Shovel	28° 4" / Forward Turned Boot Saver™	Fiberglass Core & Solid Steel Rivet	53" Premium Fiberglass	ProGrip™	036723007095	4	16
3	89275 STR-S717	S600 Power™	Limited Lifetime	14 Gauge Trench Digging Shovel	28° 5" / Forward Turned Boot Saver™	Fiberglass Core & Solid Steel Rivet	53" Premium Fiberglass	ProGrip™	036723007170	4	17
4	89243	S550 Irrigation™	Limited Lifetime	14 Gauge Trench Digging Shovel	28° 3" / Forward Turned Boot Saver™	Solid Steel Rivet	48" Polymer with Fiberglass Core	-	046385892434	6	28.8
5	89244	S550 Irrigation™	Limited Lifetime	14 Gauge Trench Digging Shovel	28° 4" / Forward Turned Boot Saver™	Solid Steel Rivet	48" Polymer with Fiberglass Core	-	046385892441	6	28.8
6	89245	S550 Irrigation™	Limited Lifetime	14 Gauge Trench Digging Shovel	28° 5" / Forward Turned Boot Saver™	Solid Steel Rivet	48" Polymer with Fiberglass Core	-	046385892458	6	31.8
7	89246	S550 Irrigation™	Limited Lifetime	14 Gauge Trench Digging Shovel	28° 6" / Forward Turned Boot Saver™	Solid Steel Rivet	48" Polymer with Fiberglass Core	-	046385892465	6	34.8

SHOVELS - 28° / 14 GAUGE TRENCHING



We offer two different head angles / thicknesses for our trenching shovels. Our 28°, 14 gauge heads put the handle closer to the worker for greater productivity while the 35°, 11 gauge heads are ideal for both digging and cleaning out trenches.



TRENCHING SHOVELS HAVE SIZE & COLOR CODED LABELS



#	SMW # LEGACY #	SERIES	WARRANTY	DESCRIPTION	HEAD STYLE	HEAD-TO-HANDLE	HANDLE TYPE	GRIP	UPC	PACK QTY	PACK WEIGHT
1	89233 SV-TR403	S550 Irrigation™	Limited Lifetime	14 Gauge Trench Digging Shovel	28° 3" / Blade Forward Turned Boot Saver™	Fiberglass Insert & Solid Steel Rivet	48" Professional Grade Fiberglass	Cushion	046385892335	6	19.2
2	89234 SV-TR404	S550 Irrigation™	Limited Lifetime	14 Gauge Trench Digging Shovel	28° 4" / Blade Forward Turned Boot Saver™	Fiberglass Insert & Solid Steel Rivet	48" Professional Grade Fiberglass	Cushion	046385892342	6	25.8
3	89235 SV-TR405	S550 Irrigation™	Limited Lifetime	14 Gauge Trench Digging Shovel	28° 5" / Blade Forward Turned Boot Saver™	Fiberglass Insert & Solid Steel Rivet	48" Professional Grade Fiberglass	Cushion	046385892359	6	27
4	89236	S550 Irrigation™	Limited Lifetime	14 Gauge Trench Digging Shovel	28° 6" / Blade Forward Turned Boot Saver™	Fiberglass Insert & Solid Steel Rivet	48" Professional Grade Fiberglass	Cushion	046385892366	6	28.8
5	89223 SV-TR23	S550 Irrigation™	Limited Lifetime	14 Gauge Trench Digging Shovel	28° 3" / Blade Forward Turned Boot Saver™	Solid Steel Rivet	48" Precision Lathe Turned American Hardwood	-	046385892236	6	18.6
6	89224 SV-TR24	S550 Irrigation™	Limited Lifetime	14 Gauge Trench Digging Shovel	28° 4" / Blade Forward Turned Boot Saver™	Solid Steel Rivet	48" Precision Lathe Turned Hardwood	-	046385892243	6	21
7	89225 SV-TR25	S550 Irrigation™	Limited Lifetime	14 Gauge Trench Digging Shovel	28° 5" / Blade Forward Turned Boot Saver™	Solid Steel Rivet	48" Precision Lathe Turned Hardwood	-	046385892250	6	23.32
8	89226	S550 Irrigation™	Limited Lifetime	14 Gauge Trench Digging Shovel	28° 6" / Blade Forward Turned Boot Saver™	Solid Steel Rivet	48" Precision Lathe Turned American Hardwood	-	046385892267	6	25.2



Caprock irrigation shovels feature 10 gauge or forged heads and low lift for near vertical digging. The super-duty heads provide exceptional strength.

#	SMW # LEGACY #	SERIES	WARRANTY	HEAD STYLE	HEAD-TO-HANDLE	HANDLE TYPE	GRIP	UPC	PACK QTY	PACK WEIGHT
1	49588	S800 SuperDuty™	Limited Lifetime	10 Gauge	PowerCore™ & PermaGrip™	50" Premium Solid Fiberglass Full Length Handle	ProGrip™	046385495888	4	39
1	49761	S800 SuperDuty™	Limited Lifetime	10 Gauge	PowerCore™ & PermaGrip™	48" Premium Fiberglass	ProGrip™	046385497615	4	32.6
2	49181 SV-CR50	S550 Forged™	Limited Lifetime	Forged	Solid Steel Rivet	46.5" Precision Lathe Turned American Hardwood	-	031365800028	4	37.2
3	49961	S550 Irrigation™	Limited Lifetime	Forged	Welded	48" All-Steel	Cushion	046385499619	1	9.4
4	49691	S550 Irrigation™	Limited Lifetime	Forged	Solid Steel Rivet	48" Polymer with Fiberglass Core	-	046385496915	6	27.2
5	49692	S550 Irrigation™	Limited Lifetime	Forged	Power Collar & Solid Steel Rivet	29" Polymer with Fiberglass Core	Poly D	046385496922	3	15

SHOVELS - IRRIGATION



WHY CLOSED BACK?

Closed back shovels have welded backplates to prevent material build-up. These plates also provide extra strength.



#	SMW # LEGACY #	SERIES	WARRANTY	DESCRIPTION	HEAD STYLE	HEAD-TO-HANDLE	HANDLE TYPE	GRIP	UPC	PACK QTY	PACK WEIGHT
1	49585	S800 SuperDuty™	Limited Lifetime	10 Gauge #00 / 7.5" x 9.5"	Closed Back	PowerCore™ & PermaGrip™	48" Premium Solid Fiberglass	ProGrip™	046385495857	4	22.8
2	49735 STR-S706	S700 SpringFlex™	Limited Lifetime	14 Gauge Spring Steel	Forward Turned Step	PowerCore™ & PermaGrip™	48" Premium Fiberglass	ProGrip™	036723007064	4	16.8
3	49180 SV-IR50	S550 Forged™	Limited Lifetime	Forged #00 / 7.5" x 9.5"	No Step	Solid Steel Rivet	48" Precision Lathe Turned American Hardwood	-	031365800035	4	20.8
4	49175	S550 Forged™	Limited Lifetime	Forged #2 / 9" x 12"	Tab Socket	Two Solid Steel Rivets	48" Precision Lathe Turned American Hardwood	-	046385491750	4	25.6
5	49455	S400 Jobsite™	Limited 15 Year	16 Gauge	Forward Turned Step	Fiberglass Insert & PermaGrip™	48" Professional Grade Fiberglass	Cushion	046385494553	6	24.6

IRRIGATION, TRANSPLANT & RICE - SHOVELS

Rice shovels are used for rice farming and irrigation. The perforations allow draining and ease of suction break.



#	SMW # LEGACY #	SERIES	WARRANTY	DESCRIPTION	HEAD STYLE	HEAD-TO-HANDLE	HANDLE TYPE	GRIP	UPC	PACK QTY	PACK WEIGHT
1	49155	S400 Jobsite™	Limited 15 Year	Irrigation Shovel	16 Gauge / Forward Turned Step	Solid Steel Rivet	48" Precision Lathe Turned Hardwood	-	046385491552	6	28.8
2	45420 SV-LR25	S400 Jobsite™	Limited 15 Year	Transplant Shovel	16 Gauge #0 / Forward Turned Step	Solid Steel Rivet	44" Precision Lathe Turned Hardwood	-	031365121994	6	21
3	45411	S400 Jobsite™	Limited 15 Year	Transplant Shovel	16 Gauge #00 / Forward Turned Step	Solid Steel Rivet	48" Precision Lathe Turned Hardwood	-	046385454113	6	21.6
4	49748 STR-S713	S600 Power™	Limited Lifetime	Rice Shovel	14 Gauge #2 / Forward Turned Step	PowerCore™ & PermaGrip™	48" Premium Fiberglass	ProGrip™	036723007132	4	19.2
5	49185 SV-RS50	S550 Forged™	Limited Lifetime	Rice Shovel	Forged	Solid Steel Rivet	48" Precision Lathe Turned American Hardwood	-	031365800103	4	23.2
6	49465 SV-RS40	S400 Jobsite™	Limited 15 Year	Rice Shovel	16 Gauge Forward Turned Step	Fiberglass Insert & PermaGrip™	48" Professional Grade Fiberglass	Cushion	031365120010	6	21.6
7	49085 SV-RS20	S400 Jobsite™	Limited 15 Year	Rice Shovel	16 Gauge Forward Turned Step	Solid Steel Rivet	48" Precision Lathe Turned Hardwood	-	031365120027	6	21.6

Shingle removers & notched roofing spades have a heavy-duty fulcrum welded to the back of the blade for leverage.



ULTIMATE SHINGLE REMOVER

The 49749 is a professional quality tool that makes shingle and nail removal easier. It has an extra strong steel brace and carbon steel skid plate.



WHY CLOSED BACK?

Closed back shovels have welded backplates to prevent material build-up. These plates also provide extra strength.

SP16003 - Shingle Remover Blade Kit for 49749

#	SMW # LEGACY #	SERIES	WARRANTY	DESCRIPTION	HEAD STYLE	HEAD-TO-HANDLE	HANDLE TYPE	GRIP	UPC	PACK QTY	PACK WEIGHT
1	49782 STR-S819D	S800 SuperDuty™	Limited Lifetime	Post Spade	Forged 16" / Forward Turned Step	PowerCore™ & PermaGrip™	29" Premium Fiberglass	Poly D	036723018190	4	24.8
2	49178 SV-PD50	S550 Forged™	Limited Lifetime	Post Spade	Forged 16" / Forward Turned Step	Solid Steel Rivet	30" Precision Lathe Turned American Hardwood	Steel D	031365800066	4	24
3	49749 STR-SG1	S600 Power™	Limited Lifetime	Shingle Remover	9" Carbon Steel Skid Plate with Fulcrum	PowerCore™ and Solid Steel Rivet	36" Premium Fiberglass	Poly D	036723500015	2	11.6
4	49168 SG-2LH	S500 Industrial™	Limited Lifetime	Roofing Spade	Fulcrum Head	Solid Steel Rivet	48" Precision Lathe Turned American Hardwood	-	031365015330	6	34.8
5	49169 SG-2DH	S500 Industrial™	Limited Lifetime	Roofing Spade	Fulcrum Head	Solid Steel Rivet	29" Precision Lathe Turned American Hardwood	Steel D	031365015323	6	28.8
6	49368	S500 Industrial™	Limited Lifetime	Roofing Spade	Closed Back, No Fulcrum, No Notch	Solid Steel Rivet	48" Precision Lathe Turned American Hardwood	-	046385493686	6	24.0
7	49191 SV-DRCH	S500 Industrial™	Limited Lifetime	Ceremonial Shovel	Chrome Finish	Solid Steel Rivet	29" Precision Lathe Turned Hardwood	Steel D	031365121192	1	3.4

SCOOP SIZE CHART

HEAD STYLE	MATERIAL TYPE	HEAD SIZE
#2 Gen Purp	Steel	11" x 13.5"
#2 Coal	Steel	13.5" x 14.5"
#6	Steel	12" x 16.25"
#8	Polymer	14" x 17"
#8	Steel	14" x 17"
#10	Aluminum	14.5" x 18"
#10	Heavy Alum	14.5" x 18"
#10	Poly	13.5" x 17"
#12	ABS / Poly	14.25" x 19"
#12	Aluminum	14.5" x 19"
#12	Steel	15" x 19"
#14	Aluminum	15.5" x 20"



#	SMW # LEGACY #	SERIES	WARRANTY	DESCRIPTION	HEAD STYLE	HEAD-TO-HANDLE	HANDLE TYPE	GRIP	UPC	PACK QTY	PACK WEIGHT
1	49216 STR-GP14D	S600 Power™	Limited Lifetime	General Purpose Scoop	#2 Steel 11" x 13.5"	PowerCore™ & PermaGrip™	29" Premium Fiberglass	Poly D	036723013164	4	21.6
2	49217 STR-GP14	S600 Power™	Limited Lifetime	General Purpose Scoop	#2 Steel 11" x 13.5"	PowerCore™ & PermaGrip™	48" Premium Fiberglass	ProGrip™	036723003165	4	23.2
3	49257	S500 Industrial™	Limited Lifetime	Eastern Scoop	#2 Steel 11" x 16"	Solid Steel Rivet	29" Precision Lathe Turned Hardwood	Steel D	046385492573	4	22
4	49019 SV-SDS12	S400 Jobsite™	Limited 15 Year	Grain Scoop	#12 Steel 15" x 19"	Solid Steel Rivet	29" Precision Lathe Turned Hardwood	Steel D	046385490197	3	22.35
5	49249 SV-SLSC2-54	S400 Jobsite™	Limited 15 Year	Coal Scoop	#2 Steel 13.5" x 14.5"	Solid Steel Rivet	54" Precision Lathe Turned Hardwood	-	031365123783	6	31.2
6	49248 SV-SDSC2	S400 Jobsite™	Limited 15 Year	Coal Scoop	#2 Steel 13.5" x 14.5"	Solid Steel Rivet	29" Precision Lathe Turned Hardwood	Steel D	031365123684	6	33



WHY CLOSED BACK?

Closed back shovels have welded backplates to prevent material build-up. These plates also provide extra strength.



Asphalt scoops / shovels are perfect for transferring heavy, loose material. The blade construction features a flat blade designed for moving asphalt. Great tool for professionals to utilize for moving asphalt.

NEW PRODUCT - 49190

#	SMW # LEGACY #	SERIES	WARRANTY	DESCRIPTION	HEAD STYLE	HEAD-TO-HANDLE	HANDLE TYPE	GRIP	UPC	PACK QTY	PACK WEIGHT
1	49001	S500 Industrial™	Lifetime	Asphalt Shovel, Round Head	Steel 12.625" x 15.75"	Fiberglass Insert & PermaGrip™	29" Industrial Grade Fiberglass	Poly D	046385490012	3	15.1
2	49002	S500 Industrial™	Lifetime	Asphalt Shovel, Square Head	Steel 11.06" x 12.625"	Fiberglass Insert & PermaGrip™	29" Industrial Grade Fiberglass	Poly D	046385490029	3	12.6
3	49190	S500 Industrial™	Lifetime	Asphalt Shovel, Square Head with Closed Back	12 Gauge Steel 9.25" x 11.5" Closed Back	Solid Steel Rivet	29" Precision Lathe Turned Hardwood	Steel D	046385491903	4	25.6
4	49006	S400 Jobsite™	15 Year	Eastern Scoop	#6 Steel 12" x 16.25"	Solid Steel Rivet	29" Precision Lathe Turned Hardwood	Steel D	046385490067	3	19.8
5	49013 SV-SS10	S300 DuraLite™	5 Year	General Purpose Scoop	#2 Steel 11" x 13.5"	Solid Steel Rivet	26" Precision Lathe Turned Hardwood	Steel D	031365123509	6	21.6
6	49016 SV-SS10L	S300 DuraLite™	5 Year	Asphalt Scoop	#2 Steel 11" x 13.5"	Solid Steel Rivet	36" Precision Lathe Turned Hardwood	Steel D	031365123639	6	32.4
7	49017 SV-SS11	S300 DuraLite™	5 Year	Asphalt Scoop	#2 Steel 11" x 13.5"	Solid Steel Rivet	44" Precision Lathe Turned Hardwood	-	031365235110	6	30



5000 SERIES ALUMINUM

Our grain scoops use 5000 series aluminum for the most wear-resistant scoop heads in the industry.



SCOOP SIZE CHART

HEAD STYLE	MATERIAL TYPE	HEAD SIZE
#2 Gen Purp	Steel	11" x 13.5"
#2 Coal	Steel	13.5" x 14.5"
#6	Steel	12" x 16.25"
#8	Polymer	14" x 17"
#8	Steel	14" x 17"
#10	Aluminum	14.5" x 18"
#10	Heavy Alum	14.5" x 18"
#10	Poly	13.5" x 17"
#12	ABS / Poly	14.25" x 19"
#12	Aluminum	14.5" x 19"
#12	Steel	15" x 19"
#14	Aluminum	15.5" x 20"

#	SMW # LEGACY #	SERIES	WARRANTY	DESCRIPTION	HEAD STYLE	HEAD-TO-HANDLE	HANDLE TYPE	GRIP	UPC	PACK QTY	PACK WEIGHT
1	49240 SV-SDA10H	S500 Industrial™	Limited Lifetime	Western Pattern Grain Scoop	#10 Heavy Aluminum 14.5" x 18"	Double Solid Steel Rivet	29" Precision Lathe Turned American Hardwood	Steel D	031365123486	6	28.8
2	49241 SV-SDA10HM	S500 Industrial™	Limited Lifetime	Western Pattern Grain Scoop	#10 Heavy Aluminum 14.5" x 18"	Double Solid Steel Rivet	36" Precision Lathe Turned American Hardwood	Steel D	031365123516	6	28.8
3	49242 SV-SDA10HL	S500 Industrial™	Limited Lifetime	Western Pattern Grain Scoop	#10 Heavy Aluminum 14.5" x 18"	Double Solid Steel Rivet	40" Precision Lathe Turned American Hardwood	Steel D	031365123493	6	34.8
4	49062 SV-SDA10	S500 Industrial™	Limited Lifetime	Western Pattern Grain Scoop	#10 Aluminum 14.5" x 18"	Double Solid Steel Rivet	29" Precision Lathe Turned Hardwood	Steel D	031365123677	6	25.2
5	49061	S500 Industrial™	Limited Lifetime	Western Pattern Grain Scoop	#10 Aluminum 14.5" x 18"	Double Solid Steel Rivet	48" Precision Lathe Turned Hardwood	-	046385490616	3	12.6

SCOOPS - ALUMINUM

5000 SERIES ALUMINUM

Our grain scoops use 5000 series aluminum for the most wear-resistant scoop heads in the industry.

AI
5000 SERIES
ALUMINUM



NEW PRODUCT - 49264

#	SMW # LEGACY #	SERIES	WARRANTY	DESCRIPTION	HEAD STYLE	HEAD-TO-HANDLE	HANDLE TYPE	GRIP	UPC	PACK QTY	PACK WEIGHT
1	49069 STR-AS19D	S600 Power™	Limited Lifetime	Western Pattern Grain Scoop	#12 Aluminum 14.5" x 19"	Fiberglass Insert with Double Solid Steel Rivet	29" Premium Fiberglass	Poly D	036723016097	4	16
2	49068 STR-AS19	S600 Power™	Limited Lifetime	Western Pattern Grain Scoop	#12 Aluminum 14.5" x 19"	Fiberglass Insert with Double Solid Steel Rivet	51" Premium Fiberglass	ProGrip™	036723006098	4	15.2
3	49755	S600 Safety™	Limited Lifetime	Western Pattern Grain Scoop	#12 Aluminum 14.5" x 19"	Fiberglass Insert with Double Solid Steel Rivet	29" Premium Fiberglass with 3M® Retroreflective Tape	Poly D	046385497554	4	16
4	49264	S400 Jobsite™	Limited 15 Year	Western Pattern Grain Scoop	#12 Aluminum 14.5" x 19"	Double Solid Steel Rivet	29" Hardwood	Poly D	031356492645	6	22.2
5	49265 SV-SLA12	S500 Industrial™	Limited Lifetime	Western Pattern Grain Scoop	#12 Aluminum 14.5" x 19"	Double Solid Steel Rivet	29" Precision Lathe Turned Hardwood	Steel D	031365123523	6	22.2
6	49064 SV-SLA12	S500 Industrial™	Limited Lifetime	Western Pattern Grain Scoop	#12 Aluminum 14.5" x 19"	Double Solid Steel Rivet	48" Precision Lathe Turned Hardwood	-	046385490647	3	13.8
7	49268 SV-SDA14H	S500 Industrial™	Limited Lifetime	Western Pattern Grain Scoop	#14 Heavy Aluminum 15.5" x 20"	Double Solid Steel Rivet	29" Precision Lathe Turned Hardwood	Steel D	031365123615	6	28.8



SCOOP SIZE CHART		
HEAD STYLE	MATERIAL TYPE	HEAD SIZE
#2 Gen Purp	Steel	11" x 13.5"
#2 Coal	Steel	13.5" x 14.5"
#6	Steel	12" x 16.25"
#8	Polymer	14" x 17"
#8	Steel	14" x 17"
#10	Aluminum	14.5" x 18"
#10	Heavy Alum	14.5" x 18"
#10	Poly	13.5" x 17"
#12	ABS / Poly	14.25" x 19"
#12	Aluminum	14.5" x 19"
#12	Steel	15" x 19"
#14	Aluminum	15.5" x 20"

5000 SERIES ALUMINUM

Our grain scoops use 5000 series aluminum for the most wear-resistant scoop heads in the industry.



#	SMW # LEGACY #	SERIES	WARRANTY	DESCRIPTION	HEAD STYLE	HEAD-TO-HANDLE	HANDLE TYPE	GRIP	UPC	PACK QTY	PACK WEIGHT
1	49063	S500 Industrial™	Limited Lifetime	Eastern Scoop	#2 Aluminum 11" x 13.5"	Solid Steel Rivet	29" Precision Lathe Turned Hardwood	Steel D	031365490632	6	17.9
2	49267 SV-SDA14HM	S500 Industrial™	Limited Lifetime	Western Pattern Grain Scoop	#14 Heavy Aluminum 15.5" x 20"	Double Solid Steel Rivet	36" Precision Lathe Turned Hardwood	Steel D	031365123592	6	29.4
3	49269 SV-SDA14HL	S500 Industrial™	Limited Lifetime	Western Pattern Grain Scoop	#14 Heavy Aluminum 15.5" x 20"	Double Solid Steel Rivet	40" Precision Lathe Turned Hardwood	Steel D	031365123585	6	30.6
4	49270 SV-SDA14	S500 Industrial™	Limited Lifetime	Western Pattern Grain Scoop	#14 Aluminum 15.5" x 20"	Double Solid Steel Rivet	29" Precision Lathe Turned Hardwood	Steel D	031365123530	6	22.8
5	49066	S500 Industrial™	Limited Lifetime	Western Pattern Grain Scoop	#14 Aluminum 15.5" x 20"	Double Solid Steel Rivet	48" Precision Lathe Turned Hardwood	-	046385490661	3	13.8
6	49060	S500 Industrial™	Limited Lifetime	Eastern Scoop	#2 Aluminum 11" x 13.5"	Solid Steel Rivet	48" Precision Lathe Turned Hardwood	-	046385490609	3	21.6
7	49512	S550 Mud & Muck™	Limited 5 Year	Sifting Scoop	Aluminum 13" x 17" Perforated	Solid Steel Rivet	48" Precision Lathe Turned Hardwood	-	046385495123	6	3.6



#	SMW # LEGACY #	SERIES	WARRANTY	DESCRIPTION	HEAD STYLE	HEAD-TO- HANDLE	HANDLE TYPE	GRIP	UPC	PACK QTY	PACK WEIGHT
1	49253 STR-GS18D	S600 Power™	Limited Lifetime	Grain Scoop	#12 Poly 14.25" x 19"	PowerCore™ with Solid Steel Rivet	29" Premium Fiberglass	Poly D	036723150043	4	16
2	49251 STR-GS18	S600 Power™	Limited Lifetime	Grain Scoop	#12 Poly 14.25" x 19"	PowerCore™ with Solid Steel Rivet	51" Premium Fiberglass	ProGrip™	036723006104	4	15.2
3	49757	S600 Safety™	Limited Lifetime	Grain Scoop	#12 Poly 14.25" x 19"	PowerCore™ with Solid Steel Rivet	29" Premium Fiberglass with 3M® Retroreflective Tape	Poly D	046385497578	4	16.0
4	49010 SV-SDP12	S400 Jobsite™	Limited 15 Year	Grain Scoop	#12 Poly 14.25" x 19"	Hardwood Insert with Solid Steel Rivet	27" Professional Grade Fiberglass	Poly D	031365123547	6	21.6
5	49010LO SV-SDP12L	S400 Jobsite™	Limited 15 Year	Grain Scoop	#12 Poly 14.25" x 19"	Hardwood Insert with Solid Steel Rivet	36" Professional Grade Fiberglass	Poly D	031365123554	6	24.0
6	49910	S400 Jobsite™	Limited 15 Year	Eastern Scoop	#8 Poly 14" x 17"	One Piece Mold	27" Polymer	Poly D	046385499107	6	21.6

SCOOP SIZE CHART

HEAD STYLE	MATERIAL TYPE	HEAD SIZE
#2 Gen Purp	Steel	11" x 13.5"
#2 Coal	Steel	13.5" x 14.5"
#6	Steel	12" x 16.25"
#8	Polymer	14" x 17"
#8	Steel	14" x 17"
#10	Aluminum	14.5" x 18"
#10	Heavy Alum	14.5" x 18"
#10	Poly	13.5" x 17"
#12	ABS / Poly	14.25" x 19"
#12	Aluminum	14.5" x 19"
#12	Steel	15" x 19"
#14	Aluminum	15.5" x 20"



#	SMW # LEGACY #	SERIES	WARRANTY	DESCRIPTION	HEAD STYLE	HEAD-TO-HANDLE	HANDLE TYPE	GRIP	UPC	PACK QTY	PACK WEIGHT
1	49053 SV-SDP12W	S400 Jobsite™	Limited 15 Year	Western Pattern Grain Scoop	#12 Poly 14.25" x 19"	Solid Steel Rivet	29" Precision Lathe Turned Hardwood	Poly D	031365123578	6	24
2	49051	S400 Jobsite™	Limited 15 Year	Western Pattern Grain Scoop	#12 Poly 14.25" x 19"	Solid Steel Rivet	48" Precision Lathe Turned Hardwood	-	046385490517	3	13.8
3	49050 SV-SDP12WP	S300 DuraLite™	Limited 5 Year	Western Pattern Grain Scoop	#12 Poly 14.25" x 19"	Solid Steel Rivet	29" Precision Lathe Turned Hardwood	Poly D	031365123745	6	19.2
4	49510	S550 Mud & Muck™	Limited 5 Year	Sifting Scoop	#8 Poly 14" x 17"	One Piece Mold	27" Polymer	Poly D	046385495109	6	21.6

POST HOLE DIGGERS - HERCULES



HERCULES PATTERN

Provides maximum strength for the most demanding industrial and commercial jobs.

Seymour Midwest manufactures the most complete line of post hole diggers in the industry, consisting of more than 20 diggers, including models for fencing contractors, utility linemen, and others who require precision performance.



SP21089 - 48" replacement fiberglass handles for 21210, sold individually
 SP21088 - 48" replacement fiberglass handles for 49753, sold individually

#	SMW # LEGACY #	SERIES	WARRANTY	PATTERN	BLADE	HEAD-TO-HANDLE	HANDLE TYPE	GRIP	UPC	PACK QTY	PACK WEIGHT
1	21210 STR-PD48	S600 Power™	Limited Lifetime	Hercules Pattern	11 Gauge Hardened & Sharpened Blade / 6.5" Spread	Double Bolt	48" Premium Fiberglass	ProGrip™	036723001109	2	21.6
2	21219 STR-PD96	S600 Power™	Limited Lifetime	Hercules Pattern	11 Gauge Hardened & Sharpened Blade / 6.5" Spread	Double Bolt	96" Premium Fiberglass	ProGrip™	036723134784	2	28.4
3	49753	S600 Safety™	Limited Lifetime	Hercules Pattern	11 Gauge Hardened & Sharpened Blade / 6.5" Spread	Double Bolt	48" Premium Fiberglass with 3M® Retroreflective Tape	ProGrip™	046385497530	2	21.6
4	21211 DG-11FG	S500 Industrial™	Limited Lifetime	Hercules Pattern	11 Gauge Hardened & Sharpened Blade / 6.5" Spread	Double Bolt	48" Industrial Grade Fiberglass	Cushion	031365016016	2	19.6
5	21206 DG-116	S500 Industrial™	Limited Lifetime	Hercules Pattern	11 Gauge Hardened & Sharpened Blade / 6.5" Spread	Double Bolt	72" Precision Molded & Turned American Hardwood	-	031365010809	2	23.2
5	21208 DG-118	S500 Industrial™	Limited Lifetime	Hercules Pattern	11 Gauge Hardened & Sharpened Blade / 6.5" Spread	Double Bolt	96" Precision Molded & Turned American Hardwood	-	031365011004	2	26.4
6	21200 DG-11	S500 Industrial™	Limited Lifetime	Hercules Pattern	11 Gauge Hardened & Sharpened Blade / 6.5" Spread	Double Bolt	48" Precision Molded & Turned American Hardwood	-	031365010601	2	21

ATLAS - POST HOLE DIGGERS



ATLAS PATTERN

Best suited for homeowner use and other occasional use applications.

Seymour Midwest manufactures the most complete line of post hole diggers in the industry, consisting of more than 20 diggers, including models for fencing contractors, utility linemen, and others who require precision performance.



SA11006 - Atlas blade with rivets

#	SMW # LEGACY #	SERIES	WARRANTY	PATTERN	BLADE	HEAD-TO-HANDLE	HANDLE TYPE	GRIP	UPC	PACK QTY	PACK WEIGHT
1	21110 DG-100FG	S400 Jobsite™	Limited 15 Year	Atlas Pattern	15 Gauge Sharpened Blade / 6" Spread	Double Bolt	48" Professional Fiberglass	Cushion	031365016009	2	14.8
2	21100 DG-100	S400 Jobsite™	Limited 15 Year	Atlas Pattern	15 Gauge Sharpened Blade / 5" Spread	Double Bolt	48" Precision Molded & Turned American Hardwood	-	031365011103	2	15.2
3	21105 DG-10	S400 Jobsite™	Limited 15 Year	Atlas Pattern	15 Gauge Sharpened Blade / 5" Spread	Double Bolt	48" Premium Quality American Hardwood	-	031365010106	2	15.6
4	21106 DG-106	S400 Jobsite™	Limited 15 Year	Atlas Pattern	15 Gauge Sharpened Blade / 5" Spread	Double Bolt	72" Precision Molded & Turned American Hardwood	-	031365010304	2	19.2
4	21108 DG-108	S400 Jobsite™	Limited 15 Year	Atlas Pattern	15 Gauge Sharpened Blade / 5" Spread	Double Bolt	96" Precision Molded & Turned American Hardwood	-	031365010502	2	21.6
5	21075 DG-75	S300 DuraLite™	Limited 5 Year	Atlas Pattern	13 Gauge Blade / 5" Spread	Double Bolt	48" Premium Quality American Hardwood	-	031365012445	2	14.5
6	21060 DG-60	S300 DuraLite™	Limited 5 Year	Atlas Pattern	13 Gauge Blade / 5" Spread	Double Bolt	48" Precision Molded & Turned American Hardwood	-	031365011127	2	14.5
7	21025 DG-25	S300 DuraLite™	Limited 5 Year	Jr. Atlas Pattern	13 Gauge Blade / 5" Spread	Single Bolt	42" Precision Molded & Turned American Hardwood	-	031365012407	2	11.5

POST HOLE DIGGERS - PERFECTION, GIBBS, BUCKEYE, LONESTAR



PERFECTION PATTERN

Has a unique "clamshell" head for digging in sandy, loamy, loosely-packed soils.



GIBBS PATTERN

Combines a single blade with hinge action that acts like a bucket to bring loose soil to the surface. Also called a mud bucket.



BUCKEYE PATTERN

Features strong steel pipe handles welded to the square steel shanks and yoke. Super tough square-cut steel blades are ideal for digging in heavy, rocky soils.



LONESTAR PATTERN

Features strong tubular steel handles welded to the thick yokes for digging in the hardest soils.



SP16005 - Perfection Blade
 SA11003 - Gibbs Blade with Rivets
 SP21008 - Gibbs Short Lever Replacement Handle
 SP21006 - Replacement Handle for Gibbs Digger
 SA11001 - Lonestar Blade with Rivets

#	SMW # LEGACY #	SERIES	WARRANTY	PATTERN	BLADE	HEAD-TO-HANDLE	HANDLE TYPE	GRIP	UPC	PACK QTY	PACK WEIGHT
1	21245 DG-12FG	S500 Industrial™	Limited Lifetime	Perfection Pattern	13 Gauge Sharpened Blade / 7.25" Spread	Double Bolt	48" Industrial Grade Fiberglass	Cushion	031365016030	2	15.6
2	21246 DG-126	S500 Industrial™	Limited Lifetime	Perfection Pattern	13 Gauge Sharpened Blade / 7.25" Spread	Double Bolt	72" Precision Molded & Turned American Hardwood	-	031365011509	2	19.2
2	21248 DG-128	S500 Industrial™	Limited Lifetime	Perfection Pattern	13 Gauge Sharpened Blade / 7.25" Spread	Double Bolt	96" Precision Molded & Turned American Hardwood	-	031365011707	2	21.0
3	21244 DG-12	S500 Industrial™	Limited Lifetime	Perfection Pattern	13 Gauge Sharpened Blade / 7.25" Spread	Double Bolt	48" Precision Molded & Turned American Hardwood	-	031365011301	2	15.2
4	21264 DG-18	S500 Industrial™	Limited Lifetime	Gibbs Pattern	13 Gauge Sharpened Single Blade Hinge	Double Bolt	54" Precision Molded & Turned American Hardwood	-	031365012100	2	21.6
4	21266 DG-186	S500 Industrial™	Limited Lifetime	Gibbs Pattern	13 Gauge Sharpened Single Blade Hinge	Double Bolt	72" Precision Molded & Turned American Hardwood	-	031365012124	2	22.8
4	21268 DG-188	S500 Industrial™	Limited Lifetime	Gibbs Pattern	13 Gauge Sharpened Single Blade Hinge	Double Bolt	96" Precision Molded & Turned American Hardwood	-	031365012148	2	28.4
5	21230 DG-16	S500 Industrial™	Limited Lifetime	Buckeye Pattern	11 Gauge Sharpened Blade / 6.5" Spread	Riveted	48" Steel	-	031365012001	2	31.6
6	21220 DG-15	S500 Industrial™	Limited Lifetime	Lonestar Pattern	11 Gauge Hardened & Sharpened Blade / 6.5" Spread	Welded	48" Steel	-	031365011905	2	32

TREE FEEDING AUGERS

Bore a 2" diameter hole for applying plant food and water to roots.

IWAN AUGERS

Are designed for general purpose use in a variety of soils. Steel blades are riveted to tough pliable iron yoke. Has a steel shaft with a welded steel t-handle.

ADJUSTABLE IWAN AUGERS

Will bore holes of varying diameters.

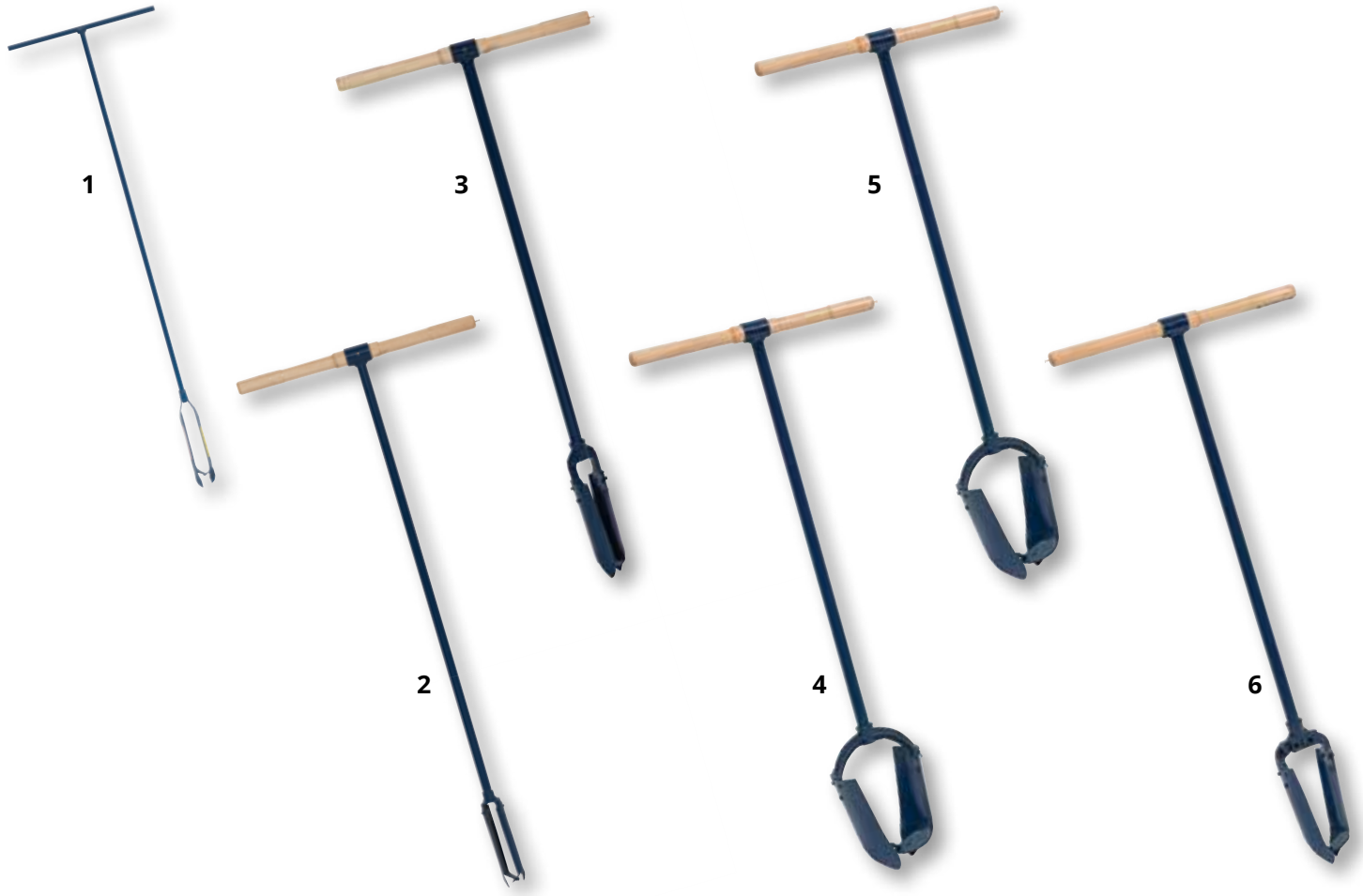

SA11023 - 2" Iwan Auger Head
 SA11024 - 3" Iwan Auger Head
 SA11025 - 4" Iwan Auger Head
 SA11026 - 6" Iwan Auger Head
 SA11022 - 8" Iwan auger head
 SA11020 - 10" Iwan auger head

SA11028 - 21324 Adjustable Auger Blade
 SA11029 - 21326 Adjustable Auger Blade
 SA22036 - Auger Wood Handle
 SP32071 - Auger Shaft 3/4" Pipe/Tee Weld/Thread
 Auger Extension SA22035 / SA22076

#	SMW # LEGACY #	SERIES	WARRANTY	DESCRIPTION	HEAD STYLE	HEAD-TO-HANDLE	HANDLE TYPE	UPC	PACK QTY	PACK WEIGHT
1	21332 AU-02T	S500 Industrial™	Limited Lifetime	Tree Feeding Auger	2" Point Spread	Steel Blades Welded to Shaft	Welded T-Handle	031365022000	6	10.2
2	21302 AU-S2	S500 Industrial™	Limited Lifetime	Iwan Auger	2" Point Spread	Steel Blades Riveted to Steel Yoke	Hardwood Replaceable	031365020105	2	9.2
3	21303 AU-S3	S500 Industrial™	Limited Lifetime	Iwan Auger	3" Point Spread	Steel Blades Riveted to Cast Yoke	Hardwood Replaceable	031365020303	2	12.8
4	21304 AU-S4	S500 Industrial™	Limited Lifetime	Iwan Auger	4" Point Spread	Steel Blades Riveted to Cast Yoke	Hardwood Replaceable	031365020402	2	13.4
4	21306 AU-S6	S500 Industrial™	Limited Lifetime	Iwan Auger	6" Point Spread	Steel Blades Riveted to Cast Yoke	Hardwood Replaceable	031365020600	2	14.8
4	21308 AU-S8	S500 Industrial™	Limited Lifetime	Iwan Auger	8" Point Spread	Steel Blades Riveted to Cast Yoke	Hardwood Replaceable	031365020808	2	18
5	21310 AU-S10	S500 Industrial™	Limited Lifetime	Iwan Auger	10" Point Spread	Steel Blades Riveted to Cast Yoke	Hardwood Replaceable	031365021003	2	22
6	21324 AU-A1	S500 Industrial™	Limited Lifetime	Adjustable Iwan Auger	4" / 5" / 6" Point Spread	Steel Blades Riveted to Cast Yoke	Hardwood Replaceable	031365021300	2	15.2
6	21326 AU-A2	S500 Industrial™	Limited Lifetime	Adjustable Iwan Auger	6" / 7" / 8" Point Spread	Steel Blades Riveted to Cast Yoke	Hardwood Replaceable	031365021409	2	17.2

RAKES - STEEL TINE LEAF RAKES

S600 & S500 SPRING BRACE RAKES:

- Oversized heavy-duty replaceable spring (SMW #40955)
- 1" powder-coated aluminum handles while our heavy-duty rakes have 15/16" hardwood handles
- Double through-bolted head-to-handle connection
- 24" head with 24 heavy-duty steel continuous tines or 18" head with 18 heavy-duty steel continuous tines



Our **SPRING BRACE LEAF RAKES** are built better to last longer. Intelligently-designed features include continuous tines from handle to tip and a durable spring brace that gives you the power to dig into thickly-matted leaves. Most of our rakes have single or double through-bolted heads that won't get loose or wobbly.



#	SMW # LEGACY #	SERIES	WARRANTY	DESCRIPTION	SPRING	HEAD-TO- HANDLE	HANDLE TYPE	GRIP	UPC	PACK QTY	PACK WEIGHT
1	40928 STR-SR22	S600 Power™	Limited Lifetime	24" / 24 Tine Spring Brace	Heavy-Duty Oversized Replaceable Spring	Double Bolt	54" Extra Reach Premium Fiberglass	ProGrip™	036723005220	4	11.2
2	40924	S500 Industrial™	Limited Lifetime	24" / 24 Tine Spring Brace	Industrial Grade Oversized Replaceable Spring	Double Bolt	54" ProGrade Extra Reach Powder-Coated Aluminum	Cushion	046385409243	12	28.8
3	40936	S500 Industrial™	Limited Lifetime	18" / 18 Tine Spring Brace	Industrial Grade Oversized Replaceable Spring	Double Bolt	54" ProGrade Extra Reach Powder-Coated Aluminum	Cushion	046385409366	12	34.8
4	40912	S500 Industrial™	Limited Lifetime	24" / 24 Tine Spring Brace	Industrial Grade Oversized Replaceable Spring	Double Bolt	54" Extra Reach Hardwood	-	046385409120	12	32.4
5	40932	S500 Industrial™	Limited Lifetime	18" / 18 Tine Spring Brace	Industrial Grade Oversized Replaceable Spring	Double Bolt	54" Extra Reach Hardwood	-	046385409328	12	16.8
6	40948 LF-40	S400 Jobsite™	Limited 15 Year	24" / 24 Tine Spring Brace	Contractor Grade Replaceable Spring	Single Bolt	54" Extra Reach Fiberglass	Cushion	031365128009	12	24
7	40945 LF-25	S400 Jobsite™	Limited 15 Year	24" / 24 Tine Spring Brace	Contractor Grade Replaceable Spring	Single Bolt	54" Extra Reach Wood	-	031365128030	12	31.2
8	40942 LF-22	S300 DuraLite™	Limited 5 Year	24" / 24 Tine Spring Brace	Durable Spring	Single Screw	48" Hardwood	-	031365128078	12	16.8
9	40940 LF-18	S300 DuraLite™	Limited 5 Year	18" / 18 Tine Spring Brace	Durable Spring	Single Screw	48" Hardwood	-	031365128047	12	16.8
10	43372 LF-22PS	S300 DuraLite™	Limited 5 Year	22" / 22 Tine Spring Brace	Durable Spring	Single Screw	48" Hardwood	-	031365128085	12	21.6



#	SMW #	SERIES	WARRANTY	DESCRIPTION	HEAD STYLE	HEAD-TO-HANDLE	HANDLE TYPE	GRIP	UPC	PACK QTY	PACK WEIGHT
1	43326	S400 Jobsite™	Limited 15 Year	24" Pro-Flex Leaf Rake	Zinc Plated Tines on Polymer Base	Single Bolt	48" Powder-Coated Aluminum	-	046385433262	12	16.8
2	43320	S400 Jobsite™	Limited 15 Year	18" Pro-Flex Leaf Rake	Zinc Plated Tines on Polymer Base	Single Bolt	48" Powder-Coated Aluminum	-	046385433200	12	14.4
3	43310	S400 Jobsite™	Limited 15 Year	8" Pro-Flex Shrub Rake	Zinc Plated Tines on Polymer Base	Single Bolt	48" Powder-Coated Aluminum	-	046385433101	12	9.6
4	43325	S400 Jobsite™	Limited 15 Year	24" Pro-Flex Leaf Rake	Zinc Plated Tines on Polymer Base	Single Bolt	48" Vinyl-Coated Steel	Hanging Tip	046385433255	12	16.8
5	43319	S400 Jobsite™	Limited 15 Year	18" Pro-Flex Leaf Rake	Zinc Plated Tines on Polymer Base	Single Bolt	48" Vinyl-Coated Steel	Hanging Tip	046385433194	12	14.4
6	43309	S400 Jobsite™	Limited 15 Year	8" Pro-Flex Shrub Rake	Zinc Plated Tines on Polymer Base	Single Bolt	48" Vinyl-Coated Steel	Hanging Tip	046385433095	12	12

RAKES - STEEL TINE PRO-FLEX



SP20163 - 48" x 15/16" Tapered Wood Handle for ProFlex Rake Head

#	SMW #	SERIES	WARRANTY	DESCRIPTION	HEAD STYLE	HEAD-TO-HANDLE	HANDLE TYPE	GRIP	UPC	PACK QTY	PACK WEIGHT
1	43324	S400 Jobsite™	Limited 15 Year	24" Pro-Flex Leaf Rake	Zinc Plated Tines on Polymer Base	Single Bolt	48" Hardwood	-	046385433248	12	19.2
2	43318	S400 Jobsite™	Limited 15 Year	18" Pro-Flex Leaf Rake	Zinc Plated Tines on Polymer Base	Single Bolt	48" Hardwood	-	046385433187	12	19.2
3	43308	S400 Jobsite™	Limited 15 Year	8" Pro-Flex Leaf Rake	Zinc Plated Tines on Polymer Base	Single Bolt	48" Hardwood	-	046385433088	12	14.4
4	43120	S300 DuraLite™	Limited 5 Year	18" Flexible Steel Leaf Rake	All-Steel Head on All-Steel Bracing Bar	Single Screw	48" Vinyl-Coated Steel	Hanging Tip	046385431206	12	20.4
5	43110	S300 DuraLite™	Limited 5 Year	7" Flexible Steel Shrub Rake	All-Steel Head on All-Steel Bracing Bar	Single Screw	48" Vinyl-Coated Steel	Hanging Tip	046385431107	12	12
6	43118	S300 DuraLite™	Limited 5 Year	18" Flexible Steel Leaf Rake	All-Steel Head on All-Steel Bracing Bar	Single Screw	48" Hardwood	-	046385431183	12	21.6
7	43108	S300 DuraLite™	Limited 5 Year	7" Flexible Steel Shrub Rake	All-Steel Head on All-Steel Bracing Bar	Single Screw	48" Hardwood	-	046385431084	12	14.4



Our **POLY LEAF RAKES** offer a single-piece head design for durability and longevity. The self-cleaning design is one of the best on the market. It typically only takes one easy back sweep to free the tines from leaves and debris.

#	SMW # LEGACY #	SERIES	WARRANTY	DESCRIPTION	HEAD-TO-HANDLE	HANDLE TYPE	GRIP	UPC	PACK QTY	PACK WEIGHT
1	40872 STR-PR24	S600 Power™	Limited Lifetime	24" Poly Leaf Rake	Single Steel Rivet	51" Premium Fiberglass	ProGrip™	036723005244	4	7.2
2	40885 LF-30PCG	S400 Jobsite™	Limited 15 Year	32" Poly Leaf Rake	Single Screw	48" Painted Wood	Cushion	031365128153	12	26.4
3	40884 LF-30P	S400 Jobsite™	Limited 15 Year	32" Poly Leaf Rake	Single Screw	48" Painted Wood	-	031365128092	16	32
4	40882 LF-20	S400 Jobsite™	Limited 15 Year	24" Poly Leaf Rake	Single Screw	48" Waxed Finish Wood	-	031365128016	12	14.4
5	40880 LF-8	S400 Jobsite™	Limited 15 Year	8" Poly Shrub Rake	Single Screw	42" Painted Wood	-	031365128108	12	6



SUPERIOR STRENGTH: WELDED AND RIVETED

Our Kenyon S550 Irrigation™ (42604 & 42600) are heavy-duty and long lasting tools. The head-to-handle connection features a unique tapered steel plug that is press fit into the powder-coated aluminum handle and then drilled and riveted all the way through. The bow rakes also feature a steel bow that is moved closer to the edge of the head, providing greater lateral stability, and is welded on both the front and back sides of the head for greater strength.



#	SMW # LEGACY #	SERIES	WARRANTY	DESCRIPTION	HEAD-TO-HANDLE	HANDLE TYPE	GRIP	UPC	PACK QTY	PACK WEIGHT
1	42366 STR-BR16	S800 SuperDuty™	Limited Lifetime	Forged 16" / 16 Tine	Nylon Adapter with Solid Steel Rivet	60" Premium Fiberglass	ProGrip™	036723005169	4	16
2	49754	S600 Safety™	Limited Lifetime	Forged 16" / 16 Tine	Nylon Adapter with Solid Steel Rivet	60" Premium Fiberglass with 3M® Retroreflective Tape	ProGrip™	046385497547	4	16
3	42604	S550 Irrigation™	Limited Lifetime	17" / 16 Tine Welded	Welded and Riveted Steel Plug	60" Powder Coated Aluminum	Cushion	046385426042	6	24.0
4	42600	S550 Irrigation™	Limited Lifetime	14" / 13 Tine Welded	Welded and Riveted Steel Plug	60" Powder Coated Aluminum	Cushion	046385426004	6	22.8
5	42357 BR-35	S550 Forged™	Limited Lifetime	Forged 16" / 16 Tine	Steel Ferrule with Solid Steel Rivet	60" Precision Lathe Turned American Hardwood	-	031365125039	6	24
6	42324 BR-40	S400 Jobsite™	Limited 15 Year	15" / 14 Tine Welded	Nylon Adapter with Solid Steel Rivet	60" Professional Grade Fiberglass	Cushion	031365125008	6	20.4



#	SMW # LEGACY #	SERIES	WARRANTY	DESCRIPTION	HEAD-TO-HANDLE	HANDLE TYPE	GRIP	UPC	PACK QTY	PACK WEIGHT
1	42355 BR-20	S400 Jobsite™	Limited 15 Year	15" / 14 Tine Welded	Steel Ferrule	54" Precision Lathe Turned Hardwood	-	031365125022	6	21.6
2	49924	S400 Safety™	Limited 15 Year	15" / 14 Tine Welded	Nylon Adapter with Solid Steel Rivet	60" Professional Grade Fiberglass with 3M® Retroreflective Tape	Cushion	046385499244	6	20.4
3	42364 BR-80	S300 DuraLite™	Limited 5 Year	14" / 14 Tine Welded	Nylon Adapter with Solid Steel Rivet	48" Durable Fiberglass	Cushion	031365125060	6	15.6
4	42320 BR-10	S300 DuraLite™	Limited 5 Year	14" / 14 Tine Welded	Steel Ferrule	54" Precision Lathe Turned Hardwood	-	031365125077	6	18
5	42016 BR-90	S200™	Limited 1 Year	14" / 14 Tine Welded	Steel Ferrule	48" Contoured Hardwood with Clear Lacquer Finish	-	031365125084	6	17.4

RAKES - STONE, LEVEL HEAD, ASPHALT & THATCHING

LEVEL HEAD RAKES have teeth designed to gather small weeds and straw. They are also ideal for raking small clods and for seedbed preparation while the flat side is used for leveling.



WHY THATCH?

Flanged teeth on both sides are designed for removing then collecting thatch and dead grass from lawns.

ASPHALT RAKE ADVANTAGES:

Heavy-duty construction, designed for tough use in asphalt paving. Long shank for extra reach to prevent asphalt build up.

#	SMW # LEGACY #	SERIES	WARRANTY	DESCRIPTION	HEAD STYLE	HEAD-TO-HANDLE	HANDLE TYPE	GRIP	UPC	PACK QTY	PACK WEIGHT
1	63124 SR-30	S550 Forged™	Limited Lifetime	Stone Rake	16" / 14 Tine Forged	Steel Ferrule	66" Precision Lathe Turned American Hardwood	-	031365125206	6	29.4
2	63126	S550 Forged™	Limited Lifetime	Stone Rake	18" / 16 Tine Forged	Steel Ferrule	66" Precision Lathe Turned American Hardwood	-	046385631262	3	15
3	42390 STR-LH16	S600 Power™	Limited Lifetime	Level Head Rake	16" / 16 Tine Tempered	Nylon Adapter with Solid Steel Rivet	64" Premium Fiberglass	ProGrip™	036723003172	4	14.4
4	42690	S550 Irrigation™	Limited Lifetime	Level Head Rake	17" / 16 Tine Tempered	Welded and Riveted Steel Plug	66" Powder-Coated Aluminum	Cushion	046385426905	6	21.6
5	42350 FR-21	S400 Jobsite™	Limited 15 Year	Level Head Rake	15" / 14 Tine	Steel Ferrule	60" Precision Lathe Turned Hardwood	-	031365125152	6	18
6	42351	S400 Jobsite™	Limited 15 Year	Level Head Rake	16" / 16 Tine	Steel Ferrule	66" Precision Lathe Turned Hardwood	-	046385423515	6	24
7	63128 AR-30	S550 Forged™	Limited Lifetime	Asphalt Rake	16" / 14 Tine Forged	Two Solid Steel Rivets	60" Precision Lathe Turned American Hardwood	-	046385631286	3	16.8
8	63130 TR-30	S400 Jobsite™	Limited 15 Year	Thatching Rake	15" Head with Thatching Teeth	Double Bolted	60" Precision Lathe Turned Hardwood	-	031365303093	2	8



FIELD / AGGREGATE RAKES

This head is designed with an excellent grading and striking edge and rounded, non-gouging teeth.



SA30001 - Braces, Wrap Around, Set of 2

#	SMW # LEGACY #	SERIES	WARRANTY	DESCRIPTION	HEAD STYLE	HEAD-TO-HANDLE	HANDLE TYPE	GRIP	UPC	PACK QTY	PACK WEIGHT
1	12024	S550 Professional™	Limited Lifetime	Field/Aggregate Rake	24" Heavy-Duty Aluminum	Wrap-Around Bracing	66" Powder-Coated Aluminum	Cushion	046385120247	12	50.4
1	12030	S550 Professional™	Limited Lifetime	Field/Aggregate Rake	30" Heavy-Duty Aluminum	Wrap-Around Bracing	66" Powder-Coated Aluminum	Cushion	046385120308	12	56
1	12036	S550 Professional™	Limited Lifetime	Field/Aggregate Rake	36" Heavy-Duty Aluminum	Wrap-Around Bracing	66" Powder-Coated Aluminum	Cushion	046385120360	12	63.6
1	12042	S550 Professional™	Limited Lifetime	Field/Aggregate Rake	42" Heavy-Duty Aluminum	Wrap-Around Bracing	66" Powder-Coated Aluminum	Cushion	046385120421	12	66
1	12048	S550 Professional™	Limited Lifetime	Field/Aggregate Rake	48" Heavy-Duty Aluminum	Wrap-Around Bracing	66" Powder-Coated Aluminum	Cushion	046385120483	12	72
1	12072	S550 Professional™	Limited Lifetime	Field/Aggregate Rake	72" Heavy-Duty Aluminum	Wrap-Around Bracing	66" Powder-Coated Aluminum	Cushion	046385120728	1	5.6
2	92324	S400 Jobsite™	Limited 15 Year	Field/Aggregate Rake - Point of Purchase	24" Aluminum	"Push-Pull" Bracing	66" Powder-Coated Aluminum	Cushion	046385923244	6	13.2
2	92024	S400 Jobsite™	Limited 15 Year	Field/Aggregate Rake	24" Aluminum	"Push-Pull" Bracing	66" Powder-Coated Aluminum	Cushion	046385920243	6	19.2
2	92330	S400 Jobsite™	Limited 15 Year	Field/Aggregate Rake - Point of Purchase	30" Aluminum	"Push-Pull" Bracing	66" Powder-Coated Aluminum	Cushion	046385923305	6	16.8
2	92030	S400 Jobsite™	Limited 15 Year	Field/Aggregate Rake	30" Aluminum	"Push-Pull" Bracing	66" Powder-Coated Aluminum	Cushion	046385920304	6	21.6
2	92336 LR-36A	S400 Jobsite™	Limited 15 Year	Field/Aggregate Rake - Point of Purchase	36" Aluminum	"Push-Pull" Bracing	66" Powder-Coated Aluminum	Cushion	046385923367	6	19.2
2	92036	S400 Jobsite™	Limited 15 Year	Field/Aggregate Rake	36" Aluminum	"Push-Pull" Bracing	66" Powder-Coated Aluminum	Cushion	046385920366	6	22.8
2	92342	S400 Jobsite™	Limited 15 Year	Field/Aggregate Rake - Point of Purchase	42" Aluminum	"Push-Pull" Bracing	66" Powder-Coated Aluminum	Cushion	046385923428	6	21.6
2	92042	S400 Jobsite™	Limited 15 Year	Field/Aggregate Rake	42" Aluminum	"Push-Pull" Bracing	66" Powder-Coated Aluminum	Cushion	046385920427	6	25.5
2	92348	S400 Jobsite™	Limited 15 Year	Field/Aggregate Rake - Point of Purchase	48" Aluminum	"Push-Pull" Bracing	66" Powder-Coated Aluminum	Cushion	046385923480	6	24
2	92048	S400 Jobsite™	Limited 15 Year	Field/Aggregate Rake	48" Aluminum	"Push-Pull" Bracing	66" Powder-Coated Aluminum	Cushion	046385920489	6	26.4

RAKES - FIELD & LANDSCAPE

LANDSCAPE RAKES

Have rounded teeth which provide a smooth non-gouging raking action, while its striking edge is excellent for grading. Strong wrap-around bracing and heavy-duty double rib construction maximizes head stability and ensures long-lasting performance, even under the heaviest professional use.



GREAT RAKE II

The name says it all... this is a "great rake" for raking and leveling. The long curved teeth provide more efficient grading on the backstroke, while the deep grading edge allows for superior leveling.

Replacement parts available for purchase.

#	SMW # LEGACY #	SERIES	WARRANTY	DESCRIPTION	HEAD STYLE	HEAD-TO-HANDLE	HANDLE TYPE	GRIP	UPC	PACK QTY	PACK WEIGHT
1	12100 STR-LR24	S600 Power™	Limited Lifetime	Field Rake	24" Heavy-Duty Aluminum	Wrap-Around Bracing	66" Premium Fiberglass	ProGrip™	036723500244	2	8.6
1	12101	S600 Power™	Limited Lifetime	Field Rake	30" Heavy-Duty Aluminum	Wrap-Around Bracing	66" Premium Fiberglass	ProGrip™	046385121015	2	9.4
1	12102 STR-LR36	S600 Power™	Limited Lifetime	Field Rake	36" Heavy-Duty Aluminum	Wrap-Around Bracing	66" Premium Fiberglass	ProGrip™	036723004360	2	10.1
1	12103	S600 Power™	Limited Lifetime	Field Rake	42" Heavy-Duty Aluminum	Wrap-Around Bracing	66" Premium Fiberglass	ProGrip™	046385121039	2	10.8
1	12104	S600 Power™	Limited Lifetime	Field Rake	48" Heavy-Duty Aluminum	Wrap-Around Bracing	66" Premium Fiberglass	ProGrip™	046385121046	2	11.5
2	14024	S550 Irrigation™	Limited Lifetime	Landscape Rake - Great Rake II	24" Heavy-Duty Aluminum	Wrap-Around Bracing	66" Powder-Coated Aluminum	Cushion	046385140245	1	3.6
2	14030	S550 Irrigation™	Limited Lifetime	Landscape Rake - Great Rake II	30" Heavy-Duty Aluminum	Wrap-Around Bracing	66" Powder-Coated Aluminum	Cushion	046385140306	1	4
2	14036	S550 Irrigation™	Limited Lifetime	Landscape Rake - Great Rake II	36" Heavy-Duty Aluminum	Wrap-Around Bracing	66" Powder-Coated Aluminum	Cushion	046385140368	1	4.2
2	14042	S550 Irrigation™	Limited Lifetime	Landscape Rake - Great Rake II	42" Heavy-Duty Aluminum	Wrap-Around Bracing	66" Powder-Coated Aluminum	Cushion	046385140429	1	5.1
2	14048	S550 Irrigation™	Limited Lifetime	Landscape Rake - Great Rake II	48" Heavy-Duty Aluminum	Wrap-Around Bracing	66" Powder-Coated Aluminum	Cushion	046385140481	1	5.5
3	10024	S550 Professional™	Limited Lifetime	Landscape Rake	24" Heavy-Duty Aluminum	Wrap-Around Bracing	66" Powder-Coated Aluminum	Cushion	046385100249	12	54
3	10030	S550 Professional™	Limited Lifetime	Landscape Rake	30" Heavy-Duty Aluminum	Wrap-Around Bracing	66" Powder-Coated Aluminum	Cushion	046385100300	12	57.6
3	10036	S550 Professional™	Limited Lifetime	Landscape Rake	36" Heavy-Duty Aluminum	Wrap-Around Bracing	66" Powder-Coated Aluminum	Cushion	046385100362	12	63.6
3	10042	S550 Professional™	Limited Lifetime	Landscape Rake	42" Heavy-Duty Aluminum	Wrap-Around Bracing	66" Powder-Coated Aluminum	Cushion	046385100423	12	64.8
3	10048	S550 Professional™	Limited Lifetime	Landscape Rake	48" Heavy-Duty Aluminum	Wrap-Around Bracing	66" Powder-Coated Aluminum	Cushion	046385100485	12	69.6



1



3



SCREENING RAKE DESIGN

This rake is specially designed for sifting, grading, and screening. It is an excellent tool when you need to sift or screen stones and debris from sand or fine soil.



2

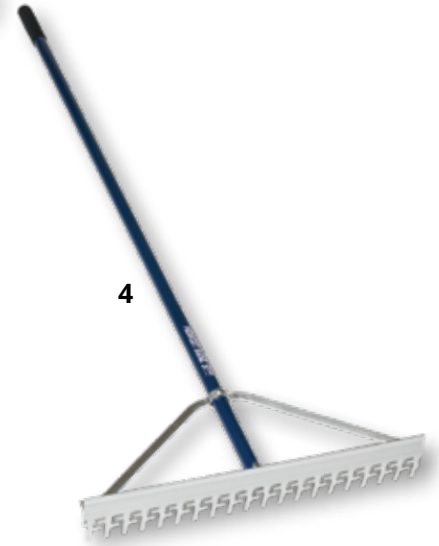

4

HOMEOWNER LANDSCAPING

Designed with the consumer in mind, the 90324 & 90330 landscape rake comes complete with a solid aluminum head, "push-pull" bracing to eliminate head wobble, and a 60" hardwood handle.

Replacement parts available for purchase.

#	SMW # LEGACY #	SERIES	WARRANTY	DESCRIPTION	HEAD STYLE	HEAD-TO-HANDLE	HANDLE TYPE	GRIP	UPC	PACK QTY	PACK WEIGHT
1	90324	S300 DuraLite™	Limited 5 Year	Landscape Rake	24" Aluminum	"Push-Pull" Bracing	60" Precision Lathe Turned Hardwood	-	046385903246	6	15.6
1	90330	S300 DuraLite™	Limited 5 Year	Landscape Rake	30" Aluminum	"Push-Pull" Bracing	60" Precision Lathe Turned Hardwood	-	046385903307	6	16.8
2	16114	S550 Professional™	Limited Lifetime	Mini Landscape Rake	14" Heavy-Duty Aluminum	"Push-Pull" Bracing	60" Powder-Coated Aluminum	Cushion	046385161141	12	28.8
2	16117	S550 Professional™	Limited Lifetime	Mini Landscape Rake	17" Heavy-Duty Aluminum	"Push-Pull" Bracing	60" Powder-Coated Aluminum	Cushion	046385161172	12	2.6
3	11100	S600 Power™	Limited Lifetime	Screening Rake	24" Heavy-Duty Aluminum	Wrap-Around Bracing	66" Premium Fiberglass	ProGrip™	046385111009	12	47.0
3	11101	S600 Power™	Limited Lifetime	Screening Rake	30" Heavy-Duty Aluminum	Wrap-Around Bracing	66" Premium Fiberglass	ProGrip™	046385111016	12	49.2
3	11102	S600 Power™	Limited Lifetime	Screening Rake	36" Heavy-Duty Aluminum	Wrap-Around Bracing	66" Premium Fiberglass	ProGrip™	046385111023	12	51.8
3	11103	S600 Power™	Limited Lifetime	Screening Rake	42" Heavy-Duty Aluminum	Wrap-Around Bracing	66" Premium Fiberglass	ProGrip™	046385111030	12	56.8
3	11104	S600 Power™	Limited Lifetime	Screening Rake	48" Heavy-Duty Aluminum	Wrap-Around Bracing	66" Premium Fiberglass	ProGrip™	046385111047	12	62.6
4	11024	S550 Professional™	Limited Lifetime	Screening Rake	24" Heavy-Duty Aluminum	Wrap-Around Bracing	66" Powder-Coated Aluminum	Cushion	046385110248	12	38.4
4	11030	S550 Professional™	Limited Lifetime	Screening Rake	30" Heavy-Duty Aluminum	Wrap-Around Bracing	66" Powder-Coated Aluminum	Cushion	046385110309	12	51.6
4	11036	S550 Professional™	Limited Lifetime	Screening Rake	36" Heavy-Duty Aluminum	Wrap-Around Bracing	66" Powder-Coated Aluminum	Cushion	046385110361	12	55.2
4	11042	S550 Professional™	Limited Lifetime	Screening Rake	42" Heavy-Duty Aluminum	Wrap-Around Bracing	66" Powder-Coated Aluminum	Cushion	046385110422	12	61.2
4	11048	S550 Professional™	Limited Lifetime	Screening Rake	48" Heavy-Duty Aluminum	Wrap-Around Bracing	66" Powder-Coated Aluminum	Cushion	046385110484	12	70.8

WHY A DUAL PURPOSE RAKE?

A Seymour Midwest exclusive. This innovative and versatile tool has two teeth profiles. The short teeth are used for breaking up hard packed clay and grading, while the long teeth are for wet clay and general raking.

CHISEL TOOTH RAKE DESIGN:

The aggressive chisel-sharp teeth and forward grading edge set this rake apart from our others. It is an excellent choice when you need to penetrate and break up hard soils. It also works exceptionally well when spreading concrete or stone.

WHAT IS A MCLEOD RAKE?

A favored tool for firefighters when clearing fire lines, but also a heavy-duty tool for clearing any form of trail or pathway... or even creating a new planting bed or garden. The head measures 9" tall x 11" wide with 4" reinforced teeth.

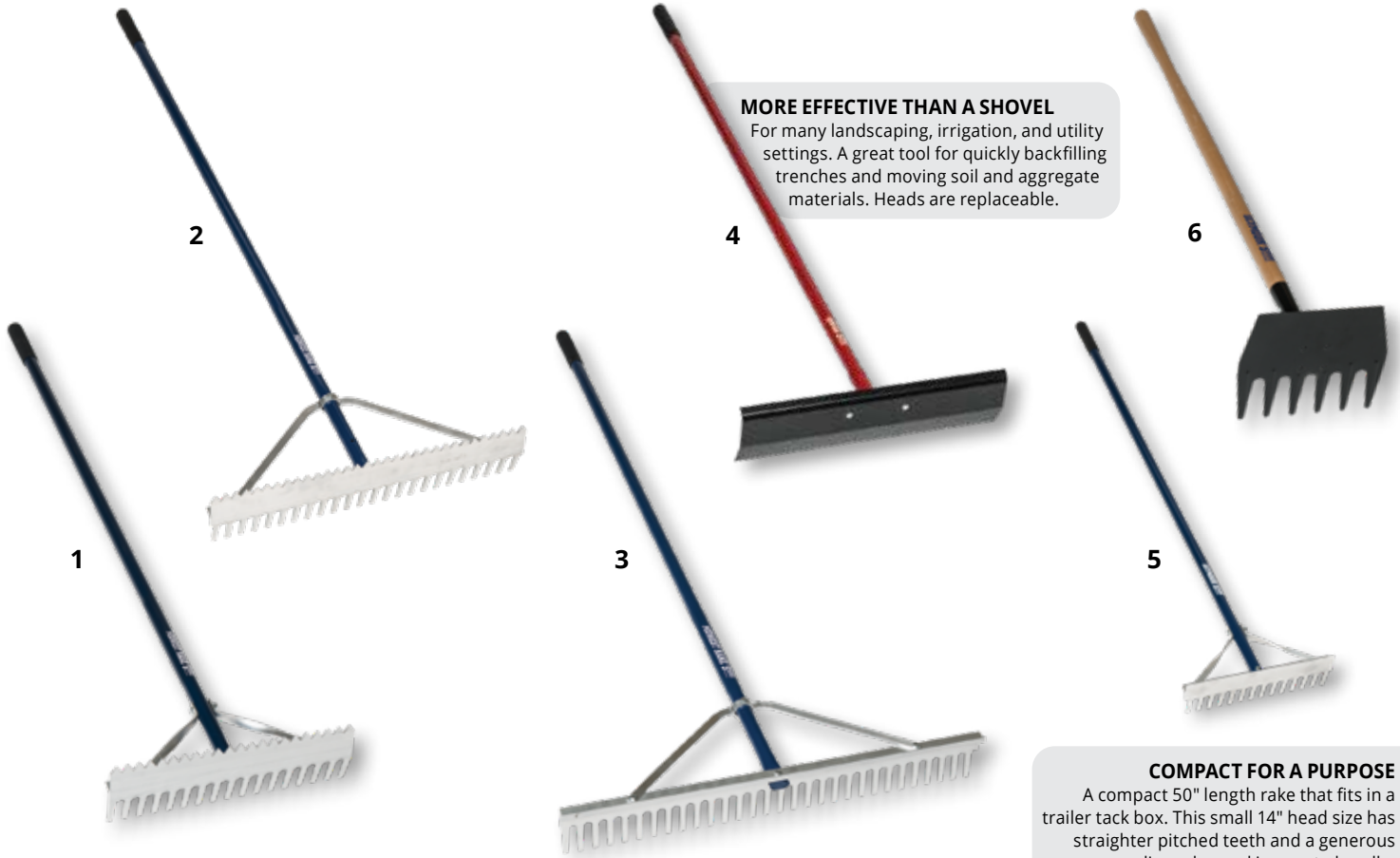

MORE EFFECTIVE THAN A SHOVEL

For many landscaping, irrigation, and utility settings. A great tool for quickly backfilling trenches and moving soil and aggregate materials. Heads are replaceable.

COMPACT FOR A PURPOSE

A compact 50" length rake that fits in a trailer tack box. This small 14" head size has straighter pitched teeth and a generous grading edge and is easy to handle.

Replacement parts available for purchase.

#	SMW #	SERIES	WARRANTY	DESCRIPTION	HEAD STYLE	HEAD-TO-HANDLE	HANDLE TYPE	GRIP	UPC	PACK QTY	PACK WEIGHT
1	12517	S550 Professional™	Limited Lifetime	Dual Purpose Rake	17" Heavy-Duty Aluminum	"Push-Pull" Bracing	60" Powder-Coated Aluminum	Cushion	046385125174	1	2.6
2	12524	S550 Professional™	Limited Lifetime	Dual Purpose Rake	24" Heavy-Duty Aluminum	Wrap-Around Bracing	66" Powder-Coated Aluminum	Cushion	046385125242	1	3.4
2	12536	S550 Professional™	Limited Lifetime	Dual Purpose Rake	36" Heavy-Duty Aluminum	Wrap-Around Bracing	66" Powder-Coated Aluminum	Cushion	046385125365	1	4
3	20024	S550 Professional™	Limited Lifetime	Chisel Tooth Rake	24" Heavy-Duty Aluminum	Wrap-Around Bracing	66" Powder-Coated Aluminum	Cushion	046385200246	12	43.2
3	20030	S550 Professional™	Limited Lifetime	Chisel Tooth Rake	30" Heavy-Duty Aluminum	Wrap-Around Bracing	66" Powder-Coated Aluminum	Cushion	046385200307	12	45.6
3	20036	S550 Professional™	Limited Lifetime	Chisel Tooth Rake	36" Heavy-Duty Aluminum	Wrap-Around Bracing	66" Powder-Coated Aluminum	Cushion	046385200369	12	50.4
3	20042	S550 Professional™	Limited Lifetime	Chisel Tooth Rake	42" Heavy-Duty Aluminum	Wrap-Around Bracing	66" Powder-Coated Aluminum	Cushion	046385200420	12	57.6
3	20048	S550 Professional™	Limited Lifetime	Chisel Tooth Rake	48" Heavy-Duty Aluminum	Wrap-Around Bracing	66" Powder-Coated Aluminum	Cushion	046385200482	12	69.9
3	20060	S550 Professional™	Limited Lifetime	Chisel Tooth Rake	60" Heavy-Duty Aluminum	Wrap-Around Bracing	66" Powder-Coated Aluminum	Cushion	046385200604	12	80.4
4	73320	S550 Irrigation™	Limited Lifetime	Backfill Rake	20" Steel Head	Double Bolted	60" Powder-Coated Aluminum	Cushion	046385733201	1	4.4
5	16113	S500 Industrial™	Limited Lifetime	Horse Trailer Rake	14" Heavy-Duty Aluminum	"Push-Pull" Bracing	50" Powder-Coated Aluminum	Cushion	046385161134	1	2.2
6	41366	S500 Industrial™	Limited Lifetime	McLeod Rake	11" Heat-Treated Steel with 4" Teeth	Welded with Four Rivets	48" Precision Lathe Turned American Hardwood	-	046385413660	1	5.2

A "UTILITY INFIELDER" YOU CAN PLAY EVERYDAY

The perfect size for restoring the pitching mound to a professional surface, just scarify, level, tamp and repeat. Great for shaving and carving the pitching mound. The flat front of this tool can be used as a tamp in secondary areas where light tamping is required.

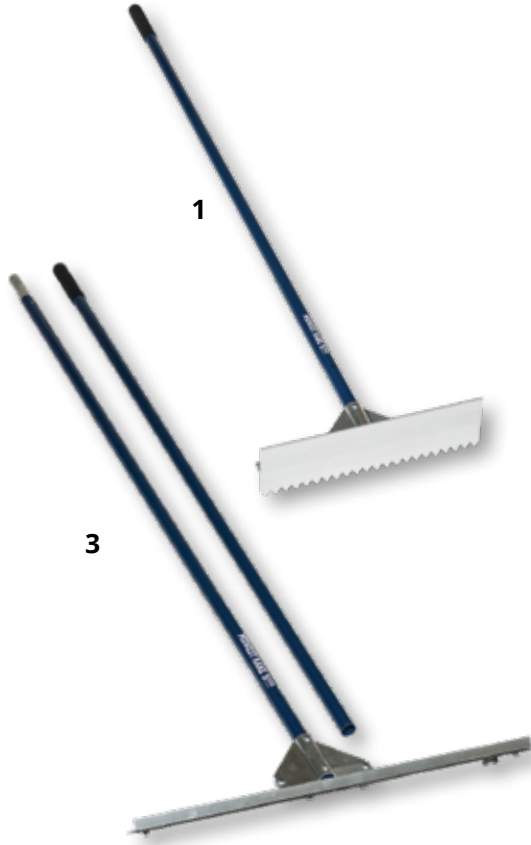

THE PROFESSIONALS CHOICE

Knocks down for easy storage. The perfect tool for grooming infields and beach volleyball courts. The head was designed specifically for the sports turf industry, but it is also highly respected in the professional lawn and garden industry. The high straight edge is excellent for grading.



WIRE WOVEN TEETH

A safe and effective way to seasonally weed lakes, ponds, golf course water traps. Wire woven through heavy-duty teeth uproots aquatic weeds.

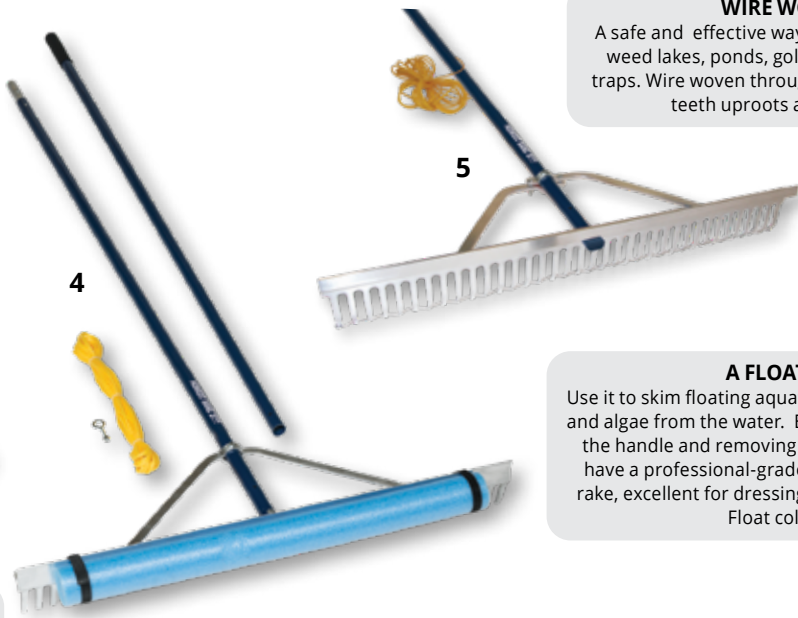

A FLOATING RAKE?

Use it to skim floating aquatic vegetation and algae from the water. By shortening the handle and removing the float, you have a professional-grade landscaping rake, excellent for dressing beach sand. Float colors may vary.

SIMPLY AN AWE-SOME TOOL

The AWE, exclusive to Seymour Midwest, is the most effective bottom-cutting weed removal tool available on the market. No need for dangerous and expensive chemicals; this tool removes weeds at their source. You don't have to worry about the reinforced blades bending under a heavy load of weeds.

SP30100 - Strip, AWE - 28" Super Heavy-Duty Stiffener Bar
SA30018 - 8" Quick Connect Splice for AWE/Lake Rake
SA10024 - AWE 14" Serrated Blades (Set of 2)
SP50065 - 50' Poly Rope for Lake Rake
Additional parts available for purchase.

#	SMW #	SERIES	WARRANTY	DESCRIPTION	HEAD STYLE	HEAD-TO-HANDLE	HANDLE TYPE	GRIP	UPC	PACK QTY	PACK WEIGHT
1	52917	S550 Professional™	Limited Lifetime	Mound & Plate Shaper	17" Heavy-Duty Aluminum	Gusset Bracing	66" Powder-Coated Aluminum	Cushion	046385529170	12	33.6
2	12501	S550 Professional™	Limited Lifetime	Baserunner Field Rake	24" Heavy-Duty Aluminum	Gusset Bracing	39" - 70" Telescoping Fiberglass SuperHandle®	ProGrip™	046385125013	1	3.4
2	12502	S550 Professional™	Limited Lifetime	Baserunner Field Rake	30" Heavy-Duty Aluminum	Gusset Bracing	39" - 70" Telescoping Fiberglass SuperHandle®	ProGrip™	046385125020	1	3.8
2	12503	S550 Professional™	Limited Lifetime	Baserunner Field Rake	36" Heavy-Duty Aluminum	Gusset Bracing	39" - 70" Telescoping Fiberglass SuperHandle®	ProGrip™	046385125037	1	4.2
3	87028	S550 Professional™	Limited Lifetime	A.W.E. - Aquatic Weed Eradicator	28" Serrated Cutting Blade	Gusset Bracing	11' 2-Piece Powder-Coated Aluminum	Cushion	046385870289	12	84
-	87003	S550 Professional™	Limited Lifetime	Extension Handle Section with Splice	-	-	66" Powder-Coated Aluminum	-	046385870036	12	28.8
-	SA10024	S550 Professional™	Limited Lifetime	Replacement Blades for 87028	Set of Two 14" Serrated Blades	-	-	-	046385011576	1	1.32
4	86036	S550 Professional™	Limited Lifetime	Lake Rake	36" Heavy-Duty Aluminum with Float	Wrap-Around Bracing	11' 2-Piece Powder-Coated Aluminum with Rope	Cushion	046385860365	1	7
5	86050	S550 Professional™	Limited Lifetime	Lake Rake	36" Heavy-Duty Aluminum with Wire	Wrap-Around Bracing	66" Powder-Coated Aluminum with Rope	Cushion	046385860501	1	4.6

Our wide selection of professional-quality hoes offers models for every application and user preference. **STANDARD GARDEN HOES** are for general-duty cultivating and cutting.



#	SMW # LEGACY #	SERIES	WARRANTY	DESCRIPTION	HEAD-TO-HANDLE	HANDLE TYPE	GRIP	UPC	PACK QTY	PACK WEIGHT
1	42458 STR-H800	S800 SuperDuty™	Limited Lifetime	Forged 6"	Nylon Adapter & Steel Rivet	60" Premium Fiberglass	ProGrip™	036723008009	4	12.8
2	42455 GH-40	S550 Forged™	Limited Lifetime	Forged 6"	Nylon Adapter & Steel Rivet	54" Industrial Grade Fiberglass	Cushion	031365126005	6	13.2
3	42450 GH-30	S550 Forged™	Limited Lifetime	Forged 6"	Steel Ferrule	60" Precision Lathe Turned American Hardwood	-	031365126012	6	16.8
4	42410	S500 Industrial™	Limited Lifetime	Welded 6"	Solid Steel Rivet & Steel Plug	60" Powder Coated Aluminum	Cushion	046385424109	6	10.4
5	42420 GH-20	S400 Jobsite™	Limited 15 Year	Welded 6"	Steel Ferrule	54" Precision Lathe Turned Hardwood	-	031365126029	6	14.4
6	42425 GH-80	S300 DuraLite™	Limited 5 Year	Welded 6"	Nylon Adapter & Steel Rivet	48" Durable Fiberglass	Cushion	031365126043	6	10.8
7	42448 GH-10	S300 DuraLite™	Limited 5 Year	Welded 6"	Steel Ferrule	54" Precision Lathe Turned Hardwood	-	031365126050	6	14.4
8	42441 GH-90	S200™	Limited 1 Year	Welded 6"	Steel Ferrule	48" Contoured Hardwood with Clear Lacquer Finish	-	031365126067	6	12



Great for moving aggregate and dirt!
The most popular hand tool in Norway.

WARREN HOES have a pointed tip for making furrows and working close to existing plants.
BEET/NURSERY HOES have 3 edges for precise use.

2-WAY LOOP HOES use a rocking action makes light work of regular maintenance in the garden with each push-pull.

63051 - Replacement Head for 42610

SP10105 - Loop Hoe Replacement Head
SP10129 - Loop Hoe Replacement Blade for 42100 & 42141

#	SMW # LEGACY #	SERIES	WARRANTY	DESCRIPTION	HEAD STYLE	HEAD-TO-HANDLE	HANDLE TYPE	GRIP	UPC	PACK QTY	PACK WEIGHT
1	42485	S600 Power™	Limited Lifetime	Norwegian Krafse Hoe	14" Curved Crescent Shape	PowerCore™ & PermaGrip™	48" Premium Fiberglass	ProGrip™	046385424857	4	15.2
2	42460 WH-30	S550 Forged™	Limited Lifetime	Warren Hoe	Forged 6.25"	Steel Ferrule	54" Precision Lathe Turned American Hardwood	-	031365127088	6	13.2
3	42461	S400 Jobsite™	Limited 15 Year	Warren Hoe	Welded 6.25"	Steel Ferrule	54" Precision Lathe Turned Hardwood	-	046385424611	6	13.2
4	42468 SH-36	S400 Jobsite™	Limited 15 Year	Meadow Hoe	Welded 6"	Steel Ferrule	60" Precision Lathe Turned Hardwood	-	031365104027	6	15.6
4	42469 SH-37	S400 Jobsite™	Limited 15 Year	Meadow Hoe	Welded 7"	Steel Ferrule	60" Precision Lathe Turned Hardwood	-	031365104034	6	19.2
5	42465 BH-30	S550 Forged™	Limited Lifetime	Beet / Onion Hoe	Forged 7"	Steel Ferrule	54" Precision Lathe Turned American Hardwood	-	031365126135	6	14.4
6	42610	S550 Irrigation™	Limited Lifetime	2-Way Loop Hoe	6" x 4" Head	Double Bolt	60" Powder-Coated Aluminum	Cushion	046385426103	6	14.4
7	42100	S500 Industrial™	Limited Lifetime	2-Way Loop Hoe	6" x 4" Head	Double Bolt	60" Powder-Coated Aluminum	Cushion	046385421009	6	15.6
8	42141 SH-20	S400 Jobsite™	Limited 15 Year	2-Way Loop Hoe	6" x 4" Head	Double Bolt	54" Precision Lathe Turned Hardwood	-	031365125992	6	14.4
9	42800 2E-AE0	S550 Forged™	Limited Lifetime	Eye Hoe - American Pattern	7" Blade 1-3/4" Diameter Hole	-	-	-	031365103808	3	6
10	42801 2E-AE1	S550 Forged™	Limited Lifetime	Eye Hoe - American Pattern	7.5" Blade 1-3/4" Diameter Hole	-	-	-	031365103907	3	6.6
11	42802 2E-AE2	S550 Forged™	Limited Lifetime	Eye Hoe - American Pattern	7.75" Blade 1-3/4" Diameter Hole	-	-	-	031365104003	3	6.6
12	42805 2E-G60	S550 Forged™	Limited Lifetime	Grub Hoe	4.5" Blade 1-3/4" Diameter Hole	-	-	-	031365105000	3	4.8
13	42808 2E-1G7	S550 Forged™	Limited Lifetime	Italian Grape Hoe	7" Blade	-	-	-	031365106007	3	7.2
14	63011	-	-	Handle for Italian Grape Hoe	Oval Shape	2" x 1-5/8" Diameter	48" Precision Lathe Turned American Hardwood	-	031365010069	3	6.3
15	63001 DG-AEH-60	-	-	Handle for Eye & Grub Hoes	Circular Shape	1-3/4" Diameter	60" Precision Lathe Turned American Hardwood	-	031365010113	3	6.0
15	66682 811-21	-	-	Handle for Eye & Grub Hoes	Circular Shape	1-3/4" Diameter	60" Precision Lathe Turned American Hardwood	-	025545811218	3	6.0
15	63009 DG-AEH	-	-	Handle for Eye & Grub Hoes	Circular Shape	1-3/4" Diameter	54" Precision Lathe Turned American Hardwood	-	031365010052	3	5.4

CULTIVATORS



DUAL-PURPOSE DESIGN!

The perfect tool for weeding and cultivating.

#	SMW # LEGACY #	SERIES	WARRANTY	DESCRIPTION	HEAD STYLE	HEAD-TO-HANDLE	HANDLE TYPE	GRIP	UPC	PACK QTY	PACK WEIGHT
1	42244 GC-40	S550 Forged™	Limited Lifetime	4-Prong	Forged	Nylon Adapter & Steel Rivet	54" Industrial Grade Fiberglass	Cushion	031365127002	6	13.602
2	42254 GC-30	S550 Forged™	Limited Lifetime	4-Prong	Forged	Steel Ferrule	54" Precision Lathe Turned American Hardwood	-	031365127019	6	13.2
3	42204	S500 Industrial™	Limited Lifetime	4-Prong	Welded	Solid Steel Rivet with Steel Plug	60" Powder-Coated Aluminum	Cushion	046385422044	6	15.9
4	42103	S500 Industrial™	Limited Lifetime	3-Prong 2-Way	Welded	Solid Steel Rivet with Steel Plug	60" Powder-Coated Aluminum	Cushion	046385421030	3	7.2
5	42201	S500 Industrial™	Limited Lifetime	1-Prong	Welded	Solid Steel Rivet with Steel Plug	60" Powder-Coated Aluminum	Cushion	046385422013	6	15.6
6	42224 GC-20	S400 Jobsite™	Limited 15 Year	4-Prong	Welded	Steel Ferrule	54" Precision Lathe Turned Hardwood	-	031365127026	6	10.8
7	42004 GC-10	S300 DuraLite™	Limited 5 Year	4-Prong	Welded	Steel Ferrule	54" Precision Lathe Turned Hardwood	-	031365125268	6	10.2

SPADING FORKS are used to work loose soil, aerate sod, dig root crops, transplant bulbs and divide perennial plants.



MANURE FORKS are prized for moving mulch and light material without sifting.

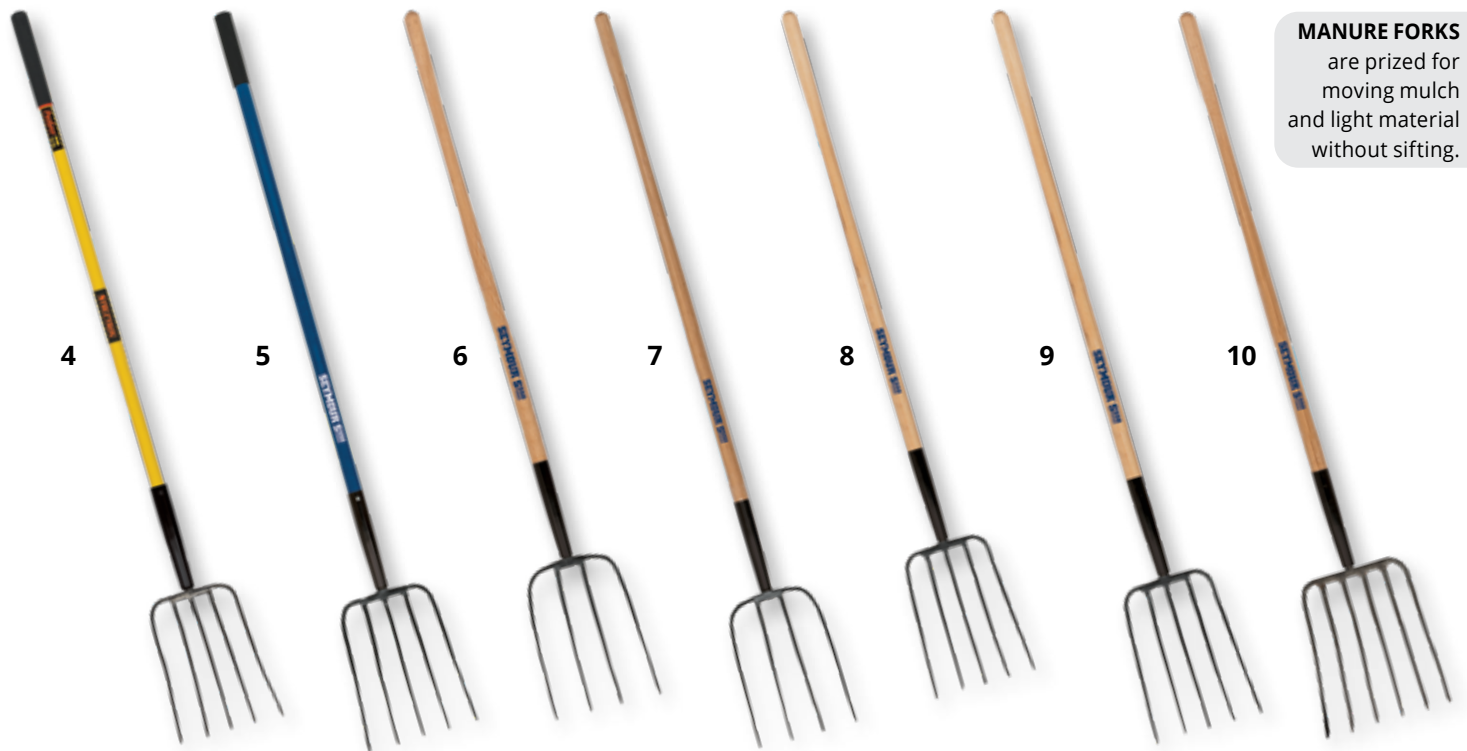

#	SMW # LEGACY #	SERIES	WARRANTY	DESCRIPTION	HEAD STYLE	HEAD-TO-HANDLE	HANDLE TYPE	GRIP	UPC	PACK QTY	PACK WEIGHT
1	49283 SF-40	S550 Forged™	Limited Lifetime	Spading Fork	Forged 4-Tine	8" Ferrule & Solid Steel Rivet	30" Industrial Grade Fiberglass	Poly D	031365124049	3	10.8
2	49077 SF-30	S550 Forged™	Limited Lifetime	Spading Fork	Forged 4-Tine	8" Ferrule & Solid Steel Rivet	29" Precision Lathe Turned American Hardwood	Steel D	031365124001	3	13.8
3	49076 SF-10	S300 DuraLite™	Limited 5 Year	Spading Fork	4-Tine	Steel Ferrule with Solid Steel Rivet	31" Precision Lathe Turned Hardwood	Steel D	031365124032	6	25.2
4	49288 STR-CF5	S800 SuperDuty™	Limited Lifetime	Manure Fork	Forged 5-Tine	Steel Ferrule & Solid Steel Rivet	54" Premium Fiberglass	ProGrip™	036723009051	4	15.2
5	49286 MF-45	S550 Forged™	Limited Lifetime	Manure Fork	Forged 5-Tine	Steel Ferrule & Solid Steel Rivet	48" Industrial Grade Fiberglass	Cushion	031365050218	3	10.2
6	49274 MF-24	S550 Forged™	Limited Lifetime	Manure Fork	Forged 4-Tine	Steel Ferrule	48" Precision Lathe Turned American Hardwood	-	031365050225	3	9.6
7	49275 MF-24L	S550 Forged™	Limited Lifetime	Manure Fork	Forged 4-Tine	Steel Ferrule	54" Precision Lathe Turned American Hardwood	-	031365050232	3	10.8
8	49276 MF-25	S550 Forged™	Limited Lifetime	Manure Fork	Forged 5-Tine	Steel Ferrule	48" Precision Lathe Turned American Hardwood	-	031365050249	3	12.48
9	49277 MF-25L	S550 Forged™	Limited Lifetime	Manure Fork	Forged 5-Tine	Steel Ferrule	54" Precision Lathe Turned American Hardwood	-	031365050256	3	12
10	49278 MF-26	S550 Forged™	Limited Lifetime	Manure Fork	Forged 6-Tine	Steel Ferrule	48" Precision Lathe Turned American Hardwood	-	031365121147	3	13.8

FORKS - HAY, STRAW & ENSILAGE



HAY AND BARLEY STRAW FORKS make it easy to lift and move hay and straw.

ENSILAGE FORKS are for loading and unloading silage and working with mulch.

#	SMW # LEGACY #	SERIES	WARRANTY	DESCRIPTION	HEAD STYLE	HEAD-TO-HANDLE	HANDLE TYPE	GRIP	UPC	PACK QTY	PACK WEIGHT
1	49273 HF-20	S550 Forged™	Limited Lifetime	Hay Fork	Forged 3-Tine	Steel Ferrule	48" Precision Lathe Turned American Hardwood	-	031365050270	3	9.6
2	49279 AF-20	S550 Forged™	Limited Lifetime	Barley/Straw Fork	Forged 5-Tine	Steel Ferrule	54" Precision Lathe Turned American Hardwood	-	031365050294	3	16.2
3	49280 AF-20D	S550 Forged™	Limited Lifetime	Barley/Straw Fork	Forged 5-Tine	Steel Ferrule	30" Precision Lathe Turned American Hardwood	Steel D	031365050331	3	16.8
4	49271	S550 Forged™	Limited Lifetime	Ensilage Fork	Forged 10-Tine	Steel Ferrule	48" Precision Lathe Turned American Hardwood	-	046385492719	3	21
5	49272	S550 Forged™	Limited Lifetime	Ensilage Fork	Forged 10-Tine	Steel Ferrule	30" Precision Lathe Turned American Hardwood	Steel D	046385492726	3	21.6
6	49078 EF-20D	S400 Jobsite™	Limited 15 Year	Ensilage Fork	Welded 10-Tine	Steel Ferrule	30" Precision Lathe Turned American Hardwood	Poly D	031365050317	3	17.7



THIS POTATO/REFUSE FORK is more versatile than its name implies. Its tines are sturdy and ideal for digging or harvesting potatoes and similar types of vegetables. It can also be used to transfer manure and loose material or even for general garden clean-up.

BEDDING FORKS are designed to remove manure from stock bedding. They also work great for spreading mulch, compost and sifting leaves.

#	SMW # LEGACY #	SERIES	WARRANTY	DESCRIPTION	HEAD STYLE	HEAD-TO-HANDLE	HANDLE TYPE	GRIP	UPC	PACK QTY	PACK WEIGHT
1	42256 RF-30	S550 Forged™	Limited Lifetime	Potato/Refuse Fork	Forged 4-Prong 9" x 7"	Solid Steel Rivet	54" Precision Lathe Turned American Hardwood	-	031365050379	3	14.7
2	44111	S400 Jobsite™	Limited 15 Year	Bedding Fork, Individually Boxed	16" Poly	Single Bolt	52" Precision Lathe Turned Hardwood	-	046385441113	1	2.6
2	44111BA BF-20P	S400 Jobsite™	Limited 15 Year	Bedding Fork, Bulk Assembled	16" Poly	Single Bolt	52" Precision Lathe Turned Hardwood	-	031365126234	3	7.3
3	49070 BF-25	S400 Jobsite™	Limited 15 Year	Bedding Fork	Welded 10-Tine	Steel Ferrule	48" Precision Lathe Turned Hardwood	-	031365050287	3	12

SCRAPERS

Scrapers are used to remove ice on walks and drives, remove old flooring and roofing, clean concrete, and for general clean-up on construction sites and farms. These super-duty scrapers are also rugged enough to sever roots and loosen hard-packed soil.



#	SMW # LEGACY #	SERIES	WARRANTY	DESCRIPTION	HEAD STYLE	HEAD-TO-HANDLE	HANDLE TYPE	GRIP	UPC	PACK QTY	PACK WEIGHT
1	49039 STR-SW7	S800 SuperDuty™	Limited Lifetime	Scraper	Forged 7"	Nylon Adapter & Steel Rivet	51" Premium Fiberglass	ProGrip™	036723011023	4	13.6
2	49756	S600 Safety™	Limited Lifetime	Scraper	Forged 7"	Nylon Adapter & Steel Rivet	51" Premium Fiberglass with 3M® Retroreflective Tape	ProGrip™	046385497561	4	13.6
3	49035 SC-30	S550 Forged™	Limited Lifetime	Scraper	Forged 7"	Steel Ferrule with Screw	54" Precision Lathe Turned American Hardwood	-	031365015200	2	7.2
4	49030 SC-20	S500 Industrial™	Limited Lifetime	Scraper	7" Steel	Cast Iron Ferrule with Screw	48" Precision Lathe Turned American Hardwood	-	031365015101	2	6.4
5	49028 SC-25	S500 Industrial™	Limited Lifetime	Scraper	2.5" Steel	Cast Iron Ferrule with Screw	36" Precision Lathe Turned American Hardwood	-	031365015156	2	5.5
6	49029 SC-10	S300 DuraLite™	Limited 5 Year	Scraper	Welded 7"	Welded Ferrule with Bolt	48" Precision Lathe Turned Hardwood	-	031365015002	2	4.0
7	96640 IC-30	S550 Forged™	Limited Lifetime	Ice Chisel	Forged 3.5"	Steel Ferrule with Screw	48" Precision Lathe Turned American Hardwood	-	031365015309	2	6

SUPERSCRAPER™ SCRAPING TOOLS

Used to remove ice on walks and drives, remove old flooring and roofing, clean concrete, and for general clean-up on construction sites and farms. These super-duty scrapers are also rugged enough to sever roots and loosen hard-packed soil.

BARN SCRAPERS

are ideal for general clean up on construction sites and farms 15 Gauge, heavy-duty steel head with steel, dual bracket bracing.



SA11014 - Barn Scraper Replacement Head

#	SMW # LEGACY #	SERIES	WARRANTY	DESCRIPTION	HEAD STYLE	HEAD-TO- HANDLE	HANDLE TYPE	GRIP	UPC	PACK QTY	PACK WEIGHT
1	49031 SC-48	S550 Forged™	Limited Lifetime	SuperScraper™	4" Steel	One Piece Head with Screw	54" Precision Lathe Turned American Hardwood	-	031365000718	2	8.8
2	49032	S550 Forged™	Limited Lifetime	SuperScraper™	4" Steel	One Piece Head with Screw	36" Precision Lathe Turned American Hardwood	Poly D	046385490326	2	8.8
3	49033 SC-79	S550 Forged™	Limited Lifetime	SuperScraper™	7" Steel	One Piece Head with Screw	54" Precision Lathe Turned American Hardwood	-	031365000725	2	10.4
4	49034 SC-79D	S550 Forged™	Limited Lifetime	SuperScraper™	7" Steel	One Piece Head with Screw	36" Precision Lathe Turned American Hardwood	Poly D	031365000732	2	10.4
5	78908	S550 Professional™	Limited Lifetime	Scraper	8" Stainless Steel	Gusset Bracing	66" Powder-Coated Aluminum	Cushion	046385789086	12	30.4
6	78912	S550 Professional™	Limited Lifetime	Scraper	12" Stainless Steel	Gusset Bracing	66" Powder-Coated Aluminum	Cushion	046385789123	12	31.2
6	78916	S550 Professional™	Limited Lifetime	Scraper	16" Stainless Steel	Gusset Bracing	66" Powder-Coated Aluminum	Cushion	046385789161	12	33.6
7	96811 SC-24	S500 Industrial™	Limited Lifetime	Barn Scraper	24" Reversible Steel	Steel Ferrule with Dual Bracket Bracing	60" Precision Lathe Turned American Hardwood	-	031365015224	1	6.8

NXT GENERATION FIBERGLASS

Fifth generation innovative fiberglass handles provide a sure grip under tough working environments.

DOUBLE POWDER COATED HEADS

OVERSTRIKE ZONE

HEADS HAVE POLISHED AND CHAMFERED EDGES

PAD PRINTED HANDLES

DOUBLE INJECTION MOLDED SOLID FIBERGLASS HANDLES

INDUSTRIAL ANTI-SLIP GRIP FOR THE MOST DEMANDING JOBS



OUTPERFORMING THE COMPETITION

HAMMERS & SLEDGES	S500 INDUSTRIAL™	S400 JOBSITE™ FIBERGLASS	S400 JOBSITE™ AMERICAN HICKORY
Drilling	•	•	•
Cross-Pein	•	•	•
Engineer	•	•	•
Sledge Hammers	•	•	•
AXES & MAULS	S500 INDUSTRIAL™	S400 JOBSITE™ FIBERGLASS	S400 JOBSITE™ AMERICAN HICKORY
Camp Axe	•	•	•
Boys Axe			•
Single Bit Michigan Axe	•	•	•
Double Bit Michigan Axe		•	•
Pulaski Axe		•	•
Splitting Maul	•	•	•
PICKS & MATTOCKS	S500 INDUSTRIAL™	S400 JOBSITE™ FIBERGLASS	S400 JOBSITE™ AMERICAN HICKORY
Cutter Mattock		•	•
Pick Mattock	•	•	•
Railroad Pick	•	•	•

We carry a comprehensive assortment, not just the fast running items.



GRAY POWDER COATED HEADS

DOUBLE INJECTION MOLDED SOLID FIBERGLASS HANDLES

GENUINE AMERICAN HICKORY HANDLES

AMERICAN HICKORY

The best replacement handles are made from American hickory because of their strength, elasticity, and ability to absorb shock. Hardwood handles do not conduct electricity.

SHOCK-ABSORBING AMERICAN HICKORY

American hickory is dense, heavy, and a natural shock absorber making it ideal for striking and cutting tool handles.

The long fibers and unique cell structure of American hickory allow it to flex repeatedly and return to its original shape. It absorbs and dissipates shock before it reaches the user's hands.

TURNTED VERSUS SHAPED

Turned handles are ergonomically superior to shaped handles:

Shaped handles are made from thin flat boards that are smoothed and rounded on the top and bottom. Shaping is a faster and less costly way to make handles.

Turned handles are made on a lathe from wood blanks that are about 25% larger than the flat boards. The result is a handle that has ergonomic grips and contours.

Anyone who holds a shaped handle and then a turned handle will immediately feel the comfort and higher quality of the turned handle. We choose to use the turned handle method.

HAMMERS - DRILLING



1-3



4-6



7-9

DRILLING (HAND DRILL) HAMMERS

Used to strike cold chisels, punches, star drills, brick chisels, and hardened nails. They are designed to deliver heavy blows with limited swing in tight spaces.

#	SMW #	SERIES	DESCRIPTION	HANDLE MATERIAL	HANDLE LENGTH	UPC	PACK QTY	PACK WEIGHT	LINK® HANDLE #
1	41805	S500 Industrial™	2 lb Drilling Hammer	Spiral Anti-Slip Grip & Overstrike Protection - Fiberglass	10"	046385418054	6	15.4	65998
2	41806	S500 Industrial™	3 lb Drilling Hammer	Spiral Anti-Slip Grip & Overstrike Protection - Fiberglass	10"	046385418061	6	20.7	65998
3	41809	S500 Industrial™	4 lb Drilling Hammer	Spiral Anti-Slip Grip & Overstrike Protection - Fiberglass	10"	046385418092	6	28.6	65998
4	41807	S400 Jobsite™	2 lb Drilling Hammer	Fiberglass with Cushion Grip & Overstrike Protection	10"	046385418078	6	15.0	65998
5	41811	S400 Jobsite™	3 lb Drilling Hammer	Fiberglass with Cushion Grip & Overstrike Protection	10"	046385418115	6	20.7	65998
6	41812	S400 Jobsite™	4 lb Drilling Hammer	Fiberglass with Cushion Grip & Overstrike Protection	10"	046385418122	6	28.6	65998
7	41850	S400 Jobsite™	2 lb Drilling Hammer	Genuine American Hickory	10"	046385418504	6	15.2	65994
8	41851	S400 Jobsite™	3 lb Drilling Hammer	Genuine American Hickory	10"	046385418511	6	21.1	65994
9	41852	S400 Jobsite™	4 lb Drilling Hammer	Genuine American Hickory	10"	046385418528	6	28.4	65994



CROSS-PEIN (BLACKSMITH) HAMMERS

Used to strike, shape and bend unhardened metal. Also used to shape block, brick, and stone.

#	SMW #	SERIES	DESCRIPTION	HANDLE MATERIAL	HANDLE LENGTH	UPC	PACK QTY	PACK WEIGHT	LINK® HANDLE #
1	41871	S500 Industrial™	3 lb Cross-Pein Hammer	Spiral Anti-Slip Grip & Overstrike Protection - Fiberglass	16"	046385418719	6	20.9	65725
2	41879	S500 Industrial™	4 lb Cross-Pein Hammer	Spiral Anti-Slip Grip & Overstrike Protection - Fiberglass	16"	046385418795	6	28.4	65725
3	41876	S400 Jobsite™	2 lb Cross-Pein Hammer	Fiberglass with Cushion Grip & Overstrike Protection	16"	046385418764	6	15.4	65725
4	41877	S400 Jobsite™	3 lb Cross-Pein Hammer	Fiberglass with Cushion Grip & Overstrike Protection	16"	046385418771	6	20.7	65725
5	41878	S400 Jobsite™	4 lb Cross-Pein Hammer	Fiberglass with Cushion Grip & Overstrike Protection	16"	046385418788	6	28.2	65725
6	41872	S400 Jobsite™	2 lb Cross-Pein Hammer	Genuine American Hickory	16"	046385418726	6	15.4	65720
7	41873	S400 Jobsite™	3 lb Cross-Pein Hammer	Genuine American Hickory	16"	046385418733	6	20.5	65720
8	41874	S400 Jobsite™	4 lb Cross-Pein Hammer	Genuine American Hickory	16"	046385418740	6	28.4	65720

HAMMERS - ENGINEER, RIP, FRAMING, MALLET & DEAD BLOW



ENGINEER HAMMERS (SHORT HANDLE SLEDGES)

Used to strike stone, concrete, metal, and wood. Often used to drive stakes and rods or move timbers. Short handles allow work in tight spaces.

#	SMW #	SERIES	DESCRIPTION	HANDLE MATERIAL	HANDLE LENGTH	UPC	PACK QTY	PACK WEIGHT	LINK® HANDLE #
1	41830	S500 Industrial™	2 lb Engineer Hammer	Spiral Anti-Slip Grip & Overstrike Protection - Fiberglass	15"	046385418306	6	15.6	65725
2	41831	S500 Industrial™	3 lb Engineer Hammer	Spiral Anti-Slip Grip & Overstrike Protection - Fiberglass	15"	046385418313	6	21.1	65725
3	41836	S500 Industrial™	4 lb Engineer Hammer	Spiral Anti-Slip Grip & Overstrike Protection - Fiberglass	16"	046385418368	6	29.0	65725
4	41808	S400 Jobsite™	2 lb Engineer Hammer	Fiberglass with Cushion Grip & Overstrike Protection	16"	046385418085	6	15.4	65725
5	41814	S400 Jobsite™	3 lb Engineer Hammer	Fiberglass with Cushion Grip & Overstrike Protection	16"	046385418146	6	20.7	65725
6	41815	S400 Jobsite™	4 lb Engineer Hammer	Fiberglass with Cushion Grip & Overstrike Protection	16"	046385418153	6	29.0	65725
7	41853	S400 Jobsite™	2 lb Engineer Hammer	Genuine American Hickory	16"	046385418535	6	15.6	65720
8	41854	S400 Jobsite™	3 lb Engineer Hammer	Genuine American Hickory	15"	046385418542	6	20.9	65720
9	41855	S400 Jobsite™	4 lb Engineer Hammer	Genuine American Hickory	16"	046385418559	6	28.4	65720
10	41500	S400 Jobsite™	16 oz. Rip Hammer	Contoured Hardwood Handle	13"	046385415008	1	1.2	N/A
11	41502	S400 Jobsite™	24 oz. Framing Hammer - Milled Face	Contoured Hardwood Handle	15"	046385415022	1	1.8	N/A
12	41501	S400 Jobsite™	16 oz. Rubber Mallet	Contoured Hardwood Handle	10"	046385415015	1	1.0	N/A
13	41503	S400 Jobsite™	32 oz. Dead Blow Hammer	Molded Polymer One-Piece Tool	13"	046385415039	1	0.8	N/A



DOUBLE FACE SLEDGE HAMMERS

Used to strike stone, concrete, metal, and wood. Often used to drive stakes and posts, move timbers, and break concrete.

#	SMW #	SERIES	DESCRIPTION	HANDLE MATERIAL	HANDLE LENGTH	UPC	PACK QTY	PACK WEIGHT	LINK® HANDLE #
1	41837	S500 Industrial™	6 lb Sledge Hammer	Spiral Anti-Slip Grip & Overstrike Protection - Fiberglass	34"	046385418375	2	15.0	64430
2	41838	S500 Industrial™	8 lb Sledge Hammer	Spiral Anti-Slip Grip & Overstrike Protection - Fiberglass	34"	046385418382	2	19.1	64430
3	41839	S500 Industrial™	10 lb Sledge Hammer	Spiral Anti-Slip Grip & Overstrike Protection - Fiberglass	34"	046385418399	2	23.8	64430
4	41833	S500 Industrial™	12 lb Sledge Hammer	Spiral Anti-Slip Grip & Overstrike Protection - Fiberglass	34"	046385418337	2	27.5	64430
5	41834	S500 Industrial™	16 lb Sledge Hammer	Spiral Anti-Slip Grip & Overstrike Protection - Fiberglass	34"	046385418344	1	20.9	64430
6	41835	S500 Industrial™	20 lb Sledge Hammer	Spiral Anti-Slip Grip & Overstrike Protection - Fiberglass	34"	046385418351	1	21.3	64657
7	41825	S400 Jobsite™	6 lb Sledge Hammer	Fiberglass with Cushion Grip & Overstrike Protection	36"	046385418252	2	15.0	64430
8	41820	S400 Jobsite™	8 lb Sledge Hammer	Fiberglass with Cushion Grip & Overstrike Protection	36"	046385418207	2	18.9	64430
9	41818	S400 Jobsite™	10 lb Sledge Hammer	Fiberglass with Cushion Grip & Overstrike Protection	36"	046385418184	2	23.5	64430
10	41819	S400 Jobsite™	12 lb Sledge Hammer	Fiberglass with Cushion Grip & Overstrike Protection	36"	046385418191	2	27.7	64430
11	41823	S400 Jobsite™	16 lb Sledge Hammer	Fiberglass with Cushion Grip & Overstrike Protection	36"	046385418238	1	17.4	64430
12	41824	S400 Jobsite™	20 lb Sledge Hammer	Fiberglass with Cushion Grip & Overstrike Protection	36"	046385418245	1	21.3	64657
13	41856	S400 Jobsite™	6 lb Sledge Hammer	Genuine American Hickory	36"	046385418566	2	14.5	64419
14	41860	S400 Jobsite™	8 lb Sledge Hammer	Genuine American Hickory	36"	046385418603	2	18.9	64419
15	41858	S400 Jobsite™	10 lb Sledge Hammer	Genuine American Hickory	36"	046385418580	2	23.3	64419
16	41859	S400 Jobsite™	12 lb Sledge Hammer	Genuine American Hickory	36"	046385418597	2	27.3	64419
17	41861	S400 Jobsite™	16 lb Sledge Hammer	Genuine American Hickory	36"	046385418610	1	17.4	64419
18	41862	S400 Jobsite™	20 lb Sledge Hammer	Genuine American Hickory	36"	046385418627	1	21.1	64652

AXES - SINGLE BIT MICHIGAN, BOYS & CAMP



SINGLE BIT MICHIGAN AXES

General purpose axes used to fell small trees, split wood, trim branches and prune trees.

SINGLE BIT BOYS AXES

Lighter duty axes used to cut saplings, split kindling, trim branches, and prune trees.

CAMP AXES

Lighter duty axes used to cut saplings, split kindling, trim branches, and prune trees.

#	SMW #	SERIES	DESCRIPTION	HANDLE MATERIAL	HANDLE LENGTH	UPC	PACK QTY	PACK WEIGHT	LINK® HANDLE #
1	41832	S500 Industrial™	3.5 lb Single Bit Michigan Axe	Spiral Anti-Slip Grip & Overstrike Protection - Fiberglass	34"	046385418320	2	11.0	64718
2	41821	S400 Jobsite™	3.5 lb Single Bit Michigan Axe	Fiberglass with Cushion Grip & Overstrike Protection	36"	046385418214	2	10.8	64718
3	41847	S400 Jobsite™	3.5 lb Single Bit Michigan Axe	Genuine American Hickory	36"	046385418474	2	10.6	64709
4	41845	S400 Jobsite™	2.25 lb Boys Axe	Genuine American Hickory	28"	046385418450	2	7.0	64918
5	41840	S400 Jobsite™	1.25 lb Camp Axe	Fiberglass with Cushion Grip & Overstrike Protection	16"	046385418405	2	4.2	N/A
6	41846	S400 Jobsite™	1.25 lb Camp Axe	Genuine American Hickory	16"	046385418467	2	3.7	65309



Photo Credit - USDA Boise National Forest | Boise, Idaho



MICHIGAN DOUBLE BIT AXES

General purpose axes used to fell small trees, split wood, trim branches, and prune trees. Having two bits lengthens the time between blade sharpening.

PULASKI / LANDSCAPING AXES

Combine a single bit axe blade with a mattock blade. This blade combination makes it ideal for fighting forest fires and for a variety of landscaping applications.

#	SMW #	SERIES	DESCRIPTION	HANDLE MATERIAL	HANDLE LENGTH	UPC	PACK QTY	PACK WEIGHT	LINK® HANDLE #
1	41822	S400 Jobsite™	3.5 lb Double Bit Michigan Axe	Fiberglass with Cushion Grip & Overstrike Protection	34"	046385418221	2	10.8	64749
2	41848	S400 Jobsite™	3.5 lb Double Bit Michigan Axe	Genuine American Hickory	36"	046385418481	2	10.6	64745
3	41810	S400 Jobsite™	4 lb Pulaski / Landscaping Axe	Fiberglass with Cushion Grip & Overstrike Protection	36"	046385418108	1	5.5	64749
4	41849	S400 Jobsite™	4 lb Pulaski / Landscaping Axe	Genuine American Hickory	36"	046385418498	1	5.5	64745

SPLITTING MAULS



SPLITTING (WOODCHOPPER) MAULS

Used to split wood. The blade is designed to split rather than cut and the heavy sledge-end adds power to the stroke.

#	SMW #	SERIES	DESCRIPTION	HANDLE MATERIAL	HANDLE LENGTH	UPC	PACK QTY	PACK WEIGHT	LINK® HANDLE #
1	41885	S500 Industrial™	6 lb Splitting Maul	Spiral Anti-Slip Grip & Overstrike Protection - Fiberglass	34"	046385418856	2	15.0	64430
2	41887	S500 Industrial™	8 lb Splitting Maul	Spiral Anti-Slip Grip & Overstrike Protection - Fiberglass	34"	046385418870	2	19.1	64430
3	41886	S400 Jobsite™	6 lb Splitting Maul	Fiberglass with Cushion Grip & Overstrike Protection	36"	046385418863	2	15.2	64430
4	41888	S400 Jobsite™	8 lb Splitting Maul	Fiberglass with Cushion Grip & Overstrike Protection	36"	046385418887	2	18.9	64430
5	41880	S400 Jobsite™	6 lb Splitting Maul	Genuine American Hickory	32"	046385418801	2	14.7	64419
6	41882	S400 Jobsite™	8 lb Splitting Maul	Genuine American Hickory	36"	046385418825	2	18.9	64419
7	41892	S500 Industrial™	4.5 lb Premium Log Splitter	Spiral Anti-Slip Grip & Overstrike Protection - Fiberglass	34"	046385418924	2	12.1	64430
8	41890	S400 Jobsite™	4.5 lb Premium Log Splitter	Fiberglass with Cushion Grip & Overstrike Protection	36"	046385418900	2	11.9	64430



CUTTER MATTOCKS

Combines an axe-like cutter blade with a mattock blade. They are used to chop and dig, especially in hard dirt or clay soils. The cutter blade can be used to cut roots and loosen hard soil. The mattock blade is used to dig or remove loose soil.

PICK MATTOCKS

Combines a pick blade with a mattock blade. They are used to dig or grub, especially in hard dirt or clay soils. The pointed pick blade can be used to loosen hard soil while the broader mattock blade is used to dig or remove loose soil.

#	SMW # LEGACY #	SERIES	DESCRIPTION	HANDLE MATERIAL	HANDLE LENGTH	UPC	PACK QTY	PACK WEIGHT	LINK® HANDLE #
1	85567	S400 Jobsite™	2.5 lb Cutter Mattock	Fiberglass with Cushion Grip & Overstrike Protection	36"	046385855675	1	4.0	64764
2	85573	S400 Jobsite™	5 lb Cutter Mattock	Fiberglass with Cushion Grip & Overstrike Protection	36"	046385855736	1	7.7	64764
3	85566	S400 Jobsite™	2.5 lb Cutter Mattock	Hardwood	36"	046385855668	1	4.0	64762
4	85582	S400 Jobsite™	5 lb Cutter Mattock	Hardwood	36"	046385855828	1	7.7	63025
5	85572	S500 Industrial™	5 lb Pick Mattock	Spiral Anti-Slip Grip & Overstrike Protection - Fiberglass	36"	046385855767	1	7.9	65053
6	85565	S400 Jobsite™	2.5 lb Pick Mattock	Fiberglass with Cushion Grip & Overstrike Protection	36"	046385855651	1	4.1	65053
7	85571	S400 Jobsite™	5 lb Pick Mattock	Fiberglass with Cushion Grip & Overstrike Protection	36"	046385855712	1	7.7	65053
8	85564	S400 Jobsite™	2.5 lb Pick Mattock	Hardwood	36"	046385855644	1	4.0	63025
9	85580	S400 Jobsite™	5 lb Pick Mattock	Hardwood	36"	046385855804	1	7.7	63025
10	63031	Seymour	No. 6 eye, 3" x 2" Pick Mattock Handle with Poly Head	Eucalyptus	36"	046385630319	1	1.8	N/A
11	85520 PM-5H	S400 Jobsite™	5 lb Pick Mattock Head Only	-	-	031365000671	4	20.0	N/A
12	85522 MC-5H	S400 Jobsite™	5 lb Cutter Mattock Head Only	-	-	031365000688	4	20.0	N/A



RAILROAD (CLAY) PICKS

Combine a pointed pick blade with a pick blade that has a narrow cutting edge. They are used to dig and loosen soil, especially in hard dirt or clay soils. The pointed pick blade can be used for deeper penetration while the other blade can be used for cutting and digging.

#	SMW # LEGACY #	SERIES	DESCRIPTION	HANDLE MATERIAL	HANDLE LENGTH	UPC	PACK QTY	PACK WEIGHT	LINK® HANDLE #
1	85576	S500 Industrial™	5 lb Railroad Pick	Spiral Anti-Slip Grip & Overstrike Protection - Fiberglass	36"	046385855767	1	7.9	65053
2	85578	S500 Industrial™	6 lb Railroad Pick	Spiral Anti-Slip Grip & Overstrike Protection - Fiberglass	36"	046385855781	1	9.0	65053
3	85575	S400 Jobsite™	5 lb Railroad Pick	Fiberglass with Cushion Grip & Overstrike Protection	36"	046385855750	1	7.7	65053
4	85577	S400 Jobsite™	6 lb Railroad Pick	Fiberglass with Cushion Grip & Overstrike Protection	36"	046385855774	1	8.8	65053
5	85585	S400 Jobsite™	5 lb Railroad Pick	Hardwood	36"	046385855866	1	7.7	63025
6	85586	S400 Jobsite™	6 lb Railroad Pick	Hardwood	36"	046385855859	1	8.6	63025
7	85525 RP-5H	S400 Jobsite™	5 lb Railroad Pick Head Only	-	-	031365000695	4	20.0	N/A
8	85526 RP-6H	S400 Jobsite™	6 lb Railroad Pick Head Only	-	-	031365000701	4	24.0	N/A

TAMPERS & WEDGES



TAMPERS make it easy to compact loose soil, sand and aggregate. They are a must-have tool for preparing a foundation for paving surfaces on drives, walks and patios. They also prized for compacting trenches and for making sod repairs.

#	SMW # LEGACY #	SERIES	DESCRIPTION	HEAD STYLE	HEAD-TO-HANDLE	HANDLE TYPE	GRIP	UPC	PACK QTY	PACK WEIGHT
1	85078 TP-8FG	S800 SuperDuty™	Tamper	8" x 8" Cast Iron	Single Screw	45" Premium Fiberglass	ProGrip™	031365000633	2	21.6
2	85054	S550 Irrigation™	Tamper	4" x 10" Heavy Duty Steel	Welded with Four Braces	58" Extra Length All-Steel	12" Double Dip	046385850540	1	14.2
3	85008	S550 Irrigation™	Tamper	8" x 8" Heavy Duty Steel	Welded with Four Braces	48" All-Steel	12" Double Dip	046385850083	1	16.2
4	85058	S550 Irrigation™	Tamper	8" x 8" Heavy Duty Steel	Welded with Four Braces	58" Extra Length All-Steel	12" Double Dip	046385850588	1	18.2
5	85010	S550 Irrigation™	Tamper	10" x 10" Heavy Duty Steel	Welded with Four Braces	48" All-Steel	12" Double Dip	046385850106	1	17.4
6	85050	S550 Irrigation™	Tamper	10" x 10" Heavy Duty Steel	Welded with Four Braces	58" Extra Length All-Steel	12" Double Dip	046385850502	1	19.2
7	85088 TP-30	S550 Irrigation™	Tamper	8" x 8" Cast Iron	Wedge and Screw with Four Braced Corners	44" Precision Lathe Turned American Hardwood	-	031365129099	4	47.2
8	85090 TP-32	S550 Irrigation™	Tamper	10" x 10" Cast Iron	Wedge and Screw with Four Braced Corners	44" Precision Lathe Turned American Hardwood	-	031365129082	4	59.2
9	85060	S500 Industrial™	Tamper	10" x 10" Heavy Duty Steel	Welded with Four Braces	52" Extra Length All-Steel Handle	14" Cushion	046385850601	1	13.4
10	85068	S500 Industrial™	Tamper	8" x 8" Heavy Duty Steel	Welded with Four Braces	52" Extra Length All-Steel Handle	14" Cushion	046385850687	1	10.6
11	41593	S400 Jobsite™	Wood-Splitting Wedge	3 lb. All-Steel	-	-	-	046385415930	4	11.5
12	41594 WW-4	S400 Jobsite™	Wood-Splitting Wedge	4 lb. All-Steel	-	-	-	031365000350	4	15.2
13	41595 WW-5	S400 Jobsite™	Wood-Splitting Wedge	5 lb. All-Steel	-	-	-	031365000367	4	19.264
14	41596 WW-6	S400 Jobsite™	Wood-Splitting Wedge	6 lb. All-Steel	-	-	-	031365000374	4	25.6
15	41599	S400 Jobsite™	Grenade Wedge	3.5 lb. / 7" Long All-Steel	-	-	-	046385415992	1	3.5

BARS - WRECKING, STRIPPING, UTILITY & NAIL PULLER



WRECKING (GOOSENECK) BARS

Used to pull nails and to pry apart wood. They have a nail puller head on the gooseneck end. The gooseneck provides leverage for heavy pulling. The other end has a bent chisel head for prying.

#	SMW # LEGACY #	SERIES	DESCRIPTION	UPC	PACK QTY	PACK WEIGHT
1	85300 WR-12	S400 Jobsite™	12" Wrecking Bar	031365000480	1	2.4
2	85301 WR-18	S400 Jobsite™	18" Wrecking Bar	031365000497	1	7.2
3	85302 WR-24	S400 Jobsite™	24" Wrecking Bar	031365000503	1	11.2
4	85305 WR-30	S400 Jobsite™	30" Wrecking Bar	031365000510	1	13.6
5	85303 WR-36	S400 Jobsite™	36" Wrecking Bar	031365000527	1	18.4
6	85306	S400 Jobsite™	42" Wrecking Bar	046385853060	1	7.0
7	85304	S400 Jobsite™	48" Wrecking Bar	046385853046	1	23.6
8	85307	S400 Jobsite™	42" Stripping Bar	046385853077	1	10.1
9	85308	S400 Jobsite™	48" Stripping Bar	046385853084	1	11.6
10	85350	S400 Jobsite™	13" Utility Bar	046385853503	1	1.1
11	85351	S400 Jobsite™	15" Utility Bar	046385853510	1	1.6
12	85353	S400 Jobsite™	21" Utility Bar	046385853534	1	2.1
13	85356	S400 Jobsite™	11" Nail Puller - Double End	046385853565	1	1.2

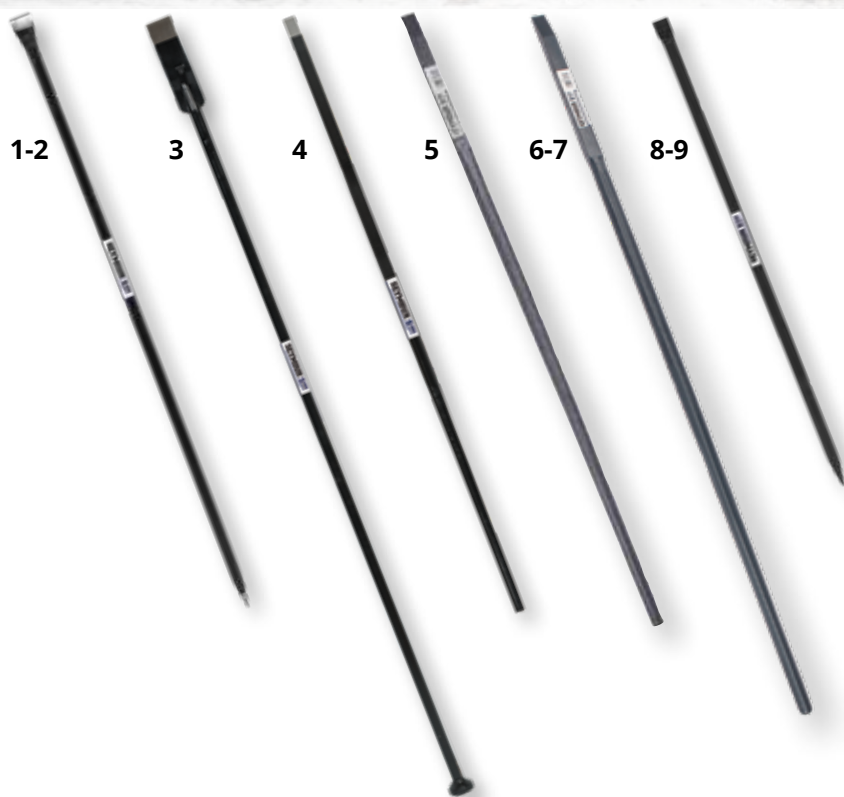

SAN ANGELO BARS

Chisel head on one end and a diamond point on the other end. They are used to pry and dig.

POST HOLE TAMPING BARS

Chisel head on one end and a tamper point on the other end. The chisel end is used to dig or loosen soil in post holes. The tamper end is used to pack the soil around posts that have been set in the holes. Also great for moving rocks from soil.

WEDGE POINT CROW BARS

Wedge shaped point. They are used to pry or move heavy objects and to split or separate wood, metal, or concrete forms.

PINCH POINT CROW BARS

Slanted point. They are used to pry or move heavy objects and to split or separate wood, metal, or concrete forms.

#	SMW # LEGACY #	SERIES	DESCRIPTION	HANDLE STYLE	HANDLE LENGTHS	UPC	PACK QTY	PACK WEIGHT
1	85364	S400 Jobsite™	14 lb San Angelo Bar	1" Hex Shank	60"	046385853640	1	14.0
2	85367 DG-23	S400 Jobsite™	17 lb San Angelo Bar	1" Hex Shank	72"	031365012216	1	17.0
3	85366 DG-19	S400 Jobsite™	17 lb Post Hole Tamping Bar	1" Round Shank	72"	031365012209	1	16.8
4	85365 DG-WP60	S400 Jobsite™	18 lb Wedge Point Bar	1.25" Round Shank	60"	031365000039	1	18.0
5	85358	S400 Jobsite™	12 lb Pinch Point Bar	1.25" Shank	51"	046385853589	1	12.0
6	85368 DG-PP60	S400 Jobsite™	18 lb Pinch Point Bar	1.25" Shank	60"	031365000022	1	18.2
7	85369	S400 Jobsite™	22 lb Pinch Point Bar	1.25" Shank	64"	046385853695	1	22.0
8	85360 SB-48	S400 Jobsite™	11 lb Slate Bar	1" Hex Shank	48"	031365000589	1	10.8
9	85361 SB-60	S400 Jobsite™	14 lb Slate Bar	1" Hex Shank	60"	031365000602	1	13.0

WHEELBARROWS - EXCAVATOR®

EXCAVATOR CONSTRUCTION:

- All steel design assembles in less than 10 minutes
- The 6 cubic foot tray is reinforced at the bottom with a heavy-duty 1/4" thick "H" shaped support to prevent damage when used for hauling rock or concrete
- The front roll bar supports heavy loads when dumping
- The location of the cross bar does not impede step

WHY CONTRACTORS PREFER "FLAT-FREE" TIRES:

- No employee down-time due to flats
- Roll over nails, glass, staples without worries
 - Eliminates maintenance and spare parts
 - No need to carry an air pump
 - Same bounce and load handling
 - Abrasion, chemical and UV resistant



1



2



3



4



5



6

SP50080 - Replacement Grips for Wheelbarrows

63201 - Replacement Tire for 85730 & 85732

63211 - Replacement Tire for 85731, 85733, 85736, & 85738

63212 - Dual Wheel Kit that can Transform 85731 into 85733

63202 - Dual Wheel Kit that can Transform 85730 into 85732

#	SMW #	SERIES	DESCRIPTION	TRAY	FRAME	HANDLE	TIRE	UPC	PACK QTY	PACK WEIGHT
1	85736	S600 Power™	Steel Wheelbarrow	6 Cu. Ft. 1.2mm Tray	One-Piece Steel Frame	Steel with Cushion Grip	15" Flat-Free Knobby Rubber	046385857365	1	62.7
2	85738	S600 Power™	Steel Wheelbarrow	6 Cu. Ft. 1.2mm Tray	One-Piece Steel Frame	Steel with Cushion Grip	Dual 15" Flat-Free Knobby Rubber	046385857389	1	75.5
3	85731	S500 Industrial™	Steel Wheelbarrow	6 Cu. Ft. 1.0mm Tray	One-Piece Steel Frame	Steel with Cushion Grip	15" Flat-Free Knobby Rubber	046385857310	1	56.0
4	85733	S500 Industrial™	Steel Wheelbarrow	6 Cu. Ft. 1.0mm Tray	One-Piece Steel Frame	Steel with Cushion Grip	Dual 15" Flat-Free Knobby Rubber	046385857334	1	68.8
5	85730	S500 Industrial™	Steel Wheelbarrow	6 Cu. Ft. 1.0mm Tray	One-Piece Steel Frame	Steel with Cushion Grip	16" Standard Knobby Tire	046385857303	1	54.4
6	85732	S500 Industrial™	Steel Wheelbarrow	6 Cu. Ft. 1.0mm Tray	One-Piece Steel Frame	Steel with Cushion Grip	16" Dual Standard Knobby Tire	046385857327	1	65.6

POLY & STEEL - WHEELBARROWS



1



2



3



4



5



6

SA32007 - Carriage for 85740
 SA32005 - Carriage for 85724
 SA32006 - Carriage for 85765
 SA32010 - Carriage for Children's Wheelbarrow
 63213 - Replacement Tire for 85724
 63203 - Replacement Tire for 85740

SP50401 - Replacement Handle for 85740
 SP50402 - Replacement Handle for 85724
 SP50403 - Replacement Handle for 85765
 SP50430 - Replacement Tray for 85769, 85772, & 85770
 SP50080 - Replacement Grips for Steel Handle Wheelbarrows

#	SMW # LEGACY #	SERIES	DESCRIPTION	TRAY	BRACES	HANDLE	TIRE	UPC	PACK QTY	PACK WEIGHT
1	85765 WB-10P	S500 Industrial™	Poly Wheelbarrow	10 Cu. Ft.	Front Tray & Cross Braces	Hardwood	Dual 16" 2-Ply with Ball Bearings	031365129204	1	45.1
2	85724 WB-6SHDS	S500 Industrial™	Steel Wheelbarrow	6 Cu. Ft.	Front Tray & Cross Braces	Steel	15" Flat Free with Ball Bearings	031365129303	1	43.8
3	85740 WB-6SHD	S400 Jobsite™	Steel Wheelbarrow	6 Cu. Ft.	Front Tray & Cross Braces	Hardwood	16" 2-Ply Knobby with Ball Bearings	031365129181	1	43.8
4	85769	S400 Jobsite™	Steel Wheelbarrow	6 Cu. Ft.	Front Tray & Cross Braces	Hardwood	16" Standard Tire	046385857693	1	37.3
5	85772	S400 Jobsite™	Steel Wheelbarrow	6 Cu. Ft.	Front Tray & Cross Braces	Steel	16" Flat-Free Knobby Rubber	046385857723	1	40.9
5	85770	S400 Jobsite™	Steel Wheelbarrow	6 Cu. Ft.	Front Tray & Cross Braces	Hardwood	16" Flat-Free Knobby Rubber	046385857709	1	40.1
6	85720 WB-JR	S400 Jobsite™	Children's Poly Wheelbarrow	Small	Front Tray Braces	Hardwood	8" Solid Rubber with Ball Bearings	031365129297	1	9.5
6	85720PP WB-JRD	S400 Jobsite™	Children's Poly Wheelbarrow / POP Display	Small	Front Tray Braces	Hardwood	8" Solid Rubber with Ball Bearings	031365129525	1	97.8
6	85720IB WB-JRB	S400 Jobsite™	Children's Poly Wheelbarrow / Individually Boxed	Small	Front Tray Braces	Hardwood	8" Solid Rubber with Ball Bearings	031365129310	1	10.5

WHEELBARROWS - POLY & STEEL



SA32008 - Carriage for 85725
 SA32004 - Carriage for 85721
 SP50401 - Replacement Handle for 85725

#	SMW # LEGACY #	SERIES	DESCRIPTION	TRAY	BRACES	HANDLE	TIRE	UPC	PACK QTY	PACK WEIGHT
1	85725 WB-6P	S300 DuraLite™	Poly Wheelbarrow	6 Cu. Ft.	Front Tray & Cross Braces	Hardwood	16" 2-Ply with Ball Bearings	031365129167	1	31.3
2	85718	S300 DuraLite™	Steel Wheelbarrow	6 Cu. Ft.	Front Tray & Cross Braces	Hardwood	15" 2-Ply Standard Knobby Tire	046385857181	1	34.8
3	85721 WB-4S	S300 DuraLite™	Steel Wheelbarrow	4 Cu. Ft.	Front Tray Braces	Hardwood	15" 2-Ply with Ball Bearings	031365129150	1	29.1

EXTENSION HANDLES

SUPERHANDLE® II DUAL LOCKING SYSTEM

The world's first extension handle with two locking systems to ensure the most secure handle lock available today. Built to industrial quality standards for outstanding performance and durability.

EXTERNAL LOCK

Screw down threaded collar to secure handle in any position. Comfortable ergonomic design.

INTERNAL LOCK

Twist inner pole with STĀ-LOK® positive locking system until it snaps into locking position to quickly secure handle at any length.

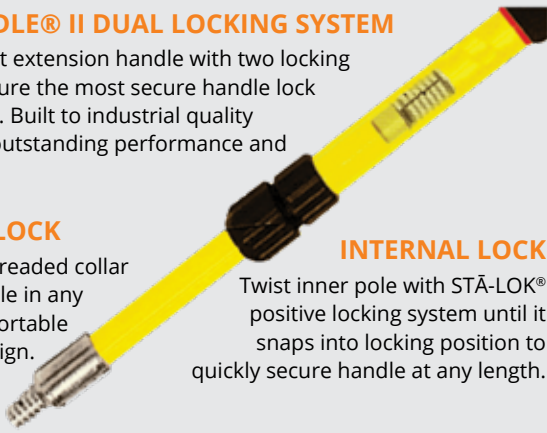

UPGRADE TO ULTRA

Our new "Ultra" version includes a virtually indestructible threaded tip milled from solid aluminum bar stock. Use it for heavier-weight ends or when the tool end will be subject to high leverage forces.

SA22028 - Collar Lock For SuperHandle® Handles
SA32002 - 1" STĀ-LOK® Repair Kit for Super Handle II
SP20022 - Tip Adapter

#	SMW # LEGACY #	SERIES	WARRANTY	DESCRIPTION	HEAD STYLE	HANDLE TYPE	GRIP	UPC	PACK QTY	PACK WEIGHT
1	60270	S800 SuperDuty™	Limited Lifetime	SuperHandle II® Ultra with STĀ-LOK®	Threaded #5 ACME Precision Tip Milled from a Solid Bar of Aluminum	1' - 2' Fiberglass Handle	End Cap	036723602702	6	3.6
1	60271	S800 SuperDuty™	Limited Lifetime	SuperHandle II® Ultra with Dual Lock	Threaded #5 ACME Precision Tip Milled from a Solid Bar of Aluminum	2' - 4' Fiberglass Handle	ProGrip™	036723602719	6	9
1	60276	S800 SuperDuty™	Limited Lifetime	SuperHandle II® Ultra with Dual Lock	Threaded #5 ACME Precision Tip Milled from a Solid Bar of Aluminum	3' - 6' Fiberglass Handle	ProGrip™	036723602764	6	3.6
1	60272	S800 SuperDuty™	Limited Lifetime	SuperHandle II® Ultra with Dual Lock	Threaded #5 ACME Precision Tip Milled from a Solid Bar of Aluminum	4' - 8' Fiberglass Handle	ProGrip™	036723602726	6	12
1	60273	S800 SuperDuty™	Limited Lifetime	SuperHandle II® Ultra with Dual Lock	Threaded #5 ACME Precision Tip Milled from a Solid Bar of Aluminum	6' - 12' Fiberglass Handle	ProGrip™	036723602733	6	16.8
1	60274	S800 SuperDuty™	Limited Lifetime	SuperHandle II® Ultra with Dual Lock	Threaded #5 ACME Precision Tip Milled from a Solid Bar of Aluminum	8' - 16' Fiberglass Handle	ProGrip™	036723602740	6	18
1	60275	S800 SuperDuty™	Limited Lifetime	SuperHandle II® Ultra with Dual Lock	Threaded #5 ACME Precision Tip Milled from a Solid Bar of Aluminum	8' - 24' Fiberglass Handle (3-Section)	ProGrip™	036723602757	3	16.5
2	60250 STR-SE12	S600 Power™	Limited Lifetime	SuperHandle II® with STĀ-LOK®	Threaded #5 ACME Zinc Die Cast Tip	1' - 2' Fiberglass Handle	End Cap	036723002120	6	4.8
2	60251 STR-SE24	S600 Power™	Limited Lifetime	SuperHandle II® with Dual Lock	Threaded #5 ACME Zinc Die Cast Tip	2' - 4' Fiberglass Handle	ProGrip™	036723002243	6	8.4
2	60256 STR-SE36	S600 Power™	Limited Lifetime	SuperHandle II® with Dual Lock	Threaded #5 ACME Zinc Die Cast Tip	3' - 6' Fiberglass Handle	ProGrip™	036723002366	6	9.6
2	60252 STR-SE48	S600 Power™	Limited Lifetime	SuperHandle II® with Dual Lock	Threaded #5 ACME Zinc Die Cast Tip	4' - 8' Fiberglass Handle	ProGrip™	036723002489	6	13.2
2	60253 STR-SE612	S600 Power™	Limited Lifetime	SuperHandle II® with Dual Lock	Threaded #5 ACME Zinc Die Cast Tip	6' - 12' Fiberglass Handle	ProGrip™	036723026126	6	20.5
2	60254 STR-SE816	S600 Power™	Limited Lifetime	SuperHandle II® with Dual Lock	Threaded #5 ACME Zinc Die Cast Tip	8' - 16' Fiberglass Handle	ProGrip™	036723028168	6	22.8
2	60255 STR-SE824	S600 Power™	Limited Lifetime	SuperHandle II® with Dual Lock	Threaded #5 ACME Zinc Die Cast Tip	8' - 24' Fiberglass Handle (3-Section)	ProGrip™	036723028243	3	18.6
3	60245 STR-CE24	S600 Power™	Limited Lifetime	SuperHandle® with External Collar Lock	Threaded #5 ACME Zinc Die Cast Tip	2' - 4' Fiberglass Handle	ProGrip™	036723001246	6	7.2
3	60244 STR-CE36	S600 Power™	Limited Lifetime	SuperHandle® with External Collar Lock	Threaded #5 ACME Zinc Die Cast Tip	3' - 6' Fiberglass Handle	ProGrip™	036723001369	6	9.6
3	60246 STR-CE48	S600 Power™	Limited Lifetime	SuperHandle® with External Collar Lock	Threaded #5 ACME Zinc Die Cast Tip	4' - 8' Fiberglass Handle	ProGrip™	036723001482	6	12
3	60247 STR-CE612	S600 Power™	Limited Lifetime	SuperHandle® with External Collar Lock	Threaded #5 ACME Zinc Die Cast Tip	6' - 12' Fiberglass Handle	ProGrip™	036723016127	6	18
3	60248 STR-CE816	S600 Power™	Limited Lifetime	SuperHandle® with External Collar Lock	Threaded #5 ACME Zinc Die Cast Tip	8' - 16' Fiberglass Handle	ProGrip™	036723018169	6	21.6
4	60240 STR-SS48	S600 Power™	Limited Lifetime	Straight Single-Length	Threaded #5 ACME Zinc Die Cast Tip	48" Premium Fiberglass	End Cap	036723012488	6	4.8
4	60241 STR-SS60	S600 Power™	Limited Lifetime	Straight Single-Length	Threaded #5 ACME Zinc Die Cast Tip	60" Premium Fiberglass	End Cap	036723002601	6	7.2
4	60242 STR-SS7	S600 Power™	Limited Lifetime	Straight Single-Length	Threaded #5 ACME Zinc Die Cast Tip	72" Premium Fiberglass	End Cap	036723002724	6	9.1
5	60279	S800 SuperDuty™	Limited Lifetime	Replacement Tip with Rivet	Milled from a Solid Bar of Aluminum	N/A	N/A	046385602798	1	0.3
6	60259 STR-465	S600 Power™	Limited Lifetime	Replacement Tip with Rivet	Zinc Die Cast	N/A	N/A	031365053424	1	0.2

We offer the industry's widest selection of replacement handles that help you extend the life of your trusted tools. With over 6,000 handle patterns available, we can provide an exact match that fits the tool with an ergonomically-superior turned design.



LINK® HANDLES

FACTS TO KNOW WHEN SELECTING A REPLACEMENT HANDLE

Tool handles can be made from a variety of hardwoods as well as fiberglass and steel. Each material has certain advantages and disadvantages for replacement handles.

American hickory and other hardwoods

The best replacement handles are made from American hickory other American hardwoods because of their strength, elasticity, and ability to absorb shock. Hardwood handles do not conduct electricity.

Shock-absorbing American hickory

American hickory is dense, heavy, and a natural shock absorber making it ideal for striking and cutting tool handles.

The long fibers and unique cell structure of American hickory allow it to flex repeatedly and return to its original shape. It absorbs and dissipates shock before it reaches the user's hands.

The best hickory is grown in the Tennessee region of the USA

The best American hickory logs come from Tennessee, Kentucky, North Carolina, and South Carolina. This region has the ideal combination of soil minerals, rainfall, and sunshine to produce trees that grow slowly and uniformly for exceptional strength.

Wood from slower growing trees is denser and thus stronger than the lighter wood that comes from faster growing trees.

All Link® hickory comes from the Tennessee region of the USA. Some hickory grows in the northeastern United States, but it is generally of lower quality than the hickory grown in the Tennessee region.

American hardwood handles for agricultural tools

Many agricultural tool handles such as shovels, rakes, and hoes are made from American hardwood. It has a uniform grain structure that provides both the strength and the elasticity needed for the bending stresses these tools must endure.

Other hardwoods

When ash or hickory is not used, other hardwoods suitable for the application are selected.

While ash gives the finest strength to weight ratio, handles of other hardwoods are appropriately selected for many types of tools.

Fiberglass handles

Fiberglass handles are strong, lightweight, and do not conduct electricity. Fiberglass, however, is not flexible and *does not absorb shock*. Fiberglass handles cost more than hardwood handles.

Link® offers fiberglass replacement handles.

Steel handles

Steel handles are extremely strong, but they are *heavy* and *expensive*. They are *not flexible* and *do not absorb shock*. Steel handles conduct electricity.



Vintage logo from the Sequatchie Handle Works

Choose our shock-absorbing hickory handles for striking or cutting tools. The unique fibers of **American Tennessee hickory** provide outstanding **durability and shock absorption** for less wear-and-tear on the user. It's no wonder why drumsticks are made of hickory!

TURNED VERSUS SHAPED

Turned handles are ergonomically superior to shaped handles

There are two ways to produce handles: shaping and turning.

Shaped handles are made from thin flat boards that are smoothed and rounded on the top and bottom. Shaping is a faster and less costly way to make handles.

Turned handles are made on a lathe from wood blanks that are about 25% larger than the flat boards. The result is a handle that has superior grips and contours.

Anyone who holds a shaped handle and then a turned handle will immediately feel the comfort and higher quality of the turned handle. Link® Handles chooses to use the turned handle method.

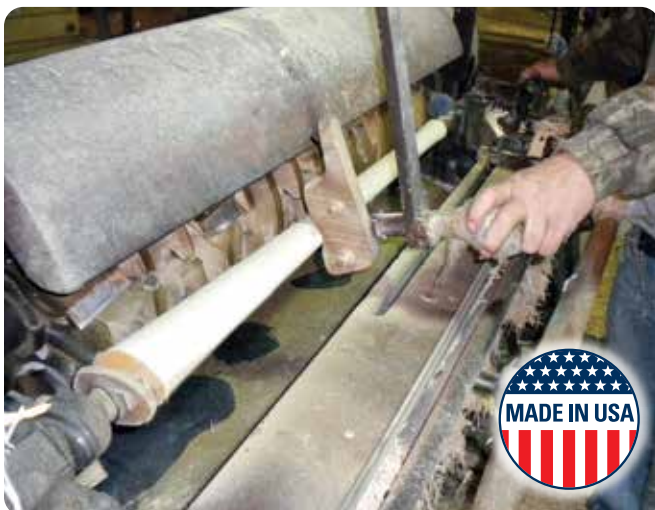

The best replacement handles are turned rather than shaped. Turning results in ergonomically-superior handles that provide better comfort, control, and safety.

Shaped

Turned

Only Link® Handles offer superior ergonomic design

Link® handles are designed with the best combination of length and contours so the user can best hold the handle and use the tool.

Our handle shape always works with the user. The handle becomes an extension of the body to provide better comfort, control, and safety.



WE TAKE THESE STEPS IN MAKING EVERY TURNED AXE HANDLE:

1. Start with an American Tennessee Hickory Log



2. Axe wood square or blank.



3. Half turned axe handle.



4. Full rough turned axe handle.



5. Axe handle after sanding.



6. Finished axe handle with label and wedge.

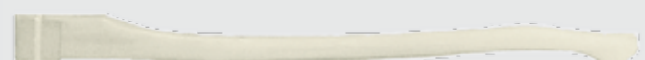

Link® Handles have set the industry benchmark for when it comes to what customers care about most: consistent quality, outstanding ergonomics and exact fit matches to over 6,000 tools.

LINK® HANDLES

ALL HANDLES ARE CAREFULLY GRADED & SORTED

Our experienced timber buyers grade log quality. They are looking for logs that are heavy and defect-free.

When the logs are sawed into squares (or blanks), the squares are graded. After the squares are turned into handles, they are graded again.

PRIMARY LOG QUALITY FACTORS

Some of the factors used to determine quality include:

STRAIGHTNESS OF GRAIN

MOISTURE CONTENT

DENSITY

FREEDOM FROM DEFECTS

WOOD COLOR NOT A QUALITY FACTOR

Color of the wood is not a factor in determining the quality of hickory handles. The best hickory handles may be all white, red-and-white, or all red.

LINK® AMERICAN HICKORY QUALITY LEVELS

01 Best quality American hickory with sanded finish and yellow non-slip grip. Meets or exceeds all government "A" specifications. Ideal for the most demanding industrial and commercial applications.

02 Best quality American hickory with a wax finish. Meets or exceeds all government "A" specifications. Ideal for the most demanding industrial and commercial applications.

08 Better quality American hickory with a wax finish. Ideal for frequent heavy-duty use by farmers, ranchers, contractors and other professionals with demanding construction and other professional applications.

19 Better quality American hickory with a clear lacquer finish. Fire finish provides a highly pleasing appearance. Ideal for frequent heavy-duty use by farmers, ranchers, contractors and other professionals with demanding construction and other professional applications.

LINK® AMERICAN HARDWOOD QUALITY LEVELS

21 Better quality American hardwood with a clear finish. Ideal for frequent heavy-duty use by farmers, ranchers, contractors and other professionals with demanding construction and other professional applications.

SUMMARY OF LINK® FINISHES AND QUALITY LEVELS

Quality Level #	Quality Level	Finish Type	Special Features	Govt. Specs	Suggested User
AMERICAN HICKORY					
01	Best	Sanded	Non-slip grip	A	Industrial, commercial
02	Best	Wax		A	Industrial, commercial
08	Better	Wax			Contractor, professional, homeowner
19	Better	Clear lacquer	Fire finish		Contractor, homeowner
AMERICAN HARDWOOD					
21	Better	Clear lacquer			Contractor, homeowner

Link® replacement handles allow today's consumer or professional contractor to get additional years of life out of trusted tools by replacing cracked, worn or broken handles. Handy merchandising units act as silent salesmen, guiding customers to the correct replacement.

THERE IS NO SUBSTITUTE FOR A GOOD DISPLAY

- Let customers know you carry common replacements.
- Illustrated display banner shows and tells which tools each handle fits.
- Simple plan makes every clerk an instant replacement handle expert.
- Makes selection easy for customers.
- Requires minimum space.
- Organized and neat.
- Strong and attractive rack.
- Available in 8 and 12 hook models.
- Available in wall or floor versions.
- Easily customized to your exact needs.
- Improves inventory control.
- Simplifies re-orders.
- Increases sales profits.



The wall mount displays can be used as floor displays by using the floor stands (ordered separately).

Model	Description
64026 / LINK8HD	8-hook display, pegboard wall mount, 24" wide
64021 / LINK12HD	12-hook display, pegboard wall mount, 24" wide
64027 / LINKFSD	Floor stand for wall mount displays

AXE AND BUSH HOOK HANDLES

SINGLE BIT CURVED GRIP AXE HANDLES

For 3 to 5 lb. axes and bush hooks, eye 2-5/16" x 3/4"



Model	Length	UPC 0 25545 +	Pack qty	Pack wgt	Pack cube
64698 / 100-01	36"	10001-5	12	18.0	0.92
64701 / 100-02	36"	10002-2	12	18.0	0.92
64703 / 100-08	36"	10008-4	12	18.0	0.92
64709 / 100-19	36"	10019-0	12	18.0	0.92
64889 / 102-02	32"	10202-6	12	15.0	0.92
64890 / 102-08	32"	10208-8	12	15.0	0.92
64894 / 102-19	32"	10219-4	12	15.0	0.92
64903 / 104-08	28"	10204-2	12	12.0	0.92

BOYS SINGLE BIT CURVED GRIP AXE HANDLES

For 2-1/4 lb. axes, eye 2-1/16" x 11/16"



Model	Length	UPC 0 25545 +	Pack qty	Pack wgt	Pack cube
64913 / 116-02	28"	11602-3	12	10.0	0.66
64914 / 116-08	28"	11608-5	12	10.0	0.66
64918 / 116-19	28"	11619-1	12	10.0	0.66

HOUSE CURVED GRIP AXE HANDLES

For 2-1/4 lb. axes, eye 2-1/16" x 11/16"



Model	Length	UPC 0 25545 +	Pack qty	Pack wgt	Pack cube
64927 / 118-19	18"	11819-5	12	8.0	0.60

STRAIGHT SINGLE BIT AXE HANDLES

For 3 to 5 lb. axes, eye 2" x 13/16"



Model	Length	UPC 0 25545 +	Pack qty	Pack wgt	Pack cube
64731 / 119-19	36"	11919-2	12	18.0	0.92

MINER'S STRAIGHT SINGLE BIT AXE HANDLES

For 3 to 5 lb. axes, eye 2" x 13/16"



Model	Length	UPC 0 25545 +	Pack qty	Pack wgt	Pack cube
64937 / 124-02	27"	12402-8	12	12.0	0.60
64939 / 124-19	27"	12419-6	12	12.0	0.60



ALL PRODUCTS ON THIS PAGE
ARE MADE IN THE USA (UNLESS NOTED)

DOUBLE BIT AXE HANDLES

For 3 to 5 lb. axes, some Pulaski axes, and #2 and #3 coal picks, eye 2-7/8" x 5/8"



Model	Length	UPC 0 25545 +	Pack qty	Pack wgt	Pack cube
64738 / 140-02	36"	14002-8	12	18.0	0.92
64740 / 140-08	36"	14008-0	12	18.0	0.92
64745 / 140-19	36"	14019-6	12	18.0	0.92
64941 / 142-19	32"	14219-0	12	15.0	0.92

CRUISER'S OR CEDAR DOUBLE BIT AXE HANDLES

For 2-1/2 lb. axes, eye 2-1/4" x 5/8"



Model	Length	UPC 0 25545 +	Pack qty	Pack wgt	Pack cube
64944 / 145-02	28"	14502-3	12	10.0	0.66
64945 / 145-08	28"	14508-5	12	10.0	0.66
64947 / 145-19	28"	14519-1	12	10.0	0.66

PICK, MATTOCK & GRUB HOE HANDLES

DOUBLE BIT GARDEN MATTOCK HANDLES

For 2-1/2 lb. mattocks, No. 10 eye 3" x 1"



Model	Length	UPC 0 25545 +	Pack qty	Pack wgt	Pack cube
64762 / 200-19	36"	20019-7	12	18.0	0.92

CURVED GRUB HOE HANDLES

For 3-1/2 to 5 lb. grub hoes, No. 8 eye 3" x 2"



Model	Length	UPC 0 25545 +	Pack qty	Pack wgt	Pack cube
65117 / 210-19	36"	21019-6	12	30.0	1.37

STRAIGHT GRUB HOE HANDLES

For 3-1/2 to 5 lb. grub hoes, No. 8 eye 3" x 2"



Model	Length	UPC 0 25545 +	Pack qty	Pack wgt	Pack cube
65121 / 214-19	36"	21419-4	12	30.0	1.37
65123 / 215-19	40"	21519-1	12	34.0	1.57



ALL PRODUCTS ON THIS PAGE ARE MADE IN THE USA (UNLESS NOTED)

PICK, MATTOCK & GRUB HOE HANDLES (cont.)

SMALL EYE GRUB HOE HANDLES

For 3 lb. grub hoes, No. 9 eye 2-1/2" x 1-7/8"



Model	Length	UPC 0 25545 +	Pack qty	Pack wgt	Pack cube
65119 / 213-19	40"	21319-7	12	32.0	1.66

RAILROAD OR CLAY PICK OR MATTOCK HANDLES

For 5 lb. and heavier picks and mattocks, No. 6 eye 3" x 2"



Model	Length	UPC 0 25545 +	Pack qty	Pack wgt	Pack cube
65030 / 220-01	36"	22001-0	12	30.0	1.37
65031 / 220-02	36"	22002-7	12	30.0	1.37
65035 / 220-08	36"	22008-9	12	30.0	1.37
63025 / 220-19	36"	22019-5	12	30.0	1.37

GARDEN OR NURSERY MATTOCK HANDLES

For 3 lb. mattocks, No. 7 eye 2-3/4" x 1-3/4"



Model	Length	UPC 0 25545 +	Pack qty	Pack wgt	Pack cube
65059 / 240-08	36"	24008-7	12	25.0	0.92
65060 / 240-19	36"	24019-3	12	25.0	0.92

MATTOCK HANDLE

For Laurel, Dig-Ezy, Southern Queen pattern mattocks, 1-1/2" round eye



Model	Length	UPC 0 25545 +	Pack qty	Pack wgt	Pack cube
66689 / 813-21	54"	81321-2	6	9.0	0.61

STRIKING TOOL HANDLES

SLEDGE OR MAUL HANDLES

Oval eye 1-1/4" x 1"



Model	Length	UPC 0 25545 +	Pack qty	Pack wgt	Pack cube
For 6 to 16 lb. sledge or striking hammers					
64403 / 001-01	36"	00101-5	12	18.0	0.74
64407 / 001-02	36"	00102-2	12	18.0	0.74
64412 / 001-08	36"	00108-4	12	18.0	0.74
64419 / 001-19	36"	00119-0	12	18.0	0.74
64536 / 002-01	32"	00201-2	12	16.0	0.60
64537 / 002-02	32"	00202-9	12	16.0	0.60
64538 / 002-08	32"	00208-1	12	16.0	0.60
64542 / 002-19	32"	00219-7	12	16.0	0.60

For 6 to 8 lb. sledge or striking hammers

64547 / 003-02	30"	00302-6	12	14.0	0.66
64549 / 003-08	30"	00308-8	12	14.0	0.66
64552 / 003-19	30"	00319-4	12	14.0	0.66
64558 / 004-01	24"	00401-6	12	10.0	0.60
64559 / 004-08	24"	00408-5	12	10.0	0.60
64563 / 004-19	24"	00419-1	12	10.0	0.60
64441 / 009-19	36"	00919-6	12	18.0	0.60

HEAVY AND EXTRA HEAVY SLEDGE HANDLES



Model	Length	UPC 0 25545 +	Pack qty	Pack wgt	Pack cube
For 18 to 24 lb. heavy sledges, eye 1-1/2" x 1-1/4"					
64645 / 010-02	36"	01002-4	12	20.0	0.92
64650 / 010-09	36"	01009-3	12	20.0	0.92
64652 / 010-19	36"	01019-2	12	20.0	0.92
64574 / 023-19	32"	02319-2	12	18.0	0.60
For extra heavy sledges, eye 1-3/4" x 1-1/4"					
64659 / 015-02	36"	01503-6	12	22.0	0.92
64662 / 015-19	36"	01519-7	12	22.0	0.92

STRAIGHT DOUBLE BIT EYE SPLITTING MAUL HANDLES

No. 5 eye 2-1/8" x 7/8"



Model	Length	UPC 0 25545 +	Pack qty	Pack wgt	Pack cube
64765 / 205-02	36"	20502-4	12	18.0	0.92
64767 / 205-08	36"	20508-6	12	18.0	0.92
64768 / 205-19	36"	20519-2	12	18.0	0.92

STRAIGHT SINGLE BIT EYE SPLITTING MAUL & BUSH HOOK HANDLES

Eye 2-5/16" x 13/16"



Model	Length	UPC 0 25545 +	Pack qty	Pack wgt	Pack cube
64772 / 206-02	36"	20602-1	12	18.0	0.92
64774 / 206-08	36"	20608-3	12	18.0	0.92
64777 / 206-19	36"	20619-9	12	18.0	0.92

STRIKING TOOL HANDLES (cont.)

CARPENTER'S ADZE HANDLES

For house or railroad carpenter's adze, eye 2-5/16" x 1-1/2"



Model	Length	UPC 0 25545 +	Pack qty	Pack wgt	Pack cube
65130 / 224-02	36"	22402-5	12	20.0	0.92
65132 / 224-19	36"	22419-3	12	20.0	0.92

POST MAUL HANDLES



Model	Length	UPC 0 25545 +	Pack qty	Pack wgt	Pack cube
For cast iron mauls, eye 2" x 1-7/16"					
65136 / 228-01	36"	22801-6	12	20.0	0.92
65138 / 228-19	36"	22819-1	12	20.0	0.92
For cast iron mauls, eye 2-1/4" x 1-11/16"					
65140 / 229-08	36"	22908-2	12	20.0	0.92
65141 / 229-19	36"	22919-8	12	20.0	0.92

DITCH BANK BLADE HANDLES

DITCH BANK BLADE HANDLES



Model	Length	UPC 0 25545 +	Pack qty	Pack wgt	Pack cube
For 4-hole blades					
65220 / 255-19	40"	25519-7	12	22.9	1.02
For 3-hole blades					
65227 / 260-08	40"	26008-5	12	22.8	1.02
65228 / 260-19	40"	26019-1	12	22.8	1.02
65236 / 262-19	36"	26219-5	12	21.9	0.92

CLAW HAMMER HANDLES

CLAW, RIPPING, NAIL HAMMER HANDLES



Model	Length	UPC 0 25545 +	Pack qty	Pack wgt	Pack cube
For 16 oz. hammers, eye 1-1/16" x 9/16"					
65382 / 300-02	14"	30002-6	12	5.0	0.20
65386 / 300-08	14"	30008-8	12	5.0	0.20
65392 / 300-19	14"	30019-4	12	5.0	0.20
For 16 oz. and some 20 oz. hammers, eye 1-1/16" x 9/16"					
65402 / 302-02	16"	30202-0	12	6.5	0.21



ALL PRODUCTS ON THIS PAGE
ARE MADE IN THE USA (UNLESS NOTED)

For 20, 22, and 24 oz. hammers, eye 1-1/16" x 5/8"

65412 / 310-02	14"	31002-5	12	5.0	0.18
65415 / 312-02	16"	31202-9	12	6.5	0.21
65417 / 312-08	16"	31208-1	12	6.5	0.21
65419 / 312-19	16"	31219-7	12	6.5	0.21
65424 / 313-19	18"	31319-4	12	7.0	0.25

For 28 to 32 oz. hammers, eye 1-3/16" x 3/4"

65426 / 321-02	16"	32102-1	12	6.5	0.33
65427 / 321-08	16"	32108-3	12	6.5	0.33
65428 / 321-19	16"	32119-9	12	6.5	0.33
65431 / 322-19	18"	32219-6	12	8.0	0.32

For 13 oz. hammers, eye 1" x 1/2"

65435 / 325-02	13"	32502-9	12	4.0	0.18
65437 / 325-08	13"	32508-1	12	4.0	0.18
65440 / 325-19	13"	32519-7	12	4.0	0.18

For 7 oz. hammers, eye 7/8" x 1/2"

65449 / 327-19	12"	32719-1	12	3.0	0.12
----------------	-----	---------	----	-----	------

CLAW, RIPPING, NAIL OCTAGON BODY HAMMER HANDLES

For octagon body, 16 oz. hammers, eye 1-1/16" x 9/16"



Model	Length	UPC 0 25545 +	Pack qty	Pack wgt	Pack cube
65406 / 304-02	14"	30402-4	12	5.0	0.18
65407 / 304-08	14"	30408-6	12	5.0	0.18
65409 / 304-19	14"	30419-2	12	5.0	0.18

BALL PEIN HAMMER HANDLES

BALL PEIN MACHINIST HAMMER HANDLES



Model	Length	UPC 0 25545 +	Pack qty	Pack wgt	Pack cube
For 2 oz. hammers, eye 7/16" x 1/4"					
65530 / 400-19	10"	40019-1	12	2.0	0.12
For 4 to 6 oz. hammers, eye 9/16" x 5/16"					
65535 / 401-19	10"	40119-8	12	2.5	0.12
For 8 to 12 oz. hammers, eye 3/4" x 7/16"					
65539 / 403-02	12"	40302-4	12	3.0	0.12
65544 / 403-08	12"	40308-6	12	3.0	0.12
65548 / 403-19	12"	40319-2	12	3.0	0.12
For 16 to 20 oz. hammers, 29/32" x 17/32"					
65559 / 405-02	14"	40502-8	12	4.0	0.18
65562 / 405-08	14"	40508-0	12	4.0	0.18
65569 / 405-19	14"	40519-6	12	4.0	0.18



ALL PRODUCTS ON THIS PAGE ARE MADE IN THE USA (UNLESS NOTED)

BALL PEIN HAMMER HANDLES (cont.)

For 24 to 28 oz. hammers, 1-1/16" x 19/32"

65578 / 407-02	16"	40702-2	12	5.0	0.21
65581 / 407-08	16"	40708-4	12	5.0	0.21
65586 / 407-19	16"	40719-0	12	5.0	0.21

For 32 to 48 oz. hammers, eye 1-3/16" x 11/16"

65592 / 409-02	18"	40902-6	12	6.0	0.25
65594 / 409-08	18"	40908-8	12	6.0	0.25
65598 / 409-19	18"	40919-4	12	6.0	0.25

TIRE HAMMER HANDLES

TIRE HAMMER HANDLES FOR KEN TOOL HAMMERS



Model	Length	UPC 0 25545 +	Pack qty	Pack wgt	Pack cube
-------	--------	---------------	----------	----------	-----------

Ringed Grip for T11, T11C, T34, T35 and T36, Eye - 1.8125" x 1.9375" - Clear Lacquer Fire Finish

65367 / 477-19	30"	47719-3	12	20.4	0.54
----------------	-----	---------	----	------	------



Non-slip grip, for T11, T11C, T34, T35, and T36 eye 1-3/16" x 1-5/16"

65361 / 474-55	17"	47455-0	12	10.0	0.31
65365 / 477-55	30"	47755-1	12	20.0	0.54

SHORT SLEDGE AND OTHER HAMMER HANDLES

ENGINEER'S HAMMER HANDLES, OVAL EYE



Model	Length	UPC 0 25545 +	Pack qty	Pack wgt	Pack cube
-------	--------	---------------	----------	----------	-----------

For 1-1/2 to 2-1/2 lb. hammers, eye 7/8" x 5/8"

65768 / 435-19	12"	43519-3	12	4.0	0.18
65697 / 421-02	14"	42102-8	12	4.0	0.22
65701 / 421-19	14"	42119-6	12	4.0	0.22

For 3 to 4 lb. hammers, eye 1" x 3/4"

65710 / 423-01	16"	42301-5	12	5.0	0.21
65711 / 423-02	16"	42302-2	12	5.0	0.21
65714 / 423-08	16"	42308-4	12	5.0	0.21
65720 / 423-19	16"	42319-0	12	5.0	0.21

For 3 to 4 lb. hammers, eye 1" x 3/4"

65737 / 424-19	18"	42419-7	12	6.0	0.25
----------------	-----	---------	----	-----	------

BLACKSMITH HAMMER HANDLES, FLAT EYE

For 2 to 3 lb. hammers, eye 1-3/16" x 11/16"



Model	Length	UPC 0 25545 +	Pack qty	Pack wgt	Pack cube
65741 / 430-01	14"	43001-3	12	4.5	0.23
65742 / 430-02	14"	43002-0	12	4.5	0.23
65744 / 430-08	14"	43008-2	12	4.5	0.23
65746 / 430-19	14"	43019-8	12	4.5	0.23

For 3.5 lb. and heavier hammers, eye 1-1/4" x 1"

65748 / 432-02	16"	43202-4	12	6.0	0.30
65751 / 432-19	16"	43219-2	12	6.0	0.30

For 3.5 lb. and heavier hammers, eye 1-1/4" x 1"

65758 / 433-02	18"	43302-1	12	7.0	0.33
65760 / 433-08	18"	43308-3	12	7.0	0.33
65764 / 433-19	18"	43319-9	12	7.0	0.33

BRICK HAMMER HANDLES

For brick hammers and scutches, eye 1-1/16" x 19/32"



Model	Length	UPC 0 25545 +	Pack qty	Pack wgt	Pack cube
65782 / 440-19	12"	44019-7	12	5.0	0.18

STONE MASON HAMMER HANDLES

Oval eye 1-1/8" x 5/8"



Model	Length	UPC 0 25545 +	Pack qty	Pack wgt	Pack cube
65868 / 451-19	16"	45119-3	12	5.5	0.28

HAND DRILL AND SLEDGE HAMMER HANDLES

For 2 to 4 lb. hammers, oval eye 1" x 3/4"



Model	Length	UPC 0 25545 +	Pack qty	Pack wgt	Pack cube
65993 / 480-02	10-1/2"	48002-5	12	5.0	0.23
65994 / 480-19	10-1/2"	48019-3	12	5.0	0.23
66004 / 481-19	12"	48119-0	12	6.0	0.21

SHORT SLEDGE AND OTHER HAMMER HANDLES (cont.)

STRAIGHT CALIFORNIA FRAMING HAMMER HANDLES



Model	Length	UPC 0 25545 +	Pack qty	Pack wgt	Pack cube
For 23 oz. Hart hammers, eye 1-5/8" x 11/16"					
65898 / 1172-02	18"	00643-3	12	6.0	0.33
For 23 oz. Vaughn & Bushnell hammers, eye 1-11/16" x 11/16"					
65902 / 6321-19	18"	03957-5	12	6.0	0.33

CURVED CALIFORNIA FRAMING HAMMER HANDLES

For 25 oz. hammers, eye 1-11/16" x 11/16"



Model	Length	UPC 0 25545 +	Pack qty	Pack wgt	Pack cube
65905 / 7078-19	18"	06493-5	12	7.0	0.33

HATCHET HANDLES

HATCHET HANDLES



Model	Length	UPC 0 25545 +	Pack qty	Pack wgt	Pack cube
For No. 2 shingling, half-hatchet, claw, and No. 1 broad hatchets, eye 1-19/32" x 19/32"					
65273 / 330-02	14"	33002-3	12	6.0	0.23
65275 / 330-08	14"	33008-5	12	6.0	0.23
65278 / 330-19	14"	33019-1	12	6.0	0.23
For No. 3 and 4 broad hatchets and linesman's hatchets, eye 1-13/16" x 5/8"					
65285 / 334-19	16"	33419-9	12	8.0	0.28

PLUMB EXPERT HATCHET HANDLES

For plumb, box, wallboard, and California lathe hatchets eye 1-1/4" x 1/2"



Model	Length	UPC 0 25545 +	Pack qty	Pack wgt	Pack cube
65288 / 350-02	14"	35002-1	12	5.0	0.23
65289 / 350-19	14"	35019-9	12	5.0	0.23



ALL PRODUCTS ON THIS PAGE ARE MADE IN THE USA (UNLESS NOTED)

RIG BUILDER'S (RIGSTER) HATCHET HANDLES

For rig hatchets, eye 1-9/16" x 5/8"



Model	Length	UPC 0 25545 +	Pack qty	Pack wgt	Pack cube
65292 / 365-02	18"	36502-5	12	7.0	0.33
65293 / 365-19	18"	36519-3	12	7.0	0.33

BOY SCOUT AXE HANDLES



Model	Length	UPC 0 25545 +	Pack qty	Pack wgt	Pack cube
For 1-1/4 lb. axes, eye 1-5/8" x 19/32"					
65295 / 368-02	14"	36802-6	12	6.0	0.28
65297 / 368-08	14"	36808-8	12	6.0	0.28
65300 / 368-19	14"	36819-4	12	6.0	0.28
For 1-3/4 lb. axes, 1-3/4" x 11/16"					
65309 / 369-19	16"	36919-1	12	7.0	0.33

FILE HANDLES

LONG FERRULE FILE HANDLES



Model	Length	UPC 0 25545 +	Pack qty	Pack wgt	Pack cube
4" x 1" (size No. 1) for 3" to 6" files					
64223 / 29541-00	4"	00018-6	36	2.0	0.06
4-1/2" x 1-3/16" (size No. 2) for 6" to 8" files					
64224 / 29542-00	4-1/2"	00019-3	36	4.0	0.10
5" x 1-5/16" (size No. 3) for 8" to 12" files					
64225 / 29543-00	5"	00020-9	36	5.3	0.12
5-1/2" x 1-7/16" (size No. 4) for 12" to 16" files					
64227 / 29544-00	5-1/2"	00021-6	36	7.0	0.18
6" x 1-9/16" (size No. 5) for 16" to 20" files					
64229 / 29545-00	6"	00022-3	36	9.0	0.21



ALL PRODUCTS ON THIS PAGE ARE MADE IN THE USA (UNLESS NOTED)

FILE HANDLES (cont.)

SHORT FERRULE FILE HANDLES



Model	Length	UPC 0 25545 +	Pack qty	Pack wgt	Pack cube
3-1/2" x 13/16" (size No. 00), bore 1/8", for chain saws					
64240 / 31559-00	3-1/2"	00024-7	36	1.5	0.12
3-1/2" x 13/16" (size No. 01), bore 5/32", for 3" to 4" files					
64241 / 31561-00	3-1/2"	00025-4	36	1.5	0.12
4" x 15/16" (size No. 02), bore 3/16", for 4" to 6" files					
64242 / 31562-00	4"	00026-1	36	2.0	0.09
4-1/4" x 1-3/64" (size No. 03), bore 7/32", for 6" to 8" files					
64243 / 31563-00	4-1/4"	00027-8	36	2.5	0.12
4-3/4" x 1-1/8" (size No. 04), bore 9/32", for 8" to 10" files					
64244 / 31564-00	4-3/4"	00028-5	36	3.5	0.15
5" x 1-1/4" (size No. 05), bore 3/8", for 10" to 14" files					
64245 / 31565-00	5"	00029-2	36	4.0	0.14

TITEGRIP SCREW-ON FILE HANDLES

A screw on handle that makes its own thread on tang of file



Model	Length	UPC 0 25545 +	Pack qty	Pack wgt	Pack cube
For 4" files					
64232 / 30571-00		00032-2	36	1.5	0.05
For 5" files					
64234 / 30572-00		00033-9	36	3.0	0.09
For 6" files					
64231 / 30569-00		00034-6	36	3.0	0.07
For 8" files					
64235 / 30573-00		00035-3	36	5.0	0.13
For 10" files					
64236 / 30574-00		00036-0	36	5.0	0.13
For 12" files and rasps					
64238 / 30576-00		00037-7	36	7.3	0.19
For 14" files and rasps					
64237 / 30575-00		00038-4	36	7.3	0.19

NO. 10 FILE CARD

The sharp steel bristles quickly remove filings from file grooves



Model	Length	UPC 0 25545 +	Pack qty	Pack wgt	Pack cube
64246 / 324-00	8"	32400-8	12	2.0	0.07

HANDLE WEDGES

WOOD AND STEEL WEDGES

Each package contains 1 wood wedge and 2 steel wedges. Color coded for display. Includes step-by-step instructions and diagrams.



Model	Color	UPC 0 25545 +	Pack qty	Pack wgt	Pack cube
Hammer handle wedges					
64128 / 04510-00	Blue	00001-8	24	1.3	0.12
Hatchet handle wedges					
64131 / 04511-00	Green	00002-5	24	1.3	0.12
Sledge and maul handle wedges					
64133 / 04512-00	Red	00003-2	24	1.5	0.12
Axe handle wedges					
64136 / 04513-00	Brown	00004-9	24	2.0	0.12
Boxed assortment with 24 wood and steel wedges (6 each of all sizes)					
64139 / 04514-00		00005-6	1	1.8	

CORRUGATED STEEL WEDGES



Model	Package wgt	UPC 0 25545 +	Pack qty	Pack wgt	Pack cube
Hammer handle wedges, No. 2, 5/16" W x 13/16" H, 36 per package					
64144 / 50-490	3 oz.	00006-3	1	0.2	0.07
Carpenter's hammer handle wedges, No. 3, 1/2" W x 1-1/16" H, 36 per package					
64145 / 50-491	9 oz.	00007-0	1	0.6	0.07
Large hammer handle wedges, No. 4, 3/4" W x 1-1/16" H, 36 per package					
64146 / 50-492	10 oz.	00008-7	1	0.6	0.07
Sledge hammer handle wedges, No. 5, 1" W x 1-1/16" H, 36 per package					
64147 / 50-493	12 oz.	00009-4	1	0.8	0.07
Axe handle wedges, No. 18, 1-1/4" W x 1-3/16" H, 12 per package					
64148 / 50-494	10 oz.	00010-0	1	0.6	0.07

HANDLE WEDGES (cont.)

STEEL WEDGE AND RIVET ASSORTMENT IN COUNTER DISPLAY



Assortment includes 252 pieces plus display box. Contains 12 LR1 and 12 LR2 round wedges; 36 #2, 36 #3, 36 #4, 36 #5, and 12 #18 flat steel wedges; plus 72 rivets.

Model	UPC 0 25545 +	Pack qty	Pack wgt	Pack cube
64149 / 50-497	00011-7	1	3.0	0.07

WOOD WEDGES

Each package contains 12 wood wedges. Includes step-by-step instructions and diagrams.



Model	Package wgt	UPC 0 25545 +	Pack qty	Pack wgt	Pack cube
Single bit axe handle wedges, No. 2WW, 2-1/2" W x 2-1/2" H					
64151 / 13-390	5.0	00012-4	12	2.1	0.18
Sledge handle wedges, No. 3WW, 1-3/8" W x 2-1/2" H					
64153 / 13-391	2.7	00013-1	12	1.3	0.18
Machinist hammer handle wedges, No. 4WW, 1-1/16" W x 1-1/2" H					
64155 / 13-392	0.8	00014-8	12	0.5	0.08
Hatchet handle wedges, No. 8WW, 1-5/8" W x 2" H					
64157 / 13-393	3.4	00015-5	12	1.6	0.18
Double bit axe handle wedges, No. 9WW, 3" W x 2-1/2" H					
64158 / 13-394	5.5	00016-2	12	2.5	0.18
Nail hammer handle wedges, No. 10WW, 1-3/16" W x 1-1/2" H					
64159 / 13-395	0.8	00017-9	12	0.5	0.08



ALL PRODUCTS ON THIS PAGE
ARE MADE IN THE USA (UNLESS NOTED)

ROUND (CONE-SHAPED) STEEL WEDGES

- Expands wood equally in all directions for tightest fit.
- Provides better holding power than flat wedges.
- Eliminates need for flat wood and steel wedges.
- Two sizes fit every need.

Contoured top rim helps keep wedge in place

Beveled bottom rim shears wood fibers and compresses them toward the center

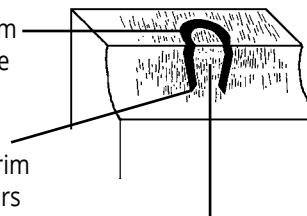

Wood expands into interior of wedge to create a secure and safe grip



ROUND STEEL WEDGES, RETAIL PACK

Each retail package contains 2 round steel wedges. Includes step-by-step instructions and diagrams.



Model	Package wgt	UPC 0 25545 +	Pack qty	Pack wgt	Pack cube
LR1 round steel wedges, 9/16" H x 9/16" diameter					
64140 / 06903-00	0.7	06903-9	6	0.5	0.08
LR2 round steel wedges, 3/4" H x 3/4" diameter					
64142 / 06905-00	1.1	16905-0	6	0.6	0.08

ROUND STEEL WEDGES, BULK PACK

Each bulk package contains 12 round steel wedges.



Model	Package wgt	UPC 0 25545 +	Pack qty	Pack wgt	Pack cube
LR1 round steel wedges, 9/16" H x 9/16" diameter					
64141 / 06904-00	3.7	16904-3	12	1.5	0.05
LR2 round steel wedges, 3/4" H x 3/4" diameter					
64143 / 06906-00	6.1	16906-7	12	2.4	0.05

HEAVY-DUTY FIBERGLASS HANDLES

SLEDGE AND MAUL FIBERGLASS HANDLE

001 is for 6 to 16 lb. and some 18 to 24 lb. sledges and mauls. 010 is for heavy sledges. Handle comes with epoxy kit.



Model	Length	UPC 0 25545 +	Pack qty	Pack wgt	Pack cube
64430 / 001-99	34"	00199-2	6	13.0	0.74
64657 / 010-99	36"	01099-4	6	15.6	0.85

SINGLE BIT AXE FIBERGLASS HANDLE

For 3 to 5 lb. single bit axes. Handle comes with epoxy kit.



Model	Length	UPC 0 25545 +	Pack qty	Pack wgt	Pack cube
64718 / 100-99	34"	10099-2	6	14.0	0.92

DOUBLE BIT AXE FIBERGLASS HANDLE

For 3 to 5 lb. double bit axes. Handle comes with epoxy kit.



Model	Length	UPC 0 25545 +	Pack qty	Pack wgt	Pack cube
64749 / 140-99	34"	06932-9	6	14.0	0.92

RAILROAD AND GARDEN PICK FIBERGLASS HANDLE

220 is for railroad No. 6 eye picks and mattocks. 200 is for 2.5 lb. mattocks with #10 eye. Centrifugal force tightens head so no epoxy needed. 221 is for 2.5 lb. mattocks with 2-1/4"x 1-1/2" slip eye.



Model	Length	UPC 0 25545 +	Pack qty	Pack wgt	Pack cube
64764 / 200-99	36"	20099-9	6	14.6	1.20
65053 / 220-99	36"	06933-6	6	16.0	1.37
65057 / 221-99	36"	22199-4	6	16.0	1.30

CLAW HAMMER FIBERGLASS HANDLE

Handle comes with epoxy kit.



Model	Length	UPC 0 25545 +	Pack qty	Pack wgt	Pack cube
65399 / 300-99	14"	06929-9	6	4.0	0.20

ENGINEER'S AND BLACKSMITH'S HAMMER FIBERGLASS HANDLE

Handle comes with epoxy kit.



Model	Length	UPC 0 25545 +	Pack qty	Pack wgt	Pack cube
65725 / 423-99	15"	42399-2	6	7.0	0.20
65998 / 480-99	10.5"	48099-5	6	2.6	0.15

SHOVEL FIBERGLASS HANDLE

For hollowback and closed back shovels. Handle comes with rivet.



Model	Length	UPC 0 25545 +	Pack qty	Pack wgt	Pack cube
66770 / 870-99	46"	06940-4	6	14.0	0.53

D-GRIP SHOVEL FIBERGLASS HANDLE

For D-grip hollowback and closed back shovels. Handle comes with rivet.

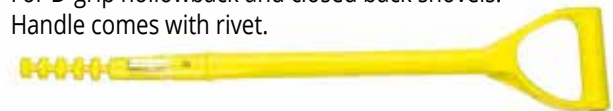

Model	Length	UPC 0 25545 +	Pack qty	Pack wgt	Pack cube
66776 / 871-99	27"	06931-2	6	10.0	0.68

EPOXY KIT

For attaching fiberglass handles



Model	Length	UPC 0 25545 +	Pack qty	Pack wgt	Pack cube
64112 / 7001-00		04033-5	6	2.00	.11

FORK HANDLES

STRAIGHT HAY FORK HANDLES

1-7/16" diameter, 7/16" bore, 8" ferrule



Model	Length	UPC 0 25545 +	Pack qty	Pack wgt	Pack cube
66560 / 700-21	48"	70021-5	6	11	0.53
66561 / 701-21	54"	70121-2	6	12	0.51

BENT HAY, 3-TINE HEADER, AND ALFALFA FORK HANDLES

1-7/16" diameter, 7/16" bore, 8" ferrule



Model	Length	UPC 0 25545 +	Pack qty	Pack wgt	Pack cube
66564 / 706-21	48"	70621-7	6	11	0.53
66566 / 707-21	54"	70721-4	6	12	0.61
66568 / 708-21	60"	70821-1	6	14	0.55

BENT MANURE AND BARLEY FORK HANDLES

1-7/16" diameter, 1/2" bore, 8" ferrule



Model	Length	UPC 0 25545 +	Pack qty	Pack wgt	Pack cube
66575 / 715-21	48"	71521-9	6	11	0.53
66580 / 716-21	54"	71621-6	6	12	0.61
66585 / 717-21	60"	71721-3	6	13	0.55

BENT SPADING FORK HANDLES

1-1/2" diameter, 5/8" bore, 8" ferrule



Model	Length	UPC 0 25545 +	Pack qty	Pack wgt	Pack cube
66570 / 711-21	48"	71121-1	6	13	0.53
66806 / 922-21	54"	92221-1	6	14	0.61

BENT SPADING FORK HANDLE, STEEL D-GRIP

1-1/2" diameter, 5/8" bore, 8" ferrule

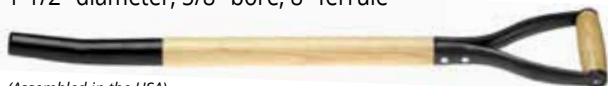

(Assembled in the USA)

Model	Length	UPC 0 25545 +	Pack qty	Pack wgt	Pack cube
66595 / 730-21	30"	73021-2	6	13	0.68



ALL PRODUCTS ON THIS PAGE
ARE MADE IN THE USA (UNLESS NOTED)

BENT MANURE FORK, CLAM FORK, BARLEY FORK, AND SOD LIFTER HANDLES, STEEL D-GRIP



(Assembled in the USA)

Model	Length	UPC 0 25545 +	Pack qty	Pack wgt	Pack cube
1-1/2" diameter, 1/2" bore x 3", 8" ferrule					
66599 / 731-21	32"	73121-9	6	13	0.68
1-1/2" diameter, 5/8" bore x 3", 8" ferrule					
66601 / 736-21	36"	73621-4	6	14	0.68

BENT SEED, COKE, ENSILAGE, AND HEAVY MANURE FORK HANDLES, STEEL D-GRIP

1-1/2" diameter, 11/16" bore, 8" ferrule



(Assembled in the USA)

Model	Length	UPC 0 25545 +	Pack qty	Pack wgt	Pack cube
66592 / 728-21	30"	72821-9	6	13	0.68
66600 / 734-21	32"	73421-0	6	14	0.68

HOE & HOOK HANDLES

EYE HOE AND FIRE RAKE HANDLE

1-3/4" round eye



Model	Length	UPC 0 25545 +	Pack qty	Pack wgt	Pack cube
66678 / 810-21	54"	81021-1	6	11	0.77
66682 / 811-21	60"	81121-8	6	12	0.86
63001	60"		3	6	0.44

POTATO HOOK HANDLES

1-7/16" diameter, 1/2" bore, 4" ferrule



Model	Length	UPC 0 25545 +	Pack qty	Pack wgt	Pack cube
66826 / 977-21	48"	97721-1	6	10	0.55
66827 / 978-21	54"	97821-8	6	11	0.61

ITALIAN GRAPE HOE HANDLES

2" x 1-5/8" diameter, oval shaped



Model	Length	UPC 0 31365 +	Pack qty	Pack wgt	Pack cube
63011	40"	01006-9	3	6.2	0.35



ALL PRODUCTS ON THIS PAGE ARE MADE IN THE USA (UNLESS NOTED)

HOE & HOOK HANDLES (cont.)

GARDEN HOE HANDLES

1-1/4" diameter, 3/8" bore, 4" ferrule. Also used for meadow hoes, light cotton hoes, light scuffle hoes, light hooks, stone hooks, and light potato hooks.

Model	Length	UPC 0 25545 +	Pack qty	Pack wgt	Pack cube
66607 / 741-21	48"	74121-8	6	8	0.98
66611 / 742-21	52"	74221-5	6	8	0.50
66615 / 743-21	54"	74321-2	6	9	0.50
66618 / 744-21	60"	74421-9	6	9	0.55

GARDEN HOE, MEADOW HOE, LIGHT COTTON HOE HANDLES

1-1/4" diameter, 3/8" bore, chucked

Model	Length	UPC 0 25545 +	Pack qty	Pack wgt	Pack cube
66621 / 746-21	52"	74621-3	6	8	0.50
66623 / 747-21	54"	74721-0	6	8	0.50
66627 / 748-21	60"	74821-7	6	9	0.55

SOCKET PATTERN HOE HANDLES

1-1/4" diameter, chucked

Model	Length	UPC 0 25545 +	Pack qty	Pack wgt	Pack cube
66639 / 756-21	52"	75621-2	6	8	0.50
66643 / 757-21	54"	75721-9	6	8	0.50
66644 / 758-21	60"	75821-6	6	9	0.55

HEAVY COTTON HOE AND SCRAPER HANDLES, WITH FERRULES

1-3/8" diameter, 7/16" bore, chucked, 4" ferrule

Model	Length	UPC 0 25545 +	Pack qty	Pack wgt	Pack cube
66631 / 752-21	54"	75221-4	6	9	0.50
66635 / 753-21	60"	75321-1	6	11	0.55

HEAVY COTTON HOE HANDLE, WITHOUT FERRULE

1-3/8" diameter, 7/16" bore, chucked, no ferrule

Model	Length	UPC 0 25545 +	Pack qty	Pack wgt	Pack cube
66646 / 760-21	54"	76021-9	6	8	0.50

PLANTER'S HOE HANDLE

1-7/16" diameter, 9/16" bore, 4" ferrule

Model	Length	UPC 0 25545 +	Pack qty	Pack wgt	Pack cube
66603 / 739-21	60"	73921-5	6	11	0.55

MORTAR HOE, SCUFFLE HOE, HEAVY HOOK, ROAD RAKE, ASPHALT RAKE, TAR RAKE, ETC. HANDLE

1-7/16" diameter, 9/16" bore, chucked, 8" ferrule

Model	Length	UPC 0 25545 +	Pack qty	Pack wgt	Pack cube
66647 / 765-21	60"	76521-4	6	15	0.55
66649 / 767-21	72"	76721-8	6	17	0.55

HEAVY SOCKET COTTON HOE & SIDEWALK SCRAPER HANDLE

1-3/8" diameter, chucked

Model	Length	UPC 0 25545 +	Pack qty	Pack wgt	Pack cube
66807 / 924-21	60"	92421-5	6	10	0.55

RAKE HANDLES

LAWN AND LEAF RAKE HANDLES

15/16" diameter, 2-1/2" chuck to 5/8"

Model	Length	UPC 0 25545 +	Pack qty	Pack wgt	Pack cube
66454 / 22-342	42"	05385-4	6	5	0.98
66455 / 22-348	48"	04806-5	6	6	0.98
66460 / 22-351	51"	04803-4	6	6	0.29
66464 / 22-360	60"	05095-2	6	7	0.86

LAWN AND LEAF RAKE HANDLES

15/16" diameter, straight end, 9/32" cross drill 1-5/8" from end

Model	Length	UPC 0 25545 +	Pack qty	Pack wgt	Pack cube
66491 / 22-604	54"	05240-6	12	11.2	1.06

RAKE HANDLES (Assembled in the USA)

LEVEL HEAD RAKE AND GARDEN HOE HANDLE

1-1/4" diameter, 3/8" bore, 4" ferrule



Model	Length	UPC 0 25545 +	Pack qty	Pack wgt	Pack cube
66656 / 790-21	60"	79021-6	6	10	0.55

LEVEL HEAD RAKE HANDLE

1-1/4" diameter, 3/8" bore, chucked



Model	Length	UPC 0 25545 +	Pack qty	Pack wgt	Pack cube
66664 / 794-21	60"	79421-4	6	9	0.55

BOW RAKE HANDLE

1-1/4" diameter, 4" ferrule, 7/16" bore



Model	Length	UPC 0 25545 +	Pack qty	Pack wgt	Pack cube
66668 / 797-21	60"	79721-5	6	10	0.55

SCRAPER HANDLES

SIDEWALK SCRAPER HANDLE

1-3/8" socket style, 3-7/8" chuck



Model	Length	UPC 0 25545 +	Pack qty	Pack wgt	Pack cube
66802 / 905-21	48"	90521-4	6	9	0.53

BARN SCRAPER HANDLE

1-7/16" diameter, 7/16" bore, 8" ferrule



Model	Length	UPC 0 25545 +	Pack qty	Pack wgt	Pack cube
66808 / 930-21	60"	93021-6	6	15	0.86

AUGER, DRAIN TILE AND POST HOLE DIGGER HANDLES

AUGER HANDLE

For augers with cross T handles



Model	Length	UPC 0 25545 +	Pack qty	Pack wgt	Pack cube
66427 / 22-027	21"	04848-5	6	2	0.68



ALL PRODUCTS ON THIS PAGE
ARE MADE IN THE USA (UNLESS NOTED)

DRAIN TILE CLEANER HANDLE

For all size drain cleaners



Model	Length	UPC 0 25545 +	Pack qty	Pack wgt	Pack cube
66430 / 22-076	72"	04877-5	6	2	0.95

SQUARE EYE POST HOLE DIGGER HANDLES

For Atlas, Hercules, and similar post hole diggers, drilled



Model	Length	UPC 0 25545 +	Pack qty	Pack wgt	Pack cube
66745 / 863-21	48"	86321-7	6	10	0.53
66761 / 866-21	72"	86621-8	6	17	0.95
66763 / 867-21	96"	86721-5	6	20	0.76

ROUND END POST HOLE DIGGER HANDLES

Drilled



Model	Length	UPC 0 25545 +	Pack qty	Pack wgt	Pack cube
66754 / 864-21	48"	86421-4	6	10	0.53

POST HOLE DIGGER HANDLES

For Eureka post hole diggers



Model	Length	UPC 0 25545 +	Pack qty	Pack wgt	Pack cube
66759 / 865-21	48"	86521-1	6	10	0.53

PRUNING TOOL HANDLES

HEDGE SHEAR HANDLES

21/32" bore, ferruled



(Assembled in the USA)

Model	Length	UPC 0 25545 +	Pack qty	Pack wgt	Pack cube
66425 / 22-023	10"	04845-4	6	2	1.18

LOPPING SHEAR HANDLES

4" ferrule, 1/2" bore



Model	Length	UPC 0 25545 +	Pack qty	Pack wgt	Pack cube
66428 / 22-033	24"	04854-6	6	5	1.18



ALL PRODUCTS ON THIS PAGE ARE MADE IN THE USA (UNLESS NOTED)

WHEELBARROW HANDLES & WEDGES

WHEELBARROW HANDLES

Model	Length	UPC 0 25545 +	Pack qty	Pack wgt	Pack cube
1-3/8" x 1-3/4", straight pattern, parallel end to end, shaped grip end, clear finish					
66534 / 35-025	60"	04769-3	6	27	0.86
1-3/8" x 1-3/4", straight pattern, parallel end to end, shaped grip end, sand finish					
66545 / 36-025	60"	04771-6	6	27	0.86
1-3/8" x 1-3/4", straight pattern, parallel end to end, shaped grip end, no bore, sand finish, homeowner quality					
66542 / 35-029	54"	05473-8	6	23	1.06

WHEELBARROW WEDGES, CLEAR FINISH

Model	Length	UPC 0 25545 +	Pack qty	Pack wgt	Pack cube
66539 / 35-026	22"	04770-9	6	5	1.18

PAINT ROLLER, SQUEEGEE, AND PUSH BROOM HANDLES

PUSH BROOM AND SQUEEGEE HANDLES, TAPERED END

1-1/8" diameter, tapered to 3/4" within 3"

Model	Length	UPC 0 25545 +	Pack qty	Pack wgt	Pack cube
66439 / 22-245	54"	04809-6	12	11	0.86
66441 / 22-250	60"	04810-2	12	15	0.86

PUSH BROOM HANDLES, METAL THREAD

15/16" diameter, 3/4" Acme metal thread

(Assembled in the USA)

Model	Length	UPC 0 25545 +	Pack qty	Pack wgt	Pack cube
66446 / 22-299	54"	05042-6	12	13	1.06
66448 / 22-300	60"	04802-7	12	15	0.55

PUSH BROOM HANDLES, WOOD THREAD

15/16" diameter, 3/4" Acme wood thread

(Assembled in the USA)

Model	Length	UPC 0 25545 +	Pack qty	Pack wgt	Pack cube
66459 / 22-350	60"	04811-9	12	14	0.86

WEED CUTTER HANDLES

WEED CUTTER HANDLE

Model	Length	UPC 0 25545 +	Pack qty	Pack wgt	Pack cube
65163 / 7248-00	30"	04123-3	12	15	1.18

TURF EDGER HANDLE

Model	Length	UPC 0 25545 +	Pack qty	Pack wgt	Pack cube
66426 / 22-025	48"	04846-1	12	12	0.53

TAMPER HANDLES

SHAPED TAMPER HANDLE

1-7/16" diameter, straight eye, sanded finish

Model	Length	UPC 0 25545 +	Pack qty	Pack wgt	Pack cube
66547 / 39652-21	44"	00582-2	6	2.5	0.53

UNSHAPED TAMPER HANDLE

1-1/2" diameter, straight eye, sanded finish

Model	Length	UPC 0 25545 +	Pack qty	Pack wgt	Pack cube
No slot					
66548 / 39658-21	48"	00588-4	6	1.8	0.53
66549 / 39659-21	42"	00589-1	6	1.5	0.53
With single 2" slot; wedge included					
66554 / 49658-21	48"	00852-6	6	1.8	0.53
66555 / 49659-21	42"	05851-4	6	1.5	0.53

BENT HOLLOWBACK SHOVEL HANDLES WITH SHOULDER

LONG BENT HOLLOWBACK SHOVEL/SCOOP HANDLES WITH SHOULDER

1-1/2" diameter, 9" chuck with slot

Model	Length	UPC 0 25545 +	Pack qty	Pack wgt	Pack cube
66705 / 827-21	48"	82721-9	6	10	0.53
66713 / 828-21	54"	82821-6	6	12	0.61

BENT HOLLOWBACK SHOVEL HANDLES WITH SHOULDER (cont..)

BENT HOLLOWBACK SHOVEL/SCOOP HANDLES WITH SHOULDER, STEEL D-GRIP

1-1/2" diameter, 9" chuck with slot



(Assembled in the USA)

Model	Length	UPC 0 25545 +	Pack qty	Pack wgt	Pack cube
66717 / 829-21	30"	82921-3	6	10	0.68
66823 / 960-21	36"	96021-3	6	12	0.53
66794 / 892-21	38"	89221-7	6	12	0.53
66781 / 876-21	42"	87621-7	6	13	0.53

BENT HOLLOWBACK SHOVEL HANDLES WITHOUT SHOULDER

LONG BENT HOLLOWBACK SHOVEL/SCOOP HANDLES WITHOUT SHOULDER

1-1/2" diameter, 9-1/2" eye chuck, eye slot



Model	Length	UPC 0 25545 +	Pack qty	Pack wgt	Pack cube
66694 / 823-21	48"	82321-1	6	10	0.53
66700 / 824-21	54"	82421-8	6	12	0.61

BENT HOLLOWBACK SHOVEL HANDLES WITHOUT SHOULDER, STEEL D-GRIP

1-1/2" diameter, 9-1/2" eye chuck, eye slot



(Assembled in the USA)

Model	Length	UPC 0 25545 +	Pack qty	Pack wgt	Pack cube
66702 / 825-21	30"	82521-5	6	10	0.68

STRAIGHT HOLLOWBACK SHOVEL HANDLES WITH SHOULDER

LONG STRAIGHT HOLLOWBACK FLORAL SHOVEL HANDLES WITH SHOULDER

1-7/16" diameter, 9" chuck with slot



Model	Length	UPC 0 25545 +	Pack qty	Pack wgt	Pack cube
66628 / 750-21	42"	75021-0	6	7	0.53



ALL PRODUCTS ON THIS PAGE
ARE MADE IN THE USA (UNLESS NOTED)

LONG STRAIGHT HOLLOWBACK SHOVEL/SCOOP HANDLES WITH SHOULDER

1-1/2" diameter, 9" chuck with slot



Model	Length	UPC 0 25545 +	Pack qty	Pack wgt	Pack cube
66766 / 870-21	48"	87021-5	6	10	0.53
66784 / 880-21	54"	88021-4	6	11	0.61

STRAIGHT HOLLOWBACK SHOVEL/SCOOP HANDLES WITH SHOULDER, STEEL D-GRIP

1-1/2" diameter, 9" chuck with slot



(Assembled in the USA)

Model	Length	UPC 0 25545 +	Pack qty	Pack wgt	Pack cube
66773 / 871-21	30"	87121-2	6	10	0.68
66653 / 789-21	38"	78921-0	6	13	0.68

STRAIGHT HOLLOWBACK SHOVEL HANDLES WITHOUT SHOULDER

STRAIGHT HOLLOWBACK SHOVEL HANDLES WITHOUT SHOULDER, STEEL D-GRIP

1-1/2" diameter, 9-1/2" chuck with slot



(Assembled in the USA)

Model	Length	UPC 0 25545 +	Pack qty	Pack wgt	Pack cube
66778 / 873-21	30"	87321-6	6	10	0.68

LONG STRAIGHT HOLLOWBACK SHOVEL HANDLES WITHOUT SHOULDER

1-1/2" diameter, 9-1/2" chuck with slot



Model	Length	UPC 0 25545 +	Pack qty	Pack wgt	Pack cube
66787 / 881-21	48"	88121-1	6	10	0.53



ALL PRODUCTS ON THIS PAGE ARE MADE IN THE USA (UNLESS NOTED)

CLOSED BACK SHOVEL HANDLES WITH SHOULDER

CLOSED BACK SOLID SHANK SHOVEL AND SPADE HANDLES WITH SHOULDER, STEEL D-GRIP

1-1/2" diameter, 6-1/2" chuck, regular weight



(Assembled in the USA)

Model	Length	UPC 0 25545 +	Pack qty	Pack wgt	Pack cube
66722 / 834-21	24"	83421-7	6	8	0.68

CLOSED BACK SOLID SHANK SHOVEL AND SPADE HANDLES WITH SHOULDER

1-1/2" diameter, 5-1/2" chuck, featherweight



Model	Length	UPC 0 25545 +	Pack qty	Pack wgt	Pack cube
66724 / 836-21	44-1/2"	83621-1	6	8	0.68

CLOSED BACK SOLID SHANK SHOVEL AND SPADE HANDLES WITH SHOULDER, STEEL D-GRIP

1-1/2" diameter, 5-1/2" chuck, featherweight



(Assembled in the USA)

Model	Length	UPC 0 25545 +	Pack qty	Pack wgt	Pack cube
66727 / 838-21	24"	83821-5	6	8	0.68

CLOSED BACK SOLID SHANK SHOVEL AND SPADE HANDLES WITH SHOULDER

1-1/2" diameter, 6-1/2" chuck



Model	Length	UPC 0 25545	Pack +qty	Pack wgt	Pack cube
66798 / 896-21	44-1/2"	89621-5	6	8	0.53
66800 / 897-21	46-1/2"	89721-2	6	9	0.53
66801 / 898-21	48"	89821-9	6	10	0.53

GENERAL PURPOSE SHOVEL HANDLE WITH SHOULDER

1-1/2" diameter



Model	Length	UPC 0 25545 +	Pack qty	Pack wgt	Pack cube
66833 / 990-21	48"	99021-0	6	9	0.53

CLOSED BACK SHOVEL HANDLES WITHOUT SHOULDER

CLOSED BACK SOLID SHANK SHOVEL HANDLES WITHOUT SHOULDER, STEEL D-GRIP

1-1/2" diameter, 4-1/2" chuck



(Assembled in the USA)

Model	Length	UPC 0 25545 +	Pack qty	Pack wgt	Pack cube
66673 / 807-21	24"	80721-1	6	9	0.68
66675 / 808-21	25-1/2"	80821-8	6	9	0.68

CLOSED BACK SOLID SHANK SHOVEL HANDLES WITHOUT SHOULDER

1-1/2" diameter, 4-1/2" chuck



Model	Length	UPC 0 25545 +	Pack qty	Pack wgt	Pack cube
66733 / 844-21	44-1/2"	84421-6	6	9	0.53
66728 / 841-21	46-1/2"	84121-5	6	9.5	0.53
66730 / 842-21	48"	84221-2	6	10	0.53

CLOSED BACK SOLID SHANK SHOVEL HANDLES WITHOUT SHOULDER

1-1/2" diameter, 5-1/2" chuck



Model	Length	UPC 0 25545 +	Pack qty	Pack wgt	Pack cube
66831 / 989-21	44"	98921-4	6	9	0.86
66813 / 950-21	48"	95021-4	6	10	0.53

CLOSED BACK SOLID SHANK SHOVEL HANDLES WITHOUT SHOULDER, STEEL D-GRIP

1-1/2" diameter, 5-1/2" chuck



(Assembled in the USA)

Model	Length	UPC 0 25545 +	Pack qty	Pack wgt	Pack cube
66816 / 951-21	24"	95121-1	6	8	0.68
66819 / 952-21	27"	95221-8	6	9	0.68
66820 / 953-21	30"	95321-8	6	10	0.68

PLOW HANDLE & WALKING STICK

PLOW HANDLE

56" walking plow handle, red oak

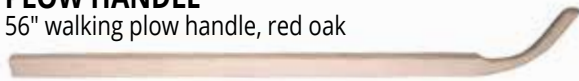

Model	Length	UPC 0 25545 +	Pack qty	Pack wgt	Pack cube
64205 / 22-388	56"	05115-7	2	3.2	1.79

BENT WALKING STICK / CANE

37.5" waling stick / cane, red oak



Model	Length	UPC 0 25545 +	Pack qty	Pack wgt	Pack cube
64207 / 22-849	37.5"	53601-2	12	13.2	1.35

D-GRIPS

TUBULAR STEEL D-GRIP

Rugged steel D-grips are designed to provide the best combination of balance, grip, and comfort. Sized to provide the best grip for both gloved and ungloved hands.



(Assembled in the USA)

Model	UPC 0 25545 +	Pack qty	Pack wgt	Pack cube
64084 / 50001-00	00048-3	12	10	0.45

POLY D-GRIP

Extra-large D-grip handle designed to provide more room for gloved hands. Solid polypropylene grip is light weight yet durable. 1-1/4" diameter socket.



Model	UPC 0 25545 +	Pack qty	Pack wgt	Pack cube
64085 / 50025-00	05492-9	12	8	0.40

IRON RIVETS

IRON RIVETS* FOR SHOVEL HANDLES

Rivets are furnished with each shovel handle. It is wise, however, to have extra rivets on hand.

3/16" diameter, 1-3/4" long



Model	UPC 0 25545 +	Pack qty	Pack wgt	Pack cube
64098 / 50005-00	00052-0	1	8 oz.	0.08
64099 / 50006-00	00053-7	1	1 oz.	0.04

*(64098 contains 4 rivets per package, 64099 has 36)



ALL PRODUCTS ON THIS PAGE
ARE MADE IN THE USA (UNLESS NOTED)

OUR SAWMILL LOCATIONS



SEYMOUR, IN



SEQUATCHIE, TN



ALTAMONT, TN

BETTER BY DESIGN

When your customers buy tool handles, they need handles with proper fit. The handle becomes an extension of their bodies and determines the comfort of the user. Link® handles provide the time tested ergonomic shape and design that allows for better control, comfort, and safety.

CLAW HAMMERS, 16 OZ.

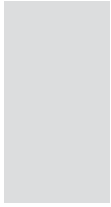

Handle models
300
304

1-1/16" X 9/16"

CLAW HAMMERS, 20 TO 24 OZ.

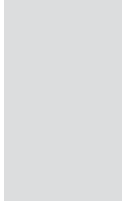

Handle models
310
312
313

1-1/16" X 5/8"

CLAW HAMMERS, 28 TO 32 OZ.

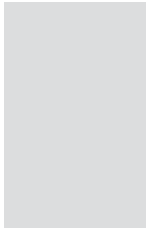

Handle models
321
322

1-3/16" X 3/4"

BALL PEIN HAMMERS, 16 TO 20 OZ.

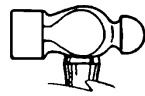

Handle models
405

29/32" X 17/32"

BALL PEIN HAMMERS, 24 TO 28 OZ.

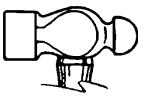

Handle models
407

1-1/16" X 19/32"

ENGINEER OR BLACKSMITH OR DRILLING HAMMERS



Handle models
423
424
480
481

1" X 3/4"

BLACKSMITH HAMMERS, 3-1/2 LB. AND HEAVIER



Handle models
432
433

1-1/4" X 1"

SLEDGES AND MAULS, 6 TO 16 LB., OVAL EYE

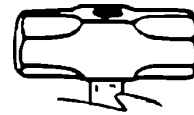

Handle models
001 003
002 004

1-1/4" X 1"

SLEDGES AND MAULS, 18 TO 24 LB.

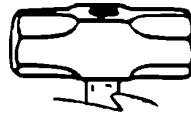
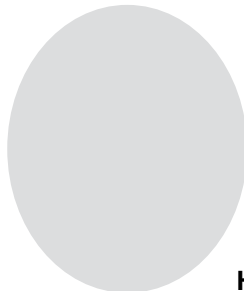

Handle models
010
023

1-1/2" X 1-1/4"

SPLITTING MAULS, NO. 5 EYE

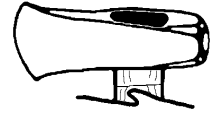

Handle models
205

2-1/8" X 7/8"

SINGLE BIT SPLITTING MAULS

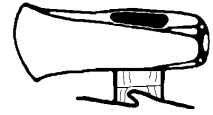

Handle models
206

2-5/16" X 13/16"

SCOUT OR HUNTER AXES, 1-3/4 LB.

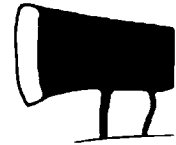

Handle models
369

1-3/4" X 11/16"

DOUBLE-BIT AXES, 3-5 LB.



Handle models
140
142

2-7/8" X 5/8"

SCOUT AXES, 1-1/4 LB.

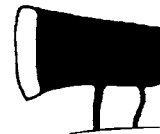

Handle models
368

1-11/16" X 5/8"

BROAD HATCHETS

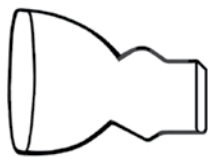

Handle models
334

1-5/8" X 19/32"

HALF HATCHETS



Handle models
330

1-17/32" X 17/32"

GRUB HOES, NO. 8 EYE

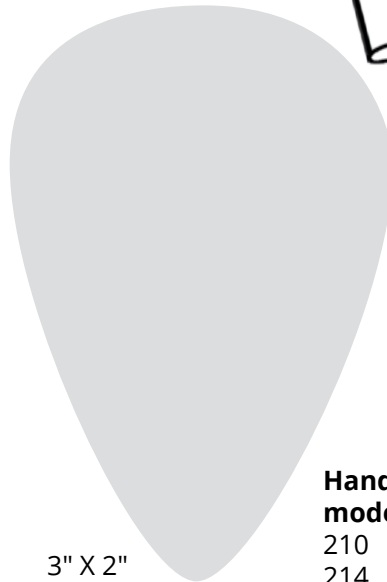

Handle
models
210
214
215

3" X 2"

RAILROAD OR CLAY PICKS & MATTOCKS, NO. 6 EYE

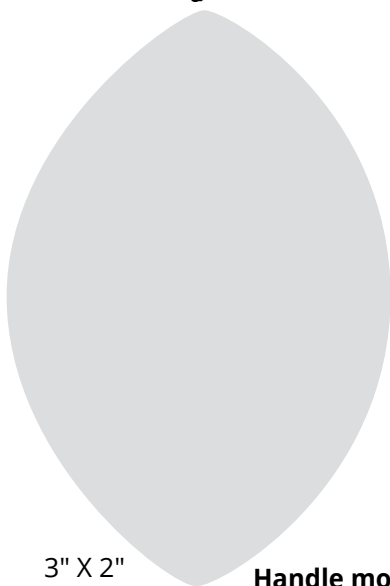
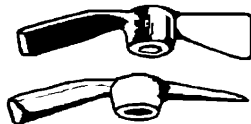

3" X 2"

Handle models
220

GARDEN OR NURSERY MATTOCKS, NO. 7 EYE

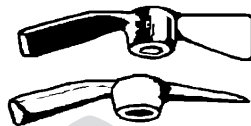

Handle
models
240

2-3/4" X 1-3/4"

SMALL EYE GRUB HOES, NO. 9 EYE

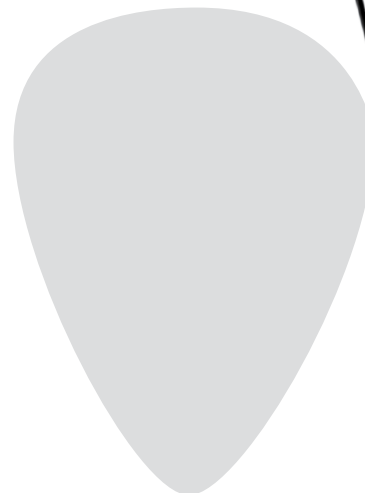

2-1/2" X 1-7/8"

Handle models
216

CARPENTER'S ADZE

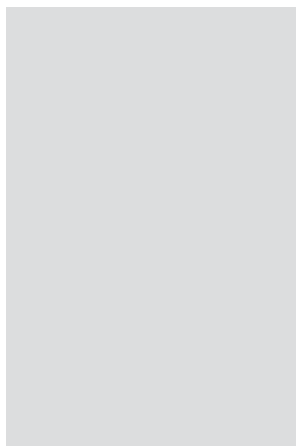

Handle
models
224

2-5/16" X 1-1/2"

DOUBLE BIT GARDEN MATTOCKS, NO. 10 EYE

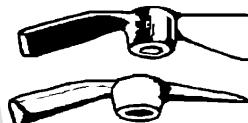

Handle models
200

3" X 1"

SOD LIFTER, EDGERS, ROLLER & SPREADER



Our lawn roller helps even-out new sod installations and holds up to 270 lbs. (approx. 28 gallons) of water.

Edgers create crisp turf boundaries along walkways, driveways and other paved surfaces. Gardeners and landscapers appreciate the easy, precise cuts from our half-moon edger.

Our compost spreader is often used for topdressing existing lawns.

63222 - Sod Roller Replacement Plug

#	SMW # LEGACY #	SERIES	WARRANTY	DESCRIPTION	HEAD STYLE	HEAD-TO-HANDLE	HANDLE TYPE	GRIP	UPC	PACK QTY	PACK WEIGHT
1	49079 SD-20	S500 Industrial™	Limited Lifetime	Sod Lifter	8.75" Steel Half Moon	8" Ferrule with Solid Steel Rivet	31" Precision Lathe Turned American Hardwood	Steel D	031365122069	3	16.2
2	49042 WE-60	S400 Jobsite™	Limited Lifetime	Turf Edger	8.75" Steel Half Moon	Welded Ferrule with Screw	48" Precision Lathe Turned American Hardwood	-	031365024202	2	4
3	49043 WE-65	S500 Industrial™	Limited 15 Year	Turf Edger	8.75" Steel Half Moon	Cast Iron Ferrule with Screw	48" Precision Lathe Turned Hardwood	-	031365024301	2	6
4	49048 WE-52	S400 Jobsite™	Limited 15 Year	Turf Edger	Dual Wheel 6" Rotary Blade	Double Bolted	48" Precision Lathe Turned Hardwood	-	031365024103	2	7.9
5	49047 WE-51	S400 Jobsite™	Limited 15 Year	Turf Edger	Single Wheel 6" Rotary Blade	Double Bolted	48" Precision Lathe Turned Hardwood	-	031365024004	2	4.8
6	85750	S500 Industrial™	Limited Lifetime	Sod Roller	14 Gauge / 24" Wide & 18" Diameter Solid	Double Bolts	Steel Handle	T-Shaped Hand Hold	046385857501	1	43
7	85755	S500 Industrial™	Limited Lifetime	Compost Spreader	24" Wide & 18" Diameter Perforated	Double Bolts	Steel Handle	T-Shaped Hand Hold	046385857556	1	31.2

SNATHS

All of our wooden handled snaths are made of river-bottom wood which is ideal for forming into shape.

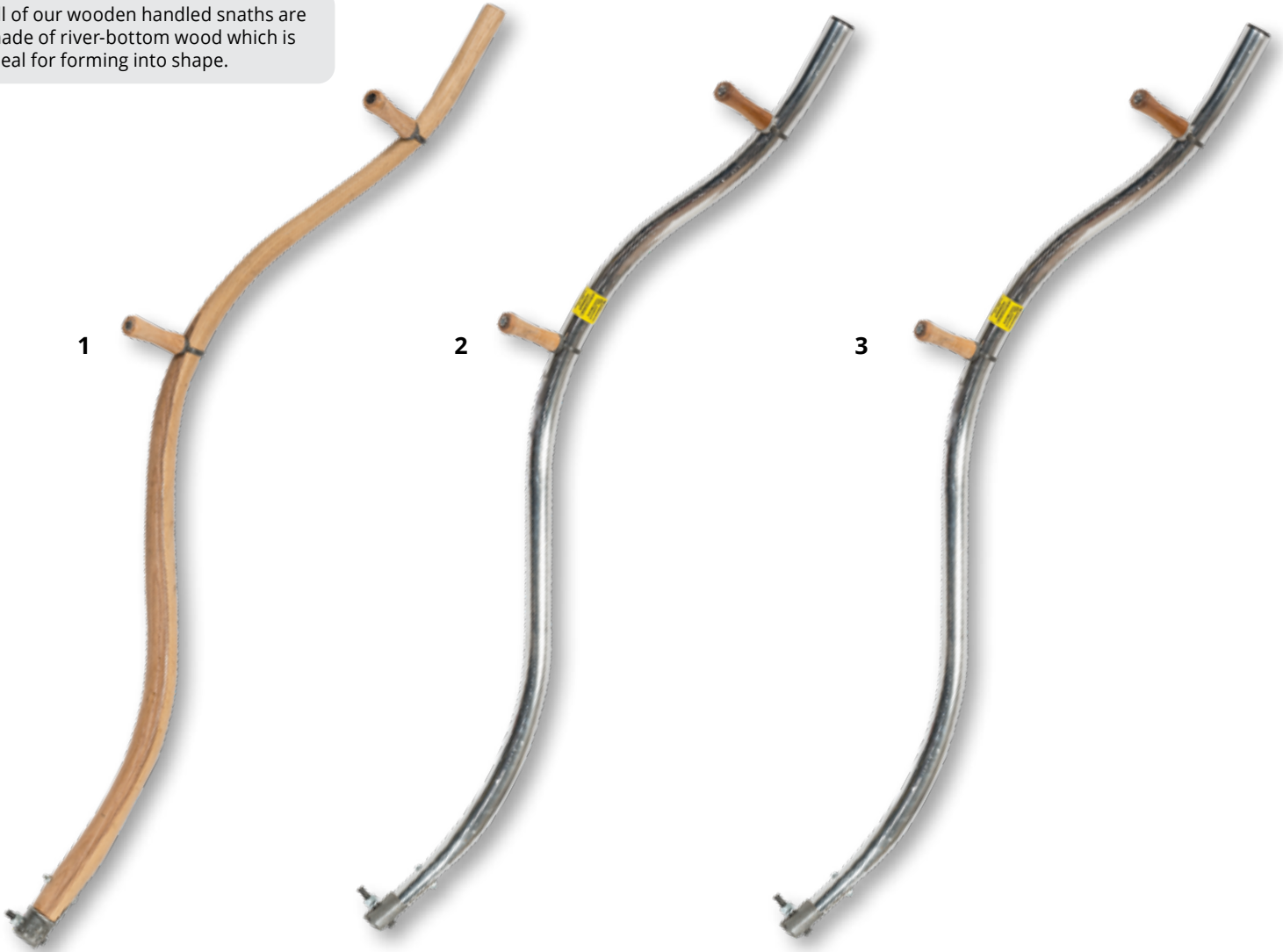

○ = Good ◐ = Better ● = Best ✕ = Do Not Use

RM61005 - Loop Bolt

SNATH STYLE	LIGHT, THIN GRASSES	LUSH VEGETATION	REEDY GRASSES & THATCH	WOODY-STEMMED PLANTS & WEEDS	GREEN YOUNG SAPLINGS OR BUSHES
No. 1 (Wood)	◐	◐	●	●	●
No. 8 (Aluminum)	●	●	○	✕	✕
No. 9 (Aluminum)	◐	●	◐	○	✕

#	SMW # LEGACY #	SERIES	WARRANTY	DESCRIPTION	LIGHT / THIN GRASSES	LUSH VEGETATION	REEDY GRASSES & THATCH	WOODY-STEMMED PLANTS & WEEDS	GREEN YOUNG SAPLINGS OR BUSHES	UPC	PACK QTY	PACK WEIGHT
1	21401 SN-1	S500 Industrial™	Limited Lifetime	#1 Tapered Wood Snath with Steel Web, Iron Loop Bolt, Hand Sanded	Better	Better	Best	Best	Best	031365040103	3	6.6
2	21408 SN-8	S500 Industrial™	Limited Lifetime	#8 / 1.25" Outside Diameter Straight Aluminum Snath with Steel Web, Iron Loop Bolt	Best	Best	Good	Do Not Use	Do Not Use	031365040301	3	6.6
3	21409 SN-9	S500 Industrial™	Limited Lifetime	#9 / 1.5" Outside Diameter Straight Aluminum Snath with Steel Web, Iron Loop Bolt	Better	Best	Better	Good	Do Not Use	031365040400	3	7.2

SCYTHER BLADES

The scythe is a powerful, versatile and useful tool for the mowing and removal of unwanted grasses, weeds, and young woody growth. Quiet and pleasant to use, the scythe provides numerous advantages over mechanical mowers and string trimmers, and can be used in many locations where mechanical mowers cannot.



○ = Good ◐ = Better ● = Best ✕ = Do Not Use

SCYTHER STYLE	LIGHT, THIN GRASSES	LUSH VEGETATION	REEDY GRASSES & THATCH	WOODY-STEMMED PLANTS & WEEDS	GREEN YOUNG SAPPLINGS OR BUSHES
Grass Blade	●	●	◐	◐	○
Weed Blade	◐	◐	●	●	◐
Bush Blade	○	○	◐	◐	●
Hybrid Blade	●	◐	○	○	✕

#	SMW # LEGACY #	SERIES	WARRANTY	DESCRIPTION	LIGHT / THIN GRASSES	LUSH VEGETATION	REEDY GRASSES & THATCH	WOODY-STEMMED PLANTS & WEEDS	GREEN YOUNG SAPPLINGS OR BUSHES	UPC	PACK QTY	PACK WEIGHT
1	21428 2B-42G28	S500 Industrial™	Limited Lifetime	28" Steel Grass Scythe	Best	Best	Better	Better	Good	031365101804	3	4.8
1	21430 2B-42G30	S500 Industrial™	Limited Lifetime	30" Steel Grass Scythe	Best	Best	Better	Better	Good	031365101903	3	2.4
2	21424 2B-42W24	S500 Industrial™	Limited Lifetime	24" Steel Weed Scythe	Better	Better	Best	Best	Better	031365101507	3	4.8
2	21426 2B-42W26	S500 Industrial™	Limited Lifetime	26" Steel Weed Scythe	Better	Better	Best	Best	Better	031365010168	3	4.8
3	21420 2B-42B20	S500 Industrial™	Limited Lifetime	20" Steel Bush Scythe	Good	Good	Better	Better	Best	031365101309	3	2.4
4	21438 2B-040128	S500 Industrial™	Limited Lifetime	28" Lightweight Steel Hybrid	Best	Better	Good	Good	Do Not Use	031365102405	3	3
5	21450 SP-16UB	S500 Industrial™	Limited Lifetime	1.5" Lower and Upper Nib	For 21401 and Both for 21409	Reverse Threaded Nut	-	-	-	031365041001	6	1.2
5	21451 SP-16LB	S500 Industrial™	Limited Lifetime	1.75" Lower Bush Nib	For 21401	Reverse Threaded Nut	-	-	-	031365041025	6	1.2
5	21452 SP-16UG	S500 Industrial™	Limited Lifetime	1.25" Grass Nib	For 21401 and Both for 21408	Reverse Threaded Nut	-	-	-	031365041018	6	1.2

WEED & BRUSH CUTTING

Cutting dense brush and weeds is easy with our time-proven grass hooks, weed cutters and ditch bank blades. These rugged tools are based on decades-old designs that continue to be reliable favorites for their reliability and functionality.



SP21104 - Replacement Handle for Ditch Bank Blade

#	SMW # LEGACY #	SERIES	WARRANTY	DESCRIPTION	HEAD STYLE	HEAD-TO-HANDLE	HANDLE TYPE	UPC	PACK QTY	PACK WEIGHT
1	87640 DT-1640	S500 Industrial™	Limited Lifetime	Ditch Bank Blade	Hardened Steel	3-Bolt Bracket	40" Precision Lathe Turned Hickory	031365050904	6	33
2	87610 WE-40	S500 Industrial™	Limited Lifetime	Brush Cutter	Heavy-Duty Steel	Double Bolted	30" Precision Lathe Turned American Hardwood	031365051505	3	10.7
3	87600 WE-20	S500 Industrial™	Limited Lifetime	Weed Cutter	Serrated Edges	Steel Brackets with Double Bolt	30" Precision Lathe Turned American Hardwood	031365051208	6	17.7
4	87605 WE-30	S400 Jobsite™	Limited 15 Year	Grass Whip	Serrated Edges	Riveted to Steel Shaft	12" Precision Lathe Turned American Hardwood	031365051406	6	6
5	87625 WE-35	S400 Jobsite™	Limited 15 Year	Dandelion Weeder	Steel V-Tip	Steel Ferrule	36" Precision Lathe Turned American Hardwood	031365050355	6	8



#	SMW # LEGACY #	SERIES	WARRANTY	DESCRIPTION	HEAD STYLE	HEAD-TO-HANDLE	HANDLE TYPE	GRIP	UPC	PACK QTY	PACK WEIGHT
1	41711 2G-25LH	S500 Industrial™	Limited Lifetime	American Pattern Grass Hook	Plain Edge	Steel Ferrule	53" American Hardwood	-	031365100609	6	9.6
2	41700 2G-497	S500 Industrial™	Limited Lifetime	General Purpose Grass Hook	Non-Offset Serrated Edge	Steel Shank	Hardwood	-	031365100807	6	3
3	41705 2G-507	S500 Industrial™	Limited Lifetime	General Purpose Grass Hook	Offset Plain Edge	Steel Shank	Hardwood	-	031365100906	6	3
4	49081	S500 Industrial™	Limited Lifetime	Hay Hook	Steel	One-Piece Design	11" Overall Length	Wood Grip	046385490814	6	14.4

MACHETES

Whether you are trimming, harvesting or clearing brush, we have the high-quality tool ready for the task. Each of our tough and durable products are fully resharpenable for use season after season.



#	SMW # LEGACY #	SERIES	WARRANTY	DESCRIPTION	HEAD STYLE	HEAD-TO-HANDLE	GRIP TYPE	BLADE	UPC	PACK QTY	PACK WEIGHT
1	41712 2P-MA12	S400 Jobsite™	Limited 15 Year	Machete	12" High Carbon Cutlery Steel	4 Brass Rivets	Polymer Comfort Grip	Resharpenable Blade	031365050300	12	4.8
2	41719 2P-MA18S	S400 Jobsite™	Limited 15 Year	Machete Sheath	18" Canvas	Belt Loop	-	-	031365050805	12	1.2
3	41718 2P-MA18	S400 Jobsite™	Limited 15 Year	Machete	18" High Carbon Cutlery Steel	4 Brass Rivets	Polymer Comfort Grip	Resharpenable Blade	031365050409	6	6
4	41723 2P-MA22S	S400 Jobsite™	Limited 15 Year	Machete Sheath	22" Canvas	Belt Loop	-	-	031365050812	12	0.12
5	41722 2P-MA22	S400 Jobsite™	Limited 15 Year	Machete	22" High Carbon Cutlery Steel	4 Brass Rivets	Polymer Comfort Grip	Resharpenable Blade	031365050508	12	12
6	41725 2P-MA24S	S400 Jobsite™	Limited 15 Year	Machete Sheath	24" Canvas	Belt Loop	-	-	031365050829	12	1.2
7	41724 2P-MA24	S400 Jobsite™	Limited 15 Year	Machete	24" High Carbon Cutlery Steel	4 Brass Rivets	Polymer Comfort Grip	Resharpenable Blade	031365050607	12	16.8



Cane knives feature a wide, blunt-tipped blade perfect for hacking corn stalks and sugar cane. The blade is hooked to allow the user to pull the chopped cane from the plants still standing.

#	SMW # LEGACY #	SERIES	WARRANTY	DESCRIPTION	HEAD STYLE	HEAD-TO-HANDLE	GRIP TYPE	BLADE	UPC	PACK QTY	PACK WEIGHT
1	41418	S550 Irrigation™	Limited Lifetime	Sickle / Sod Cutter	4" Steel	Molded	6" Polymer Comfort Grip	Resharpenable Blade	046385414186	1	2.4
2	41420	S550 Irrigation™	Limited Lifetime	Sickle	6.5" Steel	Steel Ferrule	8" Wood Comfort Grip	Resharpenable Blade	046385414209	1	48
3	41046	S400 Jobsite™	Limited 15 Year	Row Crop Harvesting Knife	6" Steel	Molded	5" Polymer Comfort Grip	Resharpenable Blade	046385410461	1	0.4
4	41044	S400 Jobsite™	Limited 15 Year	Sod Cutter / Harvesting Knife	3" Steel	Molded	5" Polymer Comfort Grip	Resharpenable Blade	185227000726	1	2.4
5	41045	S400 Jobsite™	Limited 15 Year	Landscaper's Pocket Knife	2.5" Closeable Steel	Rivet Hinge	4.5" Polymer Comfort Grip	Resharpenable Blade	046385410454	1	8
6	41730 2P-CN13	S400 Jobsite™	Limited 15 Year	Cane Knife	13" High Carbon Cutlery Steel with Hook	3 Brass Rivets	Hardwood Comfort Grip	Resharpenable Blade	031365050201	12	16.8
7	41745 2C-66	S400 Jobsite™	Limited 15 Year	Corn Knife	15" x 2.75" High Carbon Cutlery Flexible Steel	2 Brass Rivets	Hardwood Comfort Grip	Resharpenable Blade	031365100203	6	4.8
8	41740 2C-33	S400 Jobsite™	Limited 15 Year	Corn Knife	18" x 1.25" High Carbon Cutlery Steel	2 Brass Rivets	Hardwood Comfort Grip	Resharpenable Blade	031365100104	6	6
9	41748 2C-99	S400 Jobsite™	Limited 15 Year	Corn Knife	18" x 3" High Carbon Cutlery Steel	2 Brass Rivets	Hardwood Comfort Grip	Resharpenable Blade	031365100302	6	8.4



Pruning saws are professional-grade tools that are designed to cut more easily. Choose folding models for small to medium branches and convenient in-field portability. Curved blades make cutting easier.

SP16047 - 21" Replacement Blade for 41453

#	SMW # LEGACY #	SERIES	WARRANTY	DESCRIPTION	HEAD STYLE	HEAD-TO-HANDLE	GRIP TYPE	GRIP	UPC	PACK QTY	PACK WEIGHT
1	41426 WP-8708	S550 Irrigation™	Limited Lifetime	Folding Pruning Saw	8" Serrated Steel Blade	Folding Hinge	Comfort Poly Handle	Hanging Hole	031365053301	1	7.2
2	41453 WP-7621	S500 Industrial™	Limited Lifetime	Bow Saw	21" Steel Blade	Easy-Change Blade Release	Tubular Steel Handle	-	031365053257	1	13.2



Classic design and dependability characterize each of our pruning tools. We offer the best in price and performance with tools that provide clean, consistent cuts, without binding or tearing.

SP13312 - 1" Replacement Blade for 41407
 SP13311 - 1" Replacement Spring for 41407
 SP13310 - 1" Replacement Spring for 41406

#	SMW # LEGACY #	SERIES	WARRANTY	DESCRIPTION	HEAD STYLE	HINGE	GRIP TYPE	GRIP	UPC	PACK QTY	PACK WEIGHT
1	41407	S550 Irrigation™	Limited Lifetime	1" Bypass Pruner	Forged Resharpenable Blade with Sap-Groove & Wire Cutting Notch	Spring-Open with Steel Latch	Ergonomically Designed	Vinyl Coated	046385414070	1	0.8
2	41406	S550 Irrigation™	Limited Lifetime	.75" Bypass Pruner	Forged Resharpenable Blade with Sap-Groove & Wire Cutting Notch	Spring-Open with Steel Latch	Ergonomically Designed	Vinyl Coated	046385414063	10	37.5
3	41403	S550 Irrigation™	Limited Lifetime	1" Bypass Pruner	Hardened Non-Gumming Blade	Steel Latch for Safe Storage	Ergonomically Designed	Vinyl Coated	046385414032	6	26.0
4	41474 WP-1030	S400 Jobsite™	Limited 15 Year	.625" Bypass Pruner	Single Action Steel Blade	Enclosed Spring	Ergonomically Designed	Textured Vinyl Grips	031365053028	1	6
5	41473 WP-1010	S300 Duralite™	Limited 5 Year	.5" Bypass Pruner	Steel Blade	Quick Release	Comfort Molded Handles	Hanging Hole	031365053004	6	3.6
6	41476 WP-1020	S400 Jobsite™	Limited 15 Year	.625" Anvil Pruner	Single Action Steel Blade	Enclosed Spring	Textured Vinyl Grips	-	031365053011	6	8.4
7	41055	S550 Irrigation™	Limited Lifetime	Scabbard	Top-Grain Leather with Belt Slots	-	-	-	046385410553	1	0.4
8	41054	S550 Irrigation™	Limited Lifetime	Scabbard	Nylon with Belt Clip	Fits Hand Pruners and Folding Saws	-	-	046385410546	1	0.2

PRUNING - HEDGE SHEARS

For trimming and shaping of large and dense shrubs and hedges, we offer a diverse selection of hedge shears for contractor and consumer use. Of special note are the models which incorporate innovative telescoping handles for instant added reach. All models feature resharpenable blades.



#	SMW # LEGACY #	SERIES	WARRANTY	DESCRIPTION	BLADE DESCRIPTION	HEAD-TO- HANDLE	HANDLE TYPE	GRIP	UPC	PACK QTY	PACK WEIGHT
1	41424	S550 Irrigation™	Limited Lifetime	Hedge Shears	9" Steel Blades	Shock Absorbing Stop	12" Aluminum Handles	Poly Grip	046385414247	1	31.2
2	41423	S550 Irrigation™	Limited Lifetime	Hedge Shears	9" Steel Blades	Shock Absorbing Stop	11" Hardwood Handles	Poly Grip	046385414230	1	28.8
3	41492 WP-3230	S400 Jobsite™	Limited 15 Year	Hedge Shears	9" Steel Blades with Serrated Edge	Steel Ferrule	10" Hardwood Handles	Cushion Grip with Hanging Tip	031365053172	6	14.4
4	41422 WP-3210	S300 DuraLite™	Limited 5 Year	Hedge Shears	8" Steel Blades	-	9" Steel Handles	Vinyl Coated with Hanging Tip	031365053158	6	10.2
5	41421 WP-3220	S300 DuraLite™	Limited 5 Year	Hedge Shears	8" Steel Blades with Pruning Notch	Steel Ferrule	11" Hardwood Handles	-	031365053165	6	22.8

EXTENSION HANDLES

The 41463 features a dual lock and STÅ-LOK® positive locking system (SA32002) that increases the reach of Structron® loppers and hedge shears.

COMPOUND ACTION LEVER DESIGN

The 41463 & 41461 pruning tools multiplies handle force to cutting blades for easier cutting.



For cutting larger limbs and vines, select from our wide offering of landscape loppers. Choose from models with traditional hardwood handles, fatigue-reducing aluminum, fiberglass, or high-strength tubular steel. Models with easy-reach extension handles are offered.

#	SMW # LEGACY #	SERIES	WARRANTY	DESCRIPTION	BLADE DESCRIPTION	HEAD-TO-HANDLE	HANDLE TYPE	GRIP	UPC	PACK QTY	PACK WEIGHT
1	41463 STR-EXA36	S600 Power™	Limited Lifetime	2" Anvil Lopper	Compound Action Steel Blades	Double Solid Steel Rivets	24" - 33" Premium Fiberglass	ProGrip™	036723010200	4	14.4
2	41461 STR-CL24	S600 Power™	Limited Lifetime	2" Anvil Lopper	Compound Action Steel Blades	Double Solid Steel Rivets	24" Premium Fiberglass	ProGrip™	036723010217	4	12.8
3	41489 WP-2145	S500 Industrial™	Limited Lifetime	2" Anvil Lopper	Compound Action Steel Blade	Steel Ferrule	20" Hardwood Handles	Cushion Grip with Hanging Tip	031365053332	6	16.8
4	41485 WP-2135	S400 Jobsite™	Limited 15 Year	1.5" Anvil Lopper	Single Action Steel Blade	Steel Ferrule	20" Hardwood Handles	Cushion Grip with Hanging Tip	031365053318	6	13.2
5	41483 WP-2110	S300 DuraLite™	Limited 5 Year	1.5" Anvil Lopper	Single Action Steel Blade	-	19" Tubular Steel Handles	Vinyl Grip	031365053073	6	15

PRUNING TOOLS - BYPASS LOPPERS

EXTENSION HANDLES

The 41467 features a dual lock and STĀ-LOK® positive locking system (SA32002) that increases the reach of Structron® loppers and hedge shears.



#	SMW # LEGACY #	SERIES	WARRANTY	DESCRIPTION	HEAD STYLE	HEAD-TO-HANDLE	HANDLE TYPE	GRIP	UPC	PACK QTY	PACK WEIGHT
1	41467 STR-EXB36	S600 Power™	Limited Lifetime	1.5" Bypass Lopper	Single Action Steel Blades	Double Solid Steel Rivets	24" - 33" Premium Fiberglass	ProGrip™	036723010101	4	12
2	41465 STR-BL24	S600 Power™	Limited Lifetime	1.5" Bypass Lopper	Single Action Steel Blades	Double Solid Steel Rivets	24" Premium Fiberglass	ProGrip™	036723010118	4	12
3	41415	S550 Irrigation™	Limited Lifetime	2.25" Bypass Lopper	Resharpener Blade with Sap Groove	Shock Absorbing Stop	28" Aluminum	Poly	046385414155	6	31.2
4	41486 WP-2136	S400 Jobsite™	Limited 15 Year	1.5" Bypass Lopper	Single Action Steel Blades	Shock Absorbing Stop	30" Hardwood Handles	-	031365053288	6	19.2
5	41414	S550 Irrigation™	Limited Lifetime	1.5" Bypass Lopper	Resharpener Blades with Sap Groove	Shock Absorbing Stop	19" Overall Length	Poly	046385414148	6	21.6
6	41487 WP-2137	S400 Jobsite™	Limited 15 Year	1.5" Bypass Lopper	Single Action Steel Blades	Shock Absorbing Stop	30" Hardwood Handles	Cushion Grip with Hanging Tip	031365053295	6	21.6
7	41411	S550 Irrigation™	Limited Lifetime	1.5" Bypass Lopper	Non-Gumming Blades	Shock Absorbing Stop	29" Aluminum	Poly	046385414117	6	28.8

BYPASS LOPPERS - PRUNING TOOLS



#	SMW # LEGACY #	SERIES	WARRANTY	DESCRIPTION	BLADE DESCRIPTION	HEAD-TO- HANDLE	HANDLE TYPE	GRIP	UPC	PACK QTY	PACK WEIGHT
1	41416	S550 Irrigation™	Limited Lifetime	1.5" Bypass Lopper	Hardened, Non-Gumming Blades	Shock Absorbing Stop	26" - 39" Aluminum Handles	Poly	046385414162	6	26.4
2	41417	S550 Irrigation™	Limited Lifetime	1.5" Bypass Lopper	Hardened, Non-Gumming Blades	Shock Absorbing Stop	28" Overall Length with Hardwood Handles	Poly	046385414179	6	33.6
3	41488 WP-2140	S500 Industrial™	Limited Lifetime	2" Bypass Lopper	Compound Action Steel Blade	Shock Absorbing Stop	20" Hardwood Handles	Cushion Grip with Hanging Tip	031365053103	6	21.6
4	41484 WP-2130	S400 Jobsite™	Limited 15 Year	1.5" Bypass Lopper	Single Action Steel Blade	Shock Absorbing Stop	20" Hardwood Handles	Cushion Grip with Hanging Tip	031365053097	6	15.6
5	41481 WP-2120	S300 DuraLite™	Limited 5 Year	1.5" Bypass Lopper	Single Action Steel Blade	Shock Absorbing Stop	19" Tubular Steel Handles	Vinyl Grip with Hanging Tip	031365053080	6	14.4

PRUNING TOOLS - TREE PRUNERS & FRUIT PICKER

Our rugged tree pruners use telescoping fiberglass or aluminum handles for extended reach and lightweight operation. The exclusive STĀ-LOK on the Structron® 41398 locks the handle in place to the exact length needed. Choose a model with compound action for extra cutting power.



SA11013 - Tree Pruner Head for 41398
 SP16130 - Replacement Head for 41395
 SP50323 - Pole Pruner Replacement Rope for 41395, 41499, 41498

#	SMW # LEGACY #	SERIES	WARRANTY	DESCRIPTION	HEAD STYLE	HEAD-TO-HANDLE	HANDLE TYPE	GRIP	UPC	PACK QTY	PACK WEIGHT
1	41398 STR-TP612	S600 Power™	Limited Lifetime	Tree Pruner	15" Saw Blade with 1.125" Cutting Lopper	Solid Steel Rivet	6' - 12' Fiberglass Handle	ProGrip™	036723036125	4	19.2
2	41395 WP-6555	S400 Jobsite™	Limited 15 Year	Tree Pruner	13" Saw Blade with 1.125" Cutting Lopper	Locking Mechanism	7' - 14' Fiberglass Handle	Cushion	031365053370	4	28.4
3	41499 WP-6535	S300 DuraLite™	Limited 5 Year	Tree Pruner	13" Saw Blade with 1.125" Cutting Lopper	Locking Mechanism	6' - 12' Fiberglass Handle	Nylon Cap	031365053349	4	17.6
4	41498 WP-6525	S300 DuraLite™	Limited 5 Year	Tree Pruner	13" Saw Blade with 1" Cutting Lopper	Locking Mechanism	6' - 12' Fiberglass Handle	Nylon Cap	031365053226	4	13.6
5	42280 FP-20	S400 Jobsite™	Limited 15 Year	Fruit Picker	Heavy Gauge Vinyl Coated Wire	Secure Clamp	8' - 2 Piece Wood Handle	-	031365125978	1	31.2

Our long-handled garden tools are the perfect fit for garden beds, smaller spaces and smaller hands. They are smaller and easier-to-use but are constructed of the same materials as our larger tools. Their versatility extends to floral or edible gardens, square-foot gardening, raised beds and use by children.



Kit #60749 Seymour Garden Tools Rolling Display with Signs, 24" X 24" Footprint

#	SMW # LEGACY #	SERIES	WARRANTY	DESCRIPTION	HEAD STYLE	HEAD-TO-HANDLE	HANDLE TYPE	GRIP	UPC	PACK QTY	PACK WEIGHT
1	60701 SV-DR72	S400 Jobsite™	Limited 15 Year	Floral Round Point Shovel	Tempered Steel	Forward Turned Step	30" Hardwood	Poly D	031365131078	6	13.2
2	60700 SV-LR70	S400 Jobsite™	Limited 15 Year	Floral Round Point Shovel	Tempered Steel	Forward Turned Step	44" Hardwood	-	031365127064	6	13.2
3	60703 SV-DS73	S400 Jobsite™	Limited 15 Year	Floral Square Point Shovel	Tempered Steel	Forward Turned Step	30" Hardwood	Poly D	031365120515	6	14.4
4	60710 VH-70	S400 Jobsite™	Limited 15 Year	V Hoe	Forged 4"	Ferrule	54" Hardwood	-	031365126128	6	9.6
5	60711 GC-70	S400 Jobsite™	Limited 15 Year	Cultivator	Forged 3-Prong	Ferrule	54" Hardwood	-	031365127057	6	10.8
6	60712 FR-70	S400 Jobsite™	Limited 15 Year	Level Head Rake	Forged 8-Tine	Ferrule	54" Hardwood	-	031365127132	6	9.6
7	60720 SK-70H	S400 Jobsite™	Limited 15 Year	Soil Knife	Forged 2" Head	Ferrule	15" Hardwood with Leather Thong	-	031365100401	6	4.8
8	60721 GC-70H	S400 Jobsite™	Limited 15 Year	Cultivator	Forged 2.5" Head	Ferrule	15" Hardwood with Leather Thong	-	031365127071	6	6
9	60725 WE-70H	S400 Jobsite™	Limited 15 Year	Dandelion Weeder	Forged 1"	Ferrule	15" Hardwood with Leather Thong	-	031365050362	6	4.8
10	60723 NT-70H	S400 Jobsite™	Limited 15 Year	Nursery Trowel	Forged 3.75" Head	Ferrule	15" Hardwood with Leather Thong	-	031365053189	6	7.2
11	60727 WH-70H	S400 Jobsite™	Limited 15 Year	Weeding Hoe	Forged 2.5" Head	Ferrule	15" Hardwood with Leather Thong	-	031365051253	6	4.8

PLANTING TOOLS



Our rugged all-steel planting mattocks and cultivators easily cut into hard soils allowing for fast setting of ground covers and bedding plants.

GARDEN HOE MATTOCKS
Combines a hoe blade with a mattock blade. They are used to chop, dig or grub.

#	SMW # LEGACY #	SERIES	DESCRIPTION	HEAD STYLE	HEAD-TO-HANDLE	HANDLE TYPE	GRIP	UPC	PACK QTY	PACK WEIGHT
1	41202	S550 Irrigation™	Planting Mattock	Tapering 2" - 1.25" Heavy-Duty Steel	Welded	14" Overall Length	Anti-Slip Vinyl	046385412021	6	23.4
2	41212	S550 Irrigation™	Bedding Mattock	14 Gauge 3" Shovel Style Head	Welded	14" Overall Length	Anti-Slip Vinyl	046385412120	6	18
3	41222	S550 Irrigation™	Cultivator and Mattock	3-Prong Cultivator & 1.25" Planting Head	Welded	14" Overall Length	Anti-Slip Vinyl	046385412229	1	39
4	85591	S400 Jobsite™	Tiller Mattock	1.5 lb		16" Fiberglass with Overstrike Protection	Cushion Grip	046385855910	2	3.6
5	85592	S400 Jobsite™	Pick Scoop	1.5 lb		16" Fiberglass with Overstrike Protection	Cushion Grip	046385855927	2	3.7
6	85590	S400 Jobsite™	Pick Mattock	1.5 lb		16" Fiberglass with Overstrike Protection	Cushion Grip	046385855903	2	3.6
7	85529 HM-949	S300 DuraLite™	Garden Hoe Mattock	3 lb		51" Hardwood	N/A	031365126098	6	22.8
8	41033 WP-5400	S300 DuraLite™	Hand Trowel	Chrome Plated 3.5" x 6"	Steel Collar	Hardwood	Hook Ready Handle	031365154008	12	6
9	41031 WP-5403	S300 DuraLite™	Hand Cultivator	Chrome Plated 3-Prong	Steel Collar	Hardwood	Hook Ready Handle	031365154039	12	4.8
10	41034 WP-5401	S300 DuraLite™	Hand Transplanter	Chrome Plated 2.5" x 6"	Steel Collar	Hardwood	Hook Ready Handle	031365154015	12	8.4
11	41035 WP-5402	S300 DuraLite™	Dandelion Weeder	Chrome Plated .75" x 2.5"	Steel Collar	Hardwood	Hook Ready Handle	031365154022	1	0.6
12	41040	S400 Jobsite™	Weeding Knife	6.5" Blade with Tapered Slicing Edge	Thumb Rest	4.5" Comfort Polymer Handle	Hook Ready Handle	046385410409	10	6
13	41041	S400 Jobsite™	Sheath for Weeding Knife	Five Rivets	Belt Loop	-	-	046385410416	12	2.4
13	41042	S400 Jobsite™	Weeding Knife with Sheath	6.5" Blade with Tapered Slicing Edge	Thumb Rest	4.5" Comfort Polymer Handle	Hook Ready Handle	046385410423	12	8.4

Building a better professional broom starts with our super-strong gusset bracing, the strongest head-to-handle connection on the market today. Choose from brooms for rough surfaces, smooth surfaces or "duo" models that combine bristles for all-purpose use. Our bent "ergonomic" aluminum handles provide more effective head-to-surface contact while promoting comfort and ease of use.



Our duo brooms have a highly effective sweeping action because of its strong inside bristles with outside bristles specifically designed to sweep the finest of materials.

#	SMW #	SERIES	WARRANTY	DESCRIPTION	HEAD STYLE	HEAD-TO-HANDLE	HANDLE TYPE	GRIP	UPC	PACK QTY	PACK WEIGHT
1	83728	S600 Power™	Limited Lifetime	Industrial Broom	28" Maximum Duty 3 Bristle Rows	Wrap-Around Bracing	60" Premium Fiberglass	ProGrip™	046385837282	1	6.1
1	82728	S600 Power™	Limited Lifetime	Industrial Broom	28" Maximum Duty 2 Bristle Rows	Wrap-Around Bracing	60" Premium Fiberglass	ProGrip™	046385827283	1	5.9
2	83928	S500 Industrial™	Limited Lifetime	Industrial Broom	28" Three Rows of 3" Bristles plus Scraping Edge	Wrap-Around Bracing	60" Ergonomic Powder-Coated Aluminum	Cushion	046385839286	1	6
2	82928	S500 Industrial™	Limited Lifetime	Industrial Broom	28" Two Rows of 3" Bristles plus Scraping Edge	Wrap-Around Bracing	60" Ergonomic Powder-Coated Aluminum	Cushion	046385829287	1	6
3	82106	S600 Power™	Limited Lifetime	Duo Broom	36" Heavy-Duty Duo Bristles	Gusset Bracing	60" Ergonomic Powder-Coated Aluminum	Cushion	046385821069	4	19.2
3	82104	S600 Power™	Limited Lifetime	Duo Broom	24" Heavy-Duty Duo Bristles	Gusset Bracing	60" Ergonomic Powder-Coated Aluminum	Cushion	046385821045	4	17.6
4	82706	S600 Power™	Limited Lifetime	Duo Broom	36" Heavy-Duty Duo Bristles	Gusset Bracing	60" Premium Fiberglass	ProGrip™	046385827061	4	22.8
4	82704	S600 Power™	Limited Lifetime	Duo Broom	24" Heavy-Duty Duo Bristles	Gusset Bracing	60" Premium Fiberglass	ProGrip™	046385827047	4	19.2
5	82906	S500 Industrial™	Limited Lifetime	Duo Broom	36" Heavy-Duty Duo Bristles	Gusset Bracing	60" Ergonomic Powder-Coated Aluminum	Cushion	046385829065	1	5.4
5	82904	S500 Industrial™	Limited Lifetime	Duo Broom	24" Heavy-Duty Duo Bristles	Gusset Bracing	60" Ergonomic Powder-Coated Aluminum	Cushion	046385829041	1	4.5
6	82905	S500 Industrial™	Limited Lifetime	Duo Broom	24" Heavy-Duty Duo Bristles	Gusset Bracing	60" Powder-Coated Aluminum	Cushion	046385829058	1	4
7	82902	S300 DuraLite™	Limited 5 Year	Duo Broom	24" Heavy-Duty Duo Bristles	Clamp Brace	Hardwood	-	046385829027	1	3.4

BROOMS - WONDER & GENERAL PURPOSE



1



2



3

82602 is an ideal combination broom for gardeners, landscapers and anyone wanting to move a heavy load as well as fine dust with the same broom.



82614 is for smooth and semi-smooth surfaces such as warehouse floors and cement. The best value for maintenance dollars spent.



82624 bristles are unaffected by chemicals, oils, or petroleum solvents. A top performing, best selling garage style broom.



4



5



6

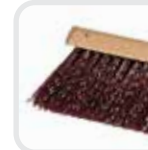

Our general purpose brooms use durable polypropylene bristles, firmly attached to a high quality hardwood shoulder.

#	SMW # LEGACY #	SERIES	WARRANTY	DESCRIPTION	HEAD STYLE	HEAD-TO- HANDLE	HANDLE TYPE	GRIP	UPC	PACK QTY	PACK WEIGHT
1	82602	S550 Irrigation™	Limited Lifetime	Wonder / Duo Broom	24" Heavy-Duty Duo Bristles	Gusset Bracing	60" Powder-Coated Aluminum	Cushion	046385826026	1	4
2	82614	S550 Irrigation™	Limited Lifetime	Wonder Broom	24" Medium Bristles	Gusset Bracing	60" Powder-Coated Aluminum	Cushion	046385826149	1	4
3	82624	S550 Irrigation™	Limited Lifetime	Wonder / General Purpose Broom	24" Heavy-Duty Bristles	Gusset Bracing	60" Powder-Coated Aluminum	Cushion	046385826248	1	4.2
4	82124	S600 Power™	Limited Lifetime	General Purpose Broom	24" Heavy-Duty Bristles	Gusset Bracing	60" Ergonomic Powder-Coated Aluminum	Cushion	046385821243	4	16.8
4	82136	S600 Power™	Limited Lifetime	General Purpose Broom	36" Heavy-Duty Bristles	Gusset Bracing	60" Ergonomic Powder-Coated Aluminum	Cushion	046385821366	4	22.4
5	82724	S600 Power™	Limited Lifetime	General Purpose Broom	24" Heavy-Duty Bristles	Gusset Bracing	60" Premium Fiberglass	ProGrip™	046385827245	4	19.2
5	82736	S600 Power™	Limited Lifetime	General Purpose Broom	36" Heavy-Duty Bristles	Gusset Bracing	60" Premium Fiberglass	ProGrip	046385827368	4	22.8
6	82926	S600 Power™	Limited Lifetime	General Purpose Broom	24" Heavy-Duty Bristles	Gusset Bracing	Collapsible Fiberglass Handle	ProGrip™	046385829263	1	5.5

GENERAL PURPOSE, PUSH & STREET - BROOMS



SA22106 - Blue Fiberglass Push Broom Handle
SA10096 - 18" Broom Head w/ adapter plate

#	SMW # LEGACY #	SERIES	WARRANTY	DESCRIPTION	HEAD STYLE	HEAD-TO-HANDLE	HANDLE TYPE	GRIP	UPC	PACK QTY	PACK WEIGHT
1	82924	S500 Industrial™	Limited Lifetime	General Purpose Broom	24" Heavy-Duty Bristles	Gusset Bracing	60" Ergonomic Powder-Coated Aluminum	Cushion	046385829249	1	4.2
2	82936	S500 Industrial™	Limited Lifetime	General Purpose Broom	36" Heavy-Duty Bristles	Gusset Bracing	60" Ergonomic Powder-Coated Aluminum	Cushion	046385829362	1	4.6
3	82925	S500 Industrial™	Limited Lifetime	General Purpose Broom	24" Heavy-Duty Bristles	Gusset Bracing	60" Powder-Coated Aluminum	Cushion	046385829256	1	4.4
4	82014 STR-PB24	S400 Jobsite™	Limited 15 Year	Push Broom	24" Medium Bristles for Smooth Surfaces	Wing-Nut and Bolt	60" Professional Grade Fiberglass	Cushion	036723003240	4	12.8
5	82008 STR-PB24R	S400 Jobsite™	Limited 15 Year	Push Broom	24" Head with 3" Medium Bristles for Rough Surfaces	Wing-Nut and Bolt	60" Professional Grade Fiberglass	Cushion	036723004247	4	12.8
6	82118	S600 Power™	Limited Lifetime	Street Broom	18" Head with 5" Stiff Bristles	Gusset Bracing	60" Ergonomic Powder-Coated Aluminum	Cushion	046385821182	4	17.6
7	82718	S600 Power™	Limited Lifetime	Street Broom	18" Head with 5" Stiff Bristles	Gusset Bracing	60" Premium Fiberglass	ProGrip™	046385827184	4	23.5

BROOMS - STREET, CORN AND STEEL



82918 & 82919 have stiff, extra-long bristles make this street broom an excellent choice when dealing with rough surfaces.

82918, 47026, 47025, & 47027 all have an ergonomic handles that are very comfortable to use & levels the bristle contact to the floor for maximized efficiency.



SA22106 - Blue Fiberglass Push Broom Handle
SA10096 - 18" Broom Head w/ Adapter Plate

47000 - Replacement Head for 47045 & 47025
47001 - Replacement Head for 47046 & 47026
47007 - Replacement Head for 47027 & 47037

#	SMW # LEGACY #	SERIES	WARRANTY	DESCRIPTION	HEAD STYLE	HEAD-TO-HANDLE	HANDLE TYPE	GRIP	UPC	PACK QTY	PACK WEIGHT
1	82918	S500 Industrial™	Limited Lifetime	Street Broom	18" Head 5" Stiff Bristles	Gusset Bracing	60" Ergonomic Powder-Coated Aluminum	Cushion	046385829188	1	5
2	82919	S500 Industrial™	Limited Lifetime	Street Broom	18" Head 5" Stiff Bristles	Gusset Bracing	60" Powder-Coated Aluminum	Cushion	046385829195	1	4.8
3	82018 STR-SB24R	S400 Jobsite™	Limited 15 Year	Street Broom	24" Head 4.5" Medium Bristles for Rough Surfaces	Wing-Nut and Bolt	60" Professional Grade Fiberglass	Cushion	036723006241	4	14.4
4	82500	S400 Jobsite™	Limited 15 Year	Corn Broom	Contractor Grade	Wire-Wrapped	Wood	-	046385825005	1	2.8
5	47046	S600 Power™	Limited Lifetime	Steel Wire Broom	16" Head 3.75" Round Steel Wires	Gusset Bracing	60" Premium Fiberglass	ProGrip™	046385470465	2	9.2
6	47045	S600 Power™	Limited Lifetime	Steel Wire Broom	12" Head 5" Flat Steel Wires	Gusset Bracing	60" Premium Fiberglass	ProGrip™	046385470458	2	8.8
7	47026	S550 Professional™	Limited Lifetime	Steel Wire Broom	16" Head 3.75" Round Steel Wires	Gusset Bracing	60" Ergonomic Powder-Coated Aluminum	Cushion	046385470267	1	5.2
8	47025	S550 Professional™	Limited Lifetime	Steel Wire Broom	12" Head 5" Flat Steel Wires	Gusset Bracing	60" Ergonomic Powder-Coated Aluminum	Cushion	046385470250	1	6
9	47027	S550 Professional™	Limited Lifetime	Steel Wire Broom	7.25" Head 1.625" Round Steel Wires	Gusset Bracing	60" Ergonomic Powder-Coated Aluminum	Cushion	046385470274	1	2.3
10	47037	S550 Professional™	Limited Lifetime	Steel Wire Broom	7.25" Head 1.625" Round Steel Wires	Gusset Bracing	60" Powder-Coated Aluminum	Cushion	046385470373	1	3

Our selection of brooms extends beyond traditional pavement-style brooms. We also offer specialty brooms for large-area pavement cleaning, athletic field dressing and brushes for applying pavement seal coating products. For additional cleaning solutions, also see our squeegee products.

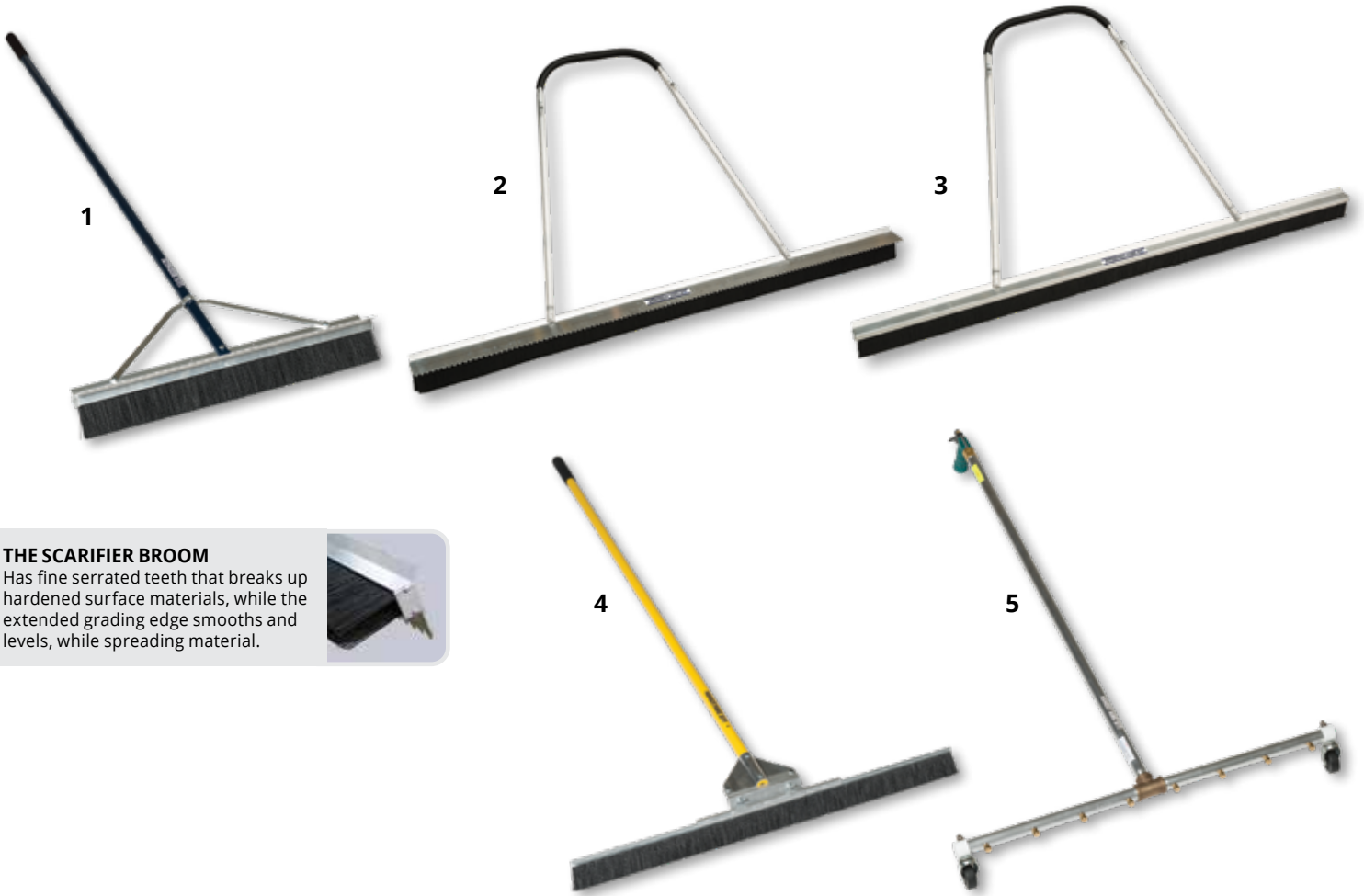

THE SCARIFIER BROOM

Has fine serrated teeth that breaks up hardened surface materials, while the extended grading edge smooths and levels, while spreading material.



#	SMW # LEGACY #	SERIES	WARRANTY	DESCRIPTION	HEAD STYLE	HEAD-TO-HANDLE	HANDLE TYPE	GRIP	UPC	PACK QTY	PACK WEIGHT
1	82328	S500 Industrial™	Limited Lifetime	Double Play Scarifier Broom	28" Head Two Rows of 3" Bristles	Wrap-Around Bracing	66" Powder-Coated Aluminum	Cushion	046385823285	1	5.4
1	83328	S500 Industrial™	Limited Lifetime	Double Play Scarifier Broom	28" Head Three Rows of 3" Bristles	Wrap-Around Bracing	66" Powder-Coated Aluminum	Cushion	046385833284	1	5.8
2	83384	S550 Professional™	Limited Lifetime	Monster Broom with Scarifier	7' Head Three Rows of 3.5" Bristles	Bolted A-Frame	Fluted Aluminum	Foam Grip	046385833840	1	16.6
2	82384	S550 Professional™	Limited Lifetime	Monster Broom with Scarifier	7' Head Two Rows of 3.5" Bristles	Bolted A-Frame	Fluted Aluminum	Foam Grip	046385823841	1	16.6
3	83084	S500 Industrial™	Limited Lifetime	Monster Broom	7' Head Three Rows of 3.5" Bristles	Bolted A-Frame	Fluted Aluminum	Foam Grip	046385830849	1	15
3	82084	S500 Industrial™	Limited Lifetime	Monster Broom	7' Head Two Rows of 3.5" Bristles	Bolted A-Frame	Fluted Aluminum	Foam Grip	046385820840	1	13.2
4	77036	S550 Professional™	Limited Lifetime	Sealing Broom	36" with 2.5" Flexible Poly Bristles	Gusset Bracing	66" Powder-Coated Aluminum	Cushion	046385770367	1	3.8
4	77136	S550 Professional™	Limited Lifetime	Sealing Broom	36" with 2.5" Flexible Poly Bristles (Head Only)	Gusset Bracing	Threaded Handle Adapter Kit SA30010	-	046385771364	1	2.6
5	46048	S550 Professional™	Limited Lifetime	Water Broom	48" 12 Nozzles with Caster Wheels	Brass T-Connector	Aluminum	Pistol Grip Hose-Connector	046385460480	2	10.4
5	46032	S550 Professional™	Limited Lifetime	Water Broom	32" 8 Nozzles with Caster Wheels	Brass T-Connector	Aluminum	Pistol Grip Hose-Connector	046385460329	1	4.6

SNOW TOOLS - BLIZZARD BUSTER® SHOVELS & PUSHERS

OUR BLIZZARD BUSTER® LINE OF SNOW TOOLS ARE THE BEST DEFENSE AGAINST OLD MAN WINTER!



SP16008 - 24" Black Polycarbonate Snow Pusher Replacement Head

#	SMW # LEGACY #	SERIES	WARRANTY	DESCRIPTION	HEAD STYLE	HEAD-TO-HANDLE	HANDLE TYPE	GRIP	UPC	PACK QTY	PACK WEIGHT
1	96829 STR-PS200	S600 Power™	Limited Lifetime	Snow Shovel	19" Black Polycarbonate	Two Hex-Screws	43" Premium Fiberglass	Poly D	036723114007	4	14.4
2	96849	S600 Safety™	Limited Lifetime	Snow Shovel	18" Polycarbonate	Two Hex-Screws	43" Premium Fiberglass	Poly D	046385968498	4	14.4
3	96827 STR-PSE200	S600 Power™	Limited Lifetime	Snow Shovel	18" Polycarbonate	Two Screws	34" Ergonomic Steel	Poly D	036723114021	4	16
4	96809 SV-SS20	S400 Jobsite™	Limited 15 Year	Snow Shovel	18" Polycarbonate	Hex-Screw	44" Precision Lathe Turned Hardwood	Poly D	031365123721	4	15.2
5	96838 STR-PP100	S600 Power™	Limited Lifetime	Snow Pusher	24" Polycarbonate	Two Hex-Screws in Braced Socket	45" Premium Fiberglass	Poly D	036723113000	4	15.2
6	96858	S600 Safety™	Limited Lifetime	Snow Pusher	24" Polycarbonate	Two Hex-Screws in Braced Socket	45" Premium Fiberglass	Poly D	046385968580	4	15.2
7	96818 SV-SP20	S400 Jobsite™	Limited 15 Year	Snow Pusher	24" Polycarbonate	Two Hex-Screws in Braced Socket	44" Precision Lathe Turned Hardwood	Poly D	031365123738	4	15.2

SLEIGH SCOOP, SNOW SQUEEGES & ROOF RAKES - SNOW TOOLS

SLEIGH SCOOP

- Large bucket for efficient snow removal.
- Designed for optimum comfort and efficiency
- Ideal for snow heavy removal
- Ideal for driveways, walkways and commercial areas
- Robust construction suitable for professional use
- Tested for use at -40° F
- Shaft: 36"
- Blade: 24" x 31"



1



2



3



4

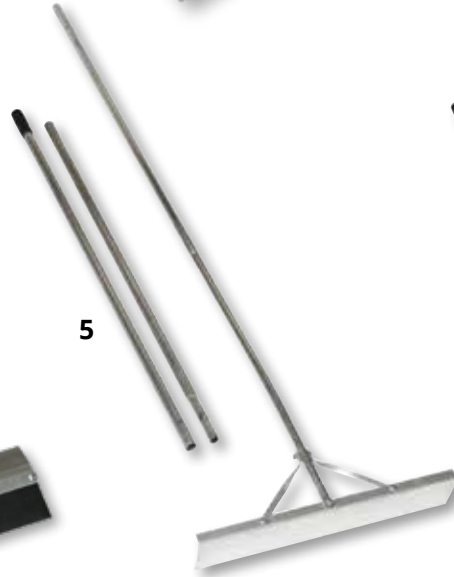

5



6

#	SMW # LEGACY #	SERIES	WARRANTY	DESCRIPTION	HEAD STYLE	HEAD-TO-HANDLE	HANDLE TYPE	GRIP	UPC	PACK QTY	PACK WEIGHT
1	96880	S400 Jobsite™	Limited 15 Year	Sleigh Scoop	Black, eco-friendly blade made with recycled Polyolefin	-	Black U-handle made from heat-treated powder coated steel	-	0772421002085	6	10.8
2	96806	S300 DuraLite™	Limited 5 Year	Snow Shovel	16.5" Poly	Two Screws	30" Vinyl Coated Steel	Poly D	031365968063	6	13.2
3	96817	S300 DuraLite™	Limited 5 Year	Snow Pusher	19.5" Polycarbonate	Two Screws	30" Vinyl Coated Steel	Poly D	031365968179	6	14.4
4	96624	S500 Industrial™	Limited Lifetime	24" Snow Squeegee	3" Replaceable Rubber	Wrap-Around Bracing	66" Powder-Coated Aluminum	Cushion	046385966241	12	50.4
4	96636	S500 Industrial™	Limited Lifetime	36" Snow Squeegee	3" Replaceable Rubber	Wrap-Around Bracing	66" Powder-Coated Aluminum	Cushion	046385966364	12	64.8
5	96022 RR-25	S500 Industrial™	Limited Lifetime	Roof Rake	24" Aluminum Blade	"Push-Pull" Bracing	16' 3-Section Aluminum	Cushion	046385960225	1	4.6
6	96322	S500 Industrial™	Limited Lifetime	Roof Rake	24" Aluminum Blade	"Push-Pull" Bracing	16' 4-Section Aluminum	Cushion	046385963226	1	4.8
-	96701	S500 Industrial™	-	Shingle Saver Sleeve	-	-	-	-	046385967019	1	0.5
-	96048	S500 Industrial™	-	4' Extension Handle, Bulk Assembled	-	-	-	-	046385960485	1	1.1
-	96148 RR-25EH	S500 Industrial™	-	4' Extension Handle, Individually Boxed	-	-	-	-	031365129143	1	28.0
-	96060	S500 Industrial™	-	5' Extension Handle	-	-	-	-	046385960607	1	1.2

IRRIGATION - SOIL PROBES, PLACERS & LIGHTING TRENCHERS



SOIL PROBE TIPS
Steel tips provide strength with light weight.

WIRE & SWING PIPE PLACER TIPS
The .75" hard nylon tip is non-conductive. It grips the cable to place it into the trench bottom.

GENEROUS STEPS
An all-steel tool for installing landscape lighting, irrigation line, landscape edging and more. The 4 gauge head is 8-1/4" wide and nearly 10" long with a 1-1/4" generous step.

ALL-STEEL CONSTRUCTION

- Heavy-duty 3/4" hex shaft
- Dig-out spike
- Steel leverage step
- Sure-grip handle
- 36" overall length

SA32003 - Soil Probe Repair Kit for 85465 & 85466

#	SMW # LEGACY #	SERIES	WARRANTY	DESCRIPTION	HEAD STYLE	HEAD-TO-HANDLE	HANDLE TYPE	GRIP	UPC	PACK QTY	PACK WEIGHT
1	85465 STR-SP48	S600 Power™	Limited Lifetime	Soil Probe	Cast Metal Pointed Tip	Industrial Grade Epoxy	48" Fiberglass	ProGrip™	036723009112	4	4.8
1	85466 STR-SP60	S600 Power™	Limited Lifetime	Soil Probe	Cast Metal Pointed Tip	Industrial Grade Epoxy	60" Fiberglass	ProGrip™	036723009136	4	5.6
2	85462	S550 Irrigation™	Limited Lifetime	Soil Probe	Solid Steel Tip	One Piece Mold	48" Length with 1/2" Shaft	T-Handle with Grips	046385854623	10	43.2
3	85468	S600 Power™	Limited Lifetime	Wire & Swing Pipe Placer	Nylon Placer Tip	Industrial Grade Epoxy	36" Fiberglass	ProGrip™	046385854685	4	5.6
3	85469	S600 Power™	Limited Lifetime	Wire & Swing Pipe Placer	Nylon Placer Tip	Industrial Grade Epoxy	48" Fiberglass	ProGrip™	046385854692	1	1.8
4	85310	S550 Irrigation™	Limited Lifetime	Manhole Lifter	Manhole Hook with Digout Spike	One-Piece Steel	36" Overall Length	Sure-Grip	046385853107	1	7.4
5	49045	S550 Irrigation™	Limited Lifetime	Lighting Trencher / Edger	4 Gauge Square Steel Head with Forward Turned Step	Welded	45" Solid Steel Handle	T-Handle with Caps	046385490456	1	12
6	49044	S550 Irrigation™	Limited Lifetime	Lighting Trencher / Edger	4 Gauge Square Steel Head with Forward Turned Step	Welded	48" Solid Steel Handle	-	046385490449	1	12.2

VALVE KEYS & WRENCHES - IRRIGATION



(A) 2" SQUARE KEY



(B) 1" VALVE KEY



(C) 1-1/8" METER KEY



(D) 1/2" METER KEY

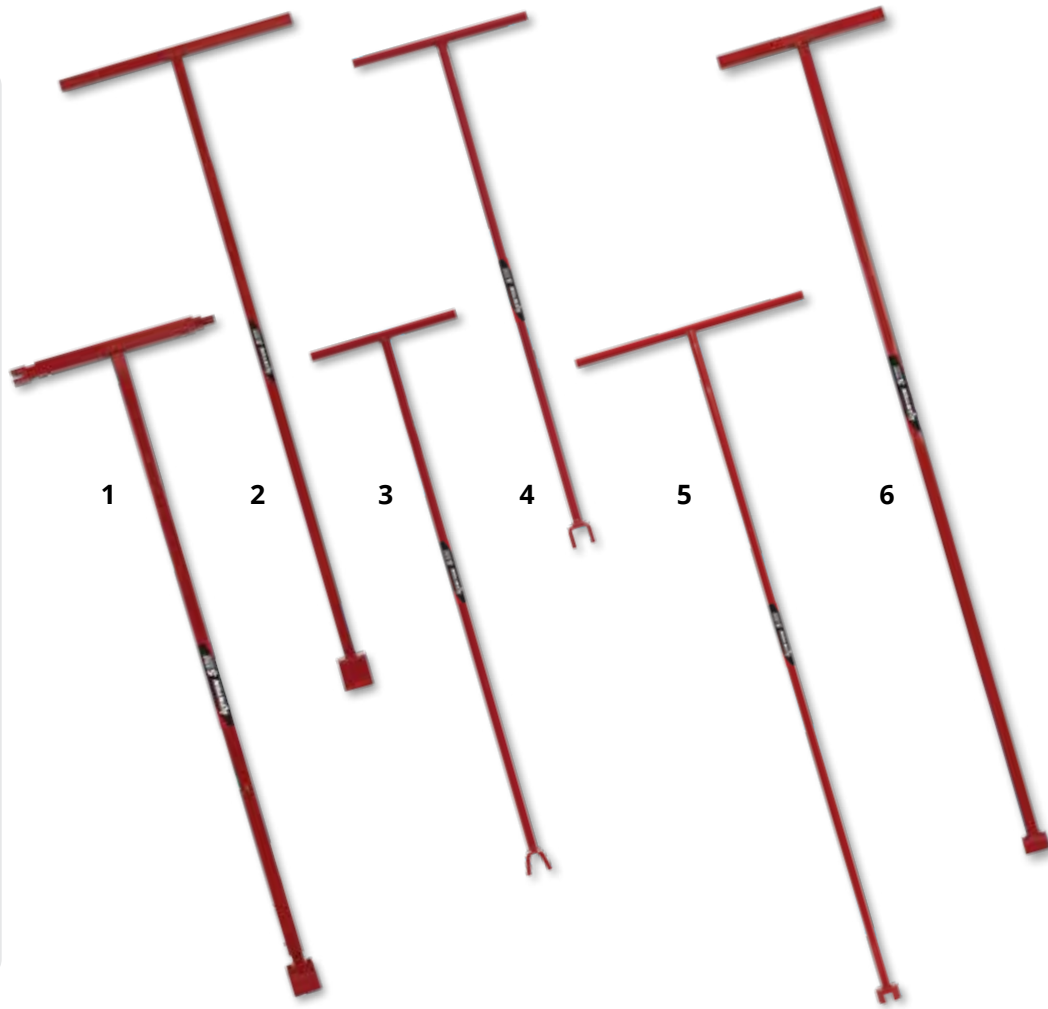

TIP FOR #2



TIP FOR #3



TIP FOR #4



TIP FOR #5



TIP FOR #6

RM60112 - Snap Button for Single Operating Wrench

#	SMW #	SERIES	WARRANTY	DESCRIPTION	HEAD STYLE	HEAD-TO-HANDLE	HANDLE LENGTH	GRIP	UPC	PACK QTY	PACK WEIGHT
1	85490	S550 Irrigation™	Limited Lifetime	Adjustable Operating Wrench	Uses A, B, D	Snap Pins to Square Steel	3' - 5' Steel	Welded T-Handle	046385854906	1	9.6
1	85491	S550 Irrigation™	Limited Lifetime	Adjustable Operating Wrench	Uses A, B, C	Snap Pins to Square Steel	3' - 5' Steel	Welded T-Handle	046385854913	1	9.6
1	85495	S550 Irrigation™	Limited Lifetime	Adjustable Operating Wrench	Uses A, B, D	Snap Pins to Square Steel	5' - 9' Steel	Welded T-Handle	046385854951	1	13.8
1	85496	S550 Irrigation™	Limited Lifetime	Adjustable Operating Wrench	Uses A, B, C	Snap Pins to Square Steel	5' - 9' Steel	Welded T-Handle	046385854968	1	13.8
-	SP50162	S550 Irrigation™	Limited Lifetime	Square Key (A)	Fits 2" Operating Nut	-	-	-	046385012245	1	1
-	SP50163	S550 Irrigation™	Limited Lifetime	Valve Key (B)	Fits 1" Opening	-	-	-	046385012252	1	1
-	SP50164	S550 Irrigation™	Limited Lifetime	Meter Key (C)	Fits 1-1/8" Opening	-	-	-	046385012269	1	1
-	SP50167	S550 Irrigation™	Limited Lifetime	Meter Key (D)	Fits 1/2" Opening	-	-	-	046385012276	1	1
2	85487	S550 Irrigation™	Limited Lifetime	Operating Wrench	2" x 2" for Square Nuts	One-Piece Steel	60" Steel	Welded T-Handle	046385854876	6	24
3	85450	S550 Irrigation™	Limited Lifetime	30" Meter Key	3/4" Groove Width	One-Piece Steel	30" Steel	Welded T-Handle	046385854500	1	48
4	85484	S550 Irrigation™	Limited Lifetime	28" Meter Key	0.8" Opening	One-Piece Steel	28" Steel	Welded T-Handle	046385854845	1	20
5	85452	S550 Irrigation™	Limited Lifetime	32" Heavy-Duty Meter Key	5/8" Groove Width	One-Piece Steel	32" Steel	Welded T-Handle	046385854524	6	38.4
5	85455	S550 Irrigation™	Limited Lifetime	60" Heavy-Duty Meter Key	5/8" Groove Width	One-Piece Steel	60" Steel	Welded T-Handle	046385854555	4	42.4
6	85486	S550 Irrigation™	Limited Lifetime	32" Meter Key	1-1/8" Opening	One-Piece Steel	32" Steel	Welded T-Handle	046385854869	1	30.4
6	85499	S550 Irrigation™	Limited Lifetime	6' Meter Key	1-1/8" Opening	One-Piece Steel	6' Steel	Welded T-Handle	046385854999	1	10

IRRIGATION - SPRINKLER VALVE & HEAD TRIMMERS

A security valve key or bib wrench - opens & closes water valves without hand wheels/turn on handles for security reasons. Fittings for 1/4", 9/32", 5/16" and 11/32".



SA22034 - Replacement Handle for Drain Cleaner

#	SMW # LEGACY #	SERIES	WARRANTY	DESCRIPTION	HEAD DESCRIPTION	HANDLE DESCRIPTION	HANDLE TYPE	GRIP	UPC	PACK QTY	PACK WEIGHT
1	85481	S550 Irrigation™	Limited Lifetime	Security Key	4-Way Water Valve Key	Fittings for 1/4", 9/32", 5/16", & 11/32"	-	-	046385854814	1	0.5
2	85480	S550 Irrigation™	Limited Lifetime	Sprinkler Key	-	7" Overall Length	-	-	046385854807	1	0.3
3	85482	S550 Irrigation™	Limited Lifetime	Sprinkler Key	-	30" Overall Length	One Piece Steel	Hand Grip	046385854821	1	16
4	85485	S550 Irrigation™	Limited Lifetime	Heavy-Duty Sprinkler & Valve Key	-	48" Overall Length	One Piece Heavy-Duty Steel	T-Handle	046385854852	1	36.8
5	85483	S550 Irrigation™	Limited Lifetime	Sprinkler Key	-	54" Overall Length	One Piece Steel	T-Handle	046385854838	1	24
6	41250	S550 Irrigation™	Limited Lifetime	EZ Out Broken Pipe Riser Extractor	.5" & .75"	One-Piece Steel	-	Welded T-Handle	046385412502	1	12
6	41251	S550 Irrigation™	Limited Lifetime	EZ Out Broken Pipe Riser Extractor	1" & 1.25"	One-Piece Steel	-	Welded T-Handle	046385412519	1	10.4
7	41255	S550 Irrigation™	Limited Lifetime	EZ Out Broken Pipe Riser Extractor	.5" & .75" Aluminum Head	One-Piece Steel	-	Hand Grip	046385412557	1	4
8	21504 DR-DC4	S500 Industrial™	Limited Lifetime	Drain Cleaner	15" x 4" Steel Head	Solid Steel Rivet with Ferrule	72" Precision Lathe Turned American Hardwood	-	031365030104	2	12.4
8	21505 DR-DC5	S500 Industrial™	Limited Lifetime	Drain Cleaner	15" x 5" Steel Head	Solid Steel Rivet with Ferrule	72" Precision Lathe Turned American Hardwood	-	031365030203	2	13.4
9	85422	S550 Irrigation™	Limited Lifetime	Sprinkler Head Trimmer	2-3/4" Diameter with Step Plate	Welded 33" Overall Length	5/8" Powder-Coated Structural Steel	T-Handle	046385854227	6	28.8
9	85423	S550 Irrigation™	Limited Lifetime	Sprinkler Head Trimmer	3-1/2" Diameter with Step Plate	Welded 33" Overall Length	5/8" Powder-Coated Structural Steel	T-Handle	046385854234	6	28.8
9	85424	S550 Irrigation™	Limited Lifetime	Sprinkler Head Trimmer	4" Diameter with Step Plate	Welded 33" Overall Length	5/8" Powder-Coated Structural Steel	T-Handle	046385854241	6	30
9	85426	S550 Irrigation™	Limited Lifetime	Sprinkler Head Trimmer	6" Diameter with Step Plate	Welded 33" Overall Length	5/8" Powder-Coated Structural Steel	T-Handle	046385854265	4	23.2
9	85427	S550 Irrigation™	Limited Lifetime	Sprinkler Head Trimmer	7" Diameter with Step Plate	Welded 33" Overall Length	5/8" Powder-Coated Structural Steel	T-Handle	046385854272	4	24
9	85428	S550 Irrigation™	Limited Lifetime	Sprinkler Head Trimmer	8" Diameter with Step Plate	Welded 33" Overall Length	5/8" Powder-Coated Structural Steel	T-Handle	046385854289	2	13.2
9	85430	S550 Irrigation™	Limited Lifetime	Sprinkler Head Trimmer	10" Diameter with Step Plate	Welded 33" Overall Length	5/8" Powder-Coated Structural Steel	T-Handle	046385854302	2	14.4

KENYON PROGRADE MEASURING WHEEL

- Heavy-duty 3/4" steel tube frame and handle
- Wheel is positioned in the center of frame
- Folds in half for storage and portability
- 5 digit, easy-to-read counter
- Comes with mud scraper

KENYON SMALL TELESCOPING MEASURING WHEEL

- Fits in a toolbox or briefcase
- Geared counter
- Adds while rolling forward and subtracts when pulled in reverse
- Weights less than 2 pounds



KENYON GROUNDSCAPERS

- Molded ABS wheel
- Telescopic metal handle with kickstand
- Geared counter
- Lightweight and durable

KENYON WIDE-TRAK MEASURING WHEEL

- Solid and wider wheel for excellent balance
- Heavy-duty 3/4" steel handle
- 5 digit, easy-to-read counter

SP50360 - Replacement Counter for 85713 & 85714

#	SMW #	SERIES	WARRANTY	DESCRIPTION	CIRCUMFERENCE	CAPACITY	HANDLE TYPE	GRIP	UPC	PACK QTY	PACK WEIGHT
1	85713	S550 Irrigation™	Limited Lifetime	Measuring Wheel	3' Circumference	Up to 99,999 Ft.	Foldable Steel with Kickstand	Hanging Tip	046385857136	1	5.4
1	85714	S550 Irrigation™	Limited Lifetime	Measuring Wheel	4' Circumference	Up to 99,999 Ft.	Foldable Steel with Kickstand	Hanging Tip	046385857143	1	6.2
2	85703	S550 Irrigation™	Limited Lifetime	Measuring Wheel	3' Circumference	Up to 9,999 Ft.	Telescoping Metal with Kickstand	Ergonomic	046385857037	1	2.6
2	85704	S550 Irrigation™	Limited Lifetime	Measuring Wheel	4' Circumference	Up to 9,999 Ft.	Telescoping Metal with Kickstand	Ergonomic	046385857044	1	4.9
3	85701	S550 Irrigation™	Limited Lifetime	Measuring Wheel	1' Circumference	Up to 9,999 Ft.	17" - 38" Telescoping	Hanging Tip	046385857013	1	0.6
4	85712	S550 Irrigation™	Limited Lifetime	Measuring Wheel	2' Circumference	Up to 99,999 Ft.	Heavy-Duty Steel Handle	Hanging Tip	046385857129	1	4.7
5	41050	S550 Irrigation™	Limited Lifetime	Tape Measure	1" x 25' Tape	Push Button Lock	-	-	046385410508	24	21.6

IRRIGATION - SAWS, CUTTERS & WRENCHES



NEW PRODUCTS - 41606, 41608, 41616, 41618

SP13305 - 18" Replacement Blade for 41446
 SP13300 - 6" x 1/2" Replacement Blades for 41440
 SP13301 - 1-5/8" Replacement Blade for 41430
 SP13302 - 2" Replacement Blade for 41432
 SP13303 - Pipe & Hose Replacement Blade for 41434

#	SMW #	SERIES	WARRANTY	DESCRIPTION	HEAD DESCRIPTION	USAGE	APPLICATION	GRIP	UPC	PACK QTY	PACK WEIGHT
1	41446	S550 Irrigation™	Limited Lifetime	PVC Saw	18" Replaceable Blade	Designed to Cut PVC, CPVC, ABS & Plastic Drainage Pipe	-	Hand Grip	046385414469	12	11.0
2	41444	S550 Irrigation™	Limited Lifetime	Box Saw	14" Flexible Blade	General Purpose	-	Hand Grip	046385414445	12	4.8
3	41440	S550 Irrigation™	Limited Lifetime	Mini Hacksaw	6" Replaceable Blade	Cuts Metal or Plastic Pipe	-	-	046385414407	1	0.4
4	41448	S550 Irrigation™	Limited Lifetime	Cable Saw	36" Cable Blade	Designed to Cut PVC, CPVC, ABS & Plastic Drainage Pipe	Good for Tight Spaces	T-Handles	046385414483	1	0.2
5	41430	S550 Irrigation™	Limited Lifetime	PVC Pipe Cutter	1-5/8" Capacity Replaceable Blade	Ratchet Action Cuts CL200 or SCH 40 PVC	Handle Lock for Safety	Vinyl	046385414308	12	13.2
5	41432	S550 Irrigation™	Limited Lifetime	PVC Pipe Cutter	2" Capacity Replaceable Blade	Ratchet Action Cuts CL200 or SCH 40 PVC	Handle Lock for Safety	Vinyl	046385414322	10	18
6	41436	S550 Irrigation™	Limited Lifetime	PVC Pipe Cutter	2" Capacity	Ratchet Action Cuts PVC Pipe	-	-	046385414360	6	6.6
7	41434	S550 Irrigation™	Limited Lifetime	Pipe & Hose Cutter	1/8" - 1-3/8" Capacity Replaceable Blade	Cuts Poly Pipe, Hose, & Drip Tubing	Unique Spring-Loaded Design	-	046385414346	1	0.6
8	41610	S550 Irrigation™	Limited Lifetime	Pipe Wench	Adjustable Aluminum Pipe Wrench	14" Overall Length	-	-	046385416104	24	43.2
8	41612	S550 Irrigation™	Limited Lifetime	Pipe Wench	Adjustable Aluminum Pipe Wrench	18" Overall Length	-	-	046385416128	12	36
8	41614	S550 Irrigation™	Limited Lifetime	Pipe Wench	Adjustable Aluminum Pipe Wrench	24" Overall Length	-	-	046385416142	10	48
8	41616	S550 Irrigation™	Limited Lifetime	Pipe Wench	Adjustable Aluminum Pipe Wrench	36" Overall Length	-	-	046385416166	4	44
8	41618	S550 Irrigation™	Limited Lifetime	Pipe Wench	Adjustable Aluminum Pipe Wrench	48" Overall Length	-	-	046385416180	2	38
9	41600	S550 Irrigation™	Limited Lifetime	Pipe Wench	Adjustable Steel Pipe Wrench	14" Overall Length	-	-	046385416005	24	62.4
9	41602	S550 Irrigation™	Limited Lifetime	Pipe Wench	Adjustable Steel Pipe Wrench	18" Overall Length	-	-	046385416029	6	24
9	41604	S550 Irrigation™	Limited Lifetime	Pipe Wench	Adjustable Steel Pipe Wrench	24" Overall Length	-	-	046385416043	6	36
9	41606	S550 Irrigation™	Limited Lifetime	Pipe Wench	Adjustable Steel Pipe Wrench	36" Overall Length	-	-	046385416067	4	47.4
9	41608	S550 Irrigation™	Limited Lifetime	Pipe Wench	Adjustable Steel Pipe Wrench	48" Overall Length	-	-	046385416081	2	42



SP50068 - 28" Replacement Bristles for Max Duty/Industrial/Double Play Scarifier Broom

#	SMW #	SERIES	WARRANTY	DESCRIPTION	HEAD STYLE	HEAD-TO-HANDLE	HANDLE TYPE	GRIP	UPC	PACK QTY	PACK WEIGHT
1	12524	S550 Professional™	Limited Lifetime	Dual Purpose Rake	24" Heavy-Duty Aluminum	Wrap-Around Bracing	66" Powder-Coated Aluminum	Cushion	046385125242	1	3.4
1	12536	S550 Professional™	Limited Lifetime	Dual Purpose Rake	36" Heavy-Duty Aluminum	Wrap-Around Bracing	66" Powder-Coated Aluminum	Cushion	046385125365	1	4
2	12024	S550 Professional™	Limited Lifetime	Field/Aggregate Rake	24" Heavy-Duty Aluminum	Wrap-Around Bracing	66" Powder-Coated Aluminum	Cushion	046385120247	12	50.4
2	12030	S550 Professional™	Limited Lifetime	Field/Aggregate Rake	30" Heavy-Duty Aluminum	Wrap-Around Bracing	66" Powder-Coated Aluminum	Cushion	046385120308	12	46.8
2	12036	S550 Professional™	Limited Lifetime	Field/Aggregate Rake	36" Heavy-Duty Aluminum	Wrap-Around Bracing	66" Powder-Coated Aluminum	Cushion	046385120360	12	63.6
2	12042	S550 Professional™	Limited Lifetime	Field/Aggregate Rake	42" Heavy-Duty Aluminum	Wrap-Around Bracing	66" Powder-Coated Aluminum	Cushion	046385120421	12	66
2	12048	S550 Professional™	Limited Lifetime	Field/Aggregate Rake	48" Heavy-Duty Aluminum	Wrap-Around Bracing	66" Powder-Coated Aluminum	Cushion	046385120483	12	72
3	51924	S550 Professional™	Limited Lifetime	Super Scraper	24" Aluminum	Wrap-Around Bracing	66" Powder-Coated Aluminum	Cushion	046385519249	12	3.8
3	51936	S550 Professional™	Limited Lifetime	Super Scraper	36" Aluminum	Wrap-Around Bracing	66" Powder-Coated Aluminum	Cushion	046385519362	12	4.4
4	12501	S550 Professional™	Limited Lifetime	Baserunner Field Rake	24" Heavy-Duty Aluminum	Gusset Bracing	39" - 70" Telescoping Fiberglass SuperHandle®	ProGrip™	046385125013	1	3.4
4	12502	S550 Professional™	Limited Lifetime	Baserunner Field Rake	30" Heavy-Duty Aluminum	Gusset Bracing	39" - 70" Telescoping Fiberglass SuperHandle®	ProGrip™	046385125020	1	3.8
4	12503	S550 Professional™	Limited Lifetime	Baserunner Field Rake	36" Heavy-Duty Aluminum	Gusset Bracing	39" - 70" Telescoping Fiberglass SuperHandle®	ProGrip™	046385125037	1	4.2
5	11024	S550 Professional™	Limited Lifetime	Screening Rake	24" Heavy-Duty Aluminum	Wrap-Around Bracing	66" Powder-Coated Aluminum	Cushion	046385110248	12	38.4
5	11030	S550 Professional™	Limited Lifetime	Screening Rake	30" Heavy-Duty Aluminum	Wrap-Around Bracing	66" Powder-Coated Aluminum	Cushion	046385110309	12	51.6
5	11036	S550 Professional™	Limited Lifetime	Screening Rake	36" Heavy-Duty Aluminum	Wrap-Around Bracing	66" Powder-Coated Aluminum	Cushion	046385110361	12	55.2
5	11042	S550 Professional™	Limited Lifetime	Screening Rake	42" Heavy-Duty Aluminum	Wrap-Around Bracing	66" Powder-Coated Aluminum	Cushion	046385110422	12	5.1
5	11048	S550 Professional™	Limited Lifetime	Screening Rake	48" Heavy-Duty Aluminum	Wrap-Around Bracing	66" Powder-Coated Aluminum	Cushion	046385110484	12	70.8
6	52936	S550 Professional™	Limited Lifetime	Scarifier Lute	36" Heavy-Duty Aluminum with Serrated Teeth	Wrap-Around Bracing	66" Powder-Coated Aluminum	Cushion	046385529361	12	50.4
7	56923	S550 Professional™	Limited Lifetime	ProTurf Lute	24" Heavy-Duty Aluminum	Wrap-Around Bracing	66" Powder-Coated Aluminum	Cushion	046385569237	12	3.2
7	56924	S550 Professional™	Limited Lifetime	ProTurf Lute	24" Heavy-Duty Aluminum	Wrap-Around Bracing	82" Powder-Coated Aluminum	Cushion	046385569244	12	43.2
7	56929	S550 Professional™	Limited Lifetime	ProTurf Lute	30" Heavy-Duty Aluminum	Wrap-Around Bracing	66" Powder-Coated Aluminum	Cushion	046385569299	12	45.6
7	56930	S550 Professional™	Limited Lifetime	ProTurf Lute	30" Heavy-Duty Aluminum	Wrap-Around Bracing	82" Powder-Coated Aluminum	Cushion	046385569305	12	48
7	56935	S550 Professional™	Limited Lifetime	ProTurf Lute	36" Heavy-Duty Aluminum	Wrap-Around Bracing	66" Powder-Coated Aluminum	Cushion	046385569350	12	48
7	56936	S550 Professional™	Limited Lifetime	ProTurf Lute	36" Heavy-Duty Aluminum	Wrap-Around Bracing	82" Powder-Coated Aluminum	Cushion	046385569367	12	52.8

SPORTS FIELD TOOLS



Ergonomic handles are very comfortable to use and levels the bristle contact to the floor for maximized efficiency.

SP50067 - 84" Replacement Bristles for Drag Broom
 SP50068 - 28" Replacement Bristles for Max Duty/Industrial/Double Play Scarifier Broom

#	SMW #	SERIES	WARRANTY	DESCRIPTION	HEAD STYLE	HEAD-TO-HANDLE	HANDLE TYPE	GRIP	UPC	PACK QTY	PACK WEIGHT
1	82925	S500 Industrial™	Limited Lifetime	General Purpose Broom	24" Durable Bristles	Gusset Bracing	60" Powder-Coated Aluminum	Cushion	046385829256	1	4.4
2	82384	S550 Professional™	Limited Lifetime	Monster Broom with Scarifier	7' Head Two Rows of 3.5" Bristles	Bolted A-Frame	Fluted Aluminum	Foam Grip	046385823841	1	16.6
2	83384	S550 Professional™	Limited Lifetime	Monster Broom with Scarifier	7' Head Three Rows of 3.5" Bristles	Bolted A-Frame	Fluted Aluminum	Foam Grip	046385833840	1	16.6
3	82084	S500 Industrial™	Limited Lifetime	Monster Broom	7' Head Two Rows of 3.5" Bristles	Bolted A-Frame	Grooved Aluminum	Foam Pad	046385820840	1	13.2
3	83084	S500 Industrial™	Limited Lifetime	Monster Broom	7' Head Three Rows of 3.5" Bristles	Bolted A-Frame	Grooved Aluminum	Foam Pad	046385830849	1	15
4	52917	S550 Professional™	Limited Lifetime	Mound & Plate Shaper	17" Heavy-Duty Aluminum	Gusset Bracing	66" Powder-Coated Aluminum	Cushion	046385529170	12	33.6
5	70936	S550 Professional™	Limited Lifetime	Roller Squeegee	36" Non-Absorbent	Wrap-Around Bracing	60" Ergonomic Powder-Coated Aluminum	Cushion	046385709367	1	5.6
6	70948	S550 Professional™	Limited Lifetime	Roller Squeegee	48" Non-Absorbent	Wrap-Around Bracing	60" Ergonomic Powder-Coated Aluminum	Cushion	046385709480	1	6.6

EASYSQUEEGEE®

CLEANABLE & REUSABLE US PATENT 10,165,923

PRECISION APPLICATION SQUEEGEE SYSTEM

FINALLY A TRULY CLEANABLE & REUSABLE PRECISION APPLICATION SQUEEGEE SYSTEM

The **self-locating & self-leveling** blades ensure your blade is straight, level and in perfect contact with the floor every time.

The eight unique engineered blades provide a level of versatility and jobsite application options not currently available from any competitive application squeegee tool today.

Cured Coatings Release technology ensures the frame is reusable regardless of the material (Epoxy and Urethanes) you're putting down with the **EasySqueegee®**, once cured the frame can be cleaned.

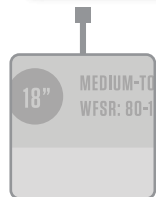
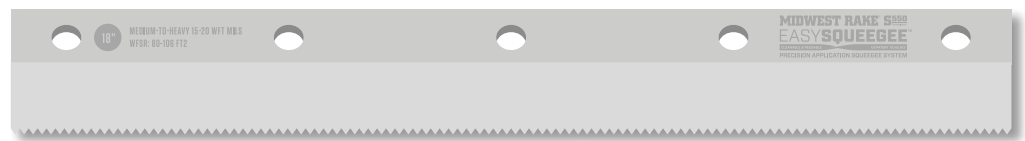

INTELLIGENT BLADE IDENTIFICATION
All blades inscribed with WFT and WFSR information.



SELF-LEVELING BLADES
Accurate and predictable Wet Film Thickness every time.



SELF-LOCATING BLADES
Designed to provide industry leading accuracy.



PROTECTED THREADS AND FASTENERS
Eliminates material contact with threads.



THUMB SCREWS REPLACE NUTS
Features Cured Coatings Release Technology for cleanability.

Wet Film Spread Rates (WFSR FT² / Gal.) are not absolute but provided to assist blade selection. Many factors can contribute to the actual WFSR including pressure exerted on the blade, porosity of the substrate being coated, material used and if and how the back-roll is completed. If you have any questions or would like to discuss the particulars of your project please contact us.

SMW #	BRAND	SERIES	DESCRIPTION	UPC	PACK QTY	PACK WEIGHT
78255	Midwest Rake®	S550 Professional™	18" EasySqueegee® Frame with Threaded Handle Adapter	046385782551	1	15.0
78256	Midwest Rake®	S550 Professional™	26" EasySqueegee® Frame with Threaded Handle Adapter	046385782568	1	21.0
79850	Midwest Rake®	S550 Professional™	19" EasySqueegee® with Flat Flexible Blade	046385798507	1	19.2
79851	Midwest Rake®	S550 Professional™	27" EasySqueegee® with Flat Flexible Blade	046385798514	1	27.8
79853	Midwest Rake®	S550 Professional™	18" EasySqueegee® with Flat Stiff Blade	046385798538	1	16.8
79854	Midwest Rake®	S550 Professional™	26" EasySqueegee® with Flat Stiff Blade	046385798545	1	24.5
79856	Midwest Rake®	S550 Professional™	18" EasySqueegee® with 5-7 WFT Mils Blade	046385798569	1	15.6
79857	Midwest Rake®	S550 Professional™	26" EasySqueegee® with 5-7 WFT Mils Blade	046385798576	1	22.6
79859	Midwest Rake®	S550 Professional™	18" EasySqueegee® with 8-12 WFT Mils Blade	046385798590	1	15.6
79860	Midwest Rake®	S550 Professional™	26" EasySqueegee® with 8-12 WFT Mils Blade	046385798606	1	22.6
79862	Midwest Rake®	S550 Professional™	18" EasySqueegee® with 15-20 WFT Mils Blade	046385798620	1	15.6
79863	Midwest Rake®	S550 Professional™	26" EasySqueegee® with 15-20 WFT Mils Blade	046385798637	1	22.6
79865	Midwest Rake®	S550 Professional™	18" EasySqueegee® with 25-30 WFT Mils Blade	046385798651	1	15.6
79866	Midwest Rake®	S550 Professional™	26" EasySqueegee® with 25-30 WFT Mils Blade	046385798668	1	22.6
79868	Midwest Rake®	S550 Professional™	18" EasySqueegee® with 40-45 WFT Mils Blade	046385798682	1	15.6
79869	Midwest Rake®	S550 Professional™	26" EasySqueegee® with 40-45 WFT Mils Blade	046385798699	1	22.6
79871	Midwest Rake®	S550 Professional™	18" EasySqueegee® with 50-60 WFT Mils Blade	046385798712	1	15.6
79872	Midwest Rake®	S550 Professional™	26" EasySqueegee® with 50-60 WFT Mils Blade	046385798729	1	22.6
79849	Midwest Rake®	S550 Professional™	Replacement Fasteners for EasySqueegee® (Bag of 7)	046385798491	1	4.5

SURESPIKES™

SIMPLE CHANGES... **BIG DIFFERENCE!**

Our new **SURESPIKES™** spiked shoes are certain to become the industry standard when compared to competitive "one-size-fits-all" polypropylene footwear available today.



CUSTOMER TESTIMONIAL:

I would like to tell how great the SURESPIKES™ perform for me. I was coating a floor that already had a trowel down epoxy installed. The new coating was to apply a full flake epoxy floor over what was already installed. I put on a slip-on spike as I normally do and started squeegeeing the epoxy. I noticed that I was slipping and sliding on the floor. The slip-on spikes work fine when the concrete doesn't have a previous coating. I felt unsafe to continue so I stopped my application and put on the SURESPIKES™ and my slipping stopped.

I was able to continue the process of squeegeeing with another person back-rolling and I was able to walk back out to broadcast the flake without any slipping. The SURESPIKES™ made it safe for me to install this floor.

- Bill J, Minnesota



ANGLED SPIKES PROVIDE MORE STABILITY AND DECREASE THE CHANCES OF SLIPPING & FALLING (PATENT PENDING)



1-INCH HARDENED STEEL SPIKES AND NYLOC NUTS PROVIDE IMPROVED DURABILITY AND SPIKES STAY SHARPER LONGER



TOE SPIKES PREVENT THE TIP OF THE SHOE FROM CONTACTING THE FLOOR

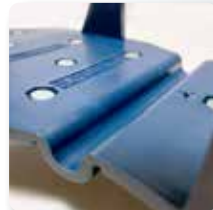

FLEXIBLE LIVING HINGE PROVIDES COMFORT & FLEXIBILITY



TUG & SNUG RUBBER STRAPS ARE QUICK, EASY, AND EFFICIENT WHEN COMPARED TO CLOTH STRAPS AND BUCKLES



"ONE-SIZE-FITS-ALL" IS PROVEN TO FIT ALMOST ANY SIZE SHOE OR BOOT

SMW #	DESCRIPTION	UPC	PACK QTY
46195	SURESPIKES™ Spiked Shoe	046385461951	6
46198	Replacement Spikes for 46195 (Set of 28 - 14 for Each Shoe)	046385461982	1
46199	Replacement Straps for 46195 (Set of 4 - 2 for Each Shoe)	046385461999	1



NEW**SPEEDSQUEEGEE™ HD - SQUEEGEES**

SPEEDSQUEEGEE HD™

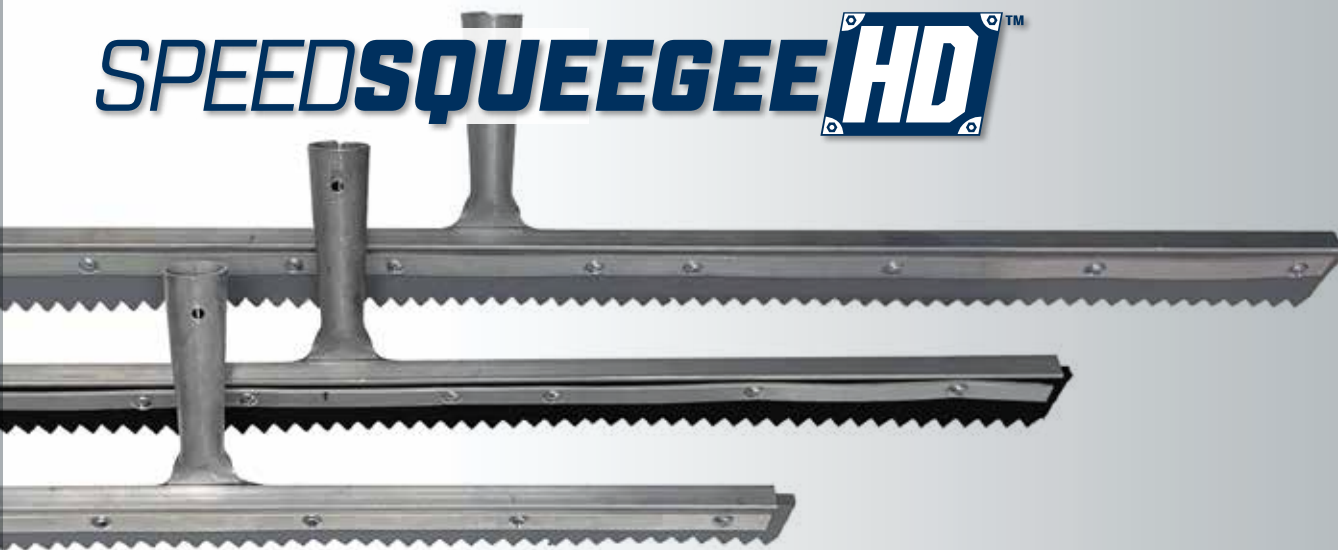
**TAPERED HANDLE ADAPTER****HEAVY-DUTY RUBBER BLADE**

SMW #	DESCRIPTION	PACK QTY
47511-B	SpeedSqueegee HD™, 24", Tapered Adapter, Flat, Black Rubber	6
47511-B8	SpeedSqueegee HD™, 24", Tapered Adapter, 1/8" W x 1/16" D (8-12 Mil), Black Rubber	6
47511-B15	SpeedSqueegee HD™, 24", Tapered Adapter, 3/16" W x 3/32" D (15-20 Mil), Black Rubber	6
47511-B20	SpeedSqueegee HD™, 24", Tapered Adapter, 1/4" W x 1/8" D (20-28 Mil), Black Rubber	6
47511-B30	SpeedSqueegee HD™, 24", Tapered Adapter, 3/8" W x 1/4" D (30-45 Mil), Black Rubber	6
47511-B46	SpeedSqueegee HD™, 24", Tapered Adapter, 1/2" W x 3/8" D (46-55 Mil), Black Rubber	6
47511-B56	SpeedSqueegee HD™, 24", Tapered Adapter, (56-74 Mil), Black Rubber	6
47511-B75	SpeedSqueegee HD™, 24", Tapered Adapter, (75+ Mil), Black Rubber	6
47511-G	SpeedSqueegee HD™, 24", Tapered Adapter, Flat, Gray Rubber	6
47511-G8	SpeedSqueegee HD™, 24", Tapered Adapter, 1/8" W x 1/16" D (8-12 Mil), Gray Rubber	6
47511-G15	SpeedSqueegee HD™, 24", Tapered Adapter, 3/16" W x 3/32" D (15-20 Mil), Gray Rubber	6
47511-G20	SpeedSqueegee HD™, 24", Tapered Adapter, 1/4" W x 1/8" D (20-28 Mil), Gray Rubber	6
47511-G30	SpeedSqueegee HD™, 24", Tapered Adapter, 3/8" W x 1/4" D (30-45 Mil), Gray Rubber	6
47511-G46	SpeedSqueegee HD™, 24", Tapered Adapter, 1/2" W x 3/8" D (46-55 Mil), Gray Rubber	6
47511-G56	SpeedSqueegee HD™, 24", Tapered Adapter, (56-74 Mil), Gray Rubber	6
47511-G75	SpeedSqueegee HD™, 24", Tapered Adapter, (75+ Mil), Gray Rubber	6
47512-B	SpeedSqueegee HD™, 30", Tapered Adapter, Flat, Black Rubber	6
47512-B8	SpeedSqueegee HD™, 30", Tapered Adapter, 1/8" W x 1/16" D (8-12 Mil), Black Rubber	6
47512-B15	SpeedSqueegee HD™, 30", Tapered Adapter, 3/16" W x 3/32" D (15-20 Mil), Black Rubber	6
47512-B20	SpeedSqueegee HD™, 30", Tapered Adapter, 1/4" W x 1/8" D (20-28 Mil), Black Rubber	6
47512-B30	SpeedSqueegee HD™, 30", Tapered Adapter, 3/8" W x 1/4" D (30-45 Mil), Black Rubber	6
47512-B46	SpeedSqueegee HD™, 30", Tapered Adapter, 1/2" W x 3/8" D (46-55 Mil), Black Rubber	6
47512-B56	SpeedSqueegee HD™, 30", Tapered Adapter, (56-74 Mil), Black Rubber	6
47512-B75	SpeedSqueegee HD™, 30", Tapered Adapter, (75+ Mil), Black Rubber	6
47512-G	SpeedSqueegee HD™, 30", Tapered Adapter, Flat, Gray Rubber	6
47512-G8	SpeedSqueegee HD™, 30", Tapered Adapter, 1/8" W x 1/16" D (8-12 Mil), Gray Rubber	6
47512-G15	SpeedSqueegee HD™, 30", Tapered Adapter, 3/16" W x 3/32" D (15-20 Mil), Gray Rubber	6
47512-G20	SpeedSqueegee HD™, 30", Tapered Adapter, 1/4" W x 1/8" D (20-28 Mil), Gray Rubber	6
47512-G30	SpeedSqueegee HD™, 30", Tapered Adapter, 3/8" W x 1/4" D (30-45 Mil), Gray Rubber	6

**FIELD TESTED TO BE LIGHTER THAN THE COMPETITION
IDEAL FOR HIGH VOLUME DECK COATING,
WATERPROOFING, AND URETHANE INSTALLATIONS**

SPEEDSQUEEGEE HD™



SMW #	DESCRIPTION	PACK QTY
47512-G46	SpeedSqueegee HD™, 30", Tapered Adapter, 1/2" W x 3/8" D (46-55 Mil), Gray Rubber	6
47512-G56	SpeedSqueegee HD™, 30", Tapered Adapter, (56-74 Mil), Gray Rubber	6
47512-G75	SpeedSqueegee HD™, 30", Tapered Adapter, (75+ Mil), Gray Rubber	6
47513-B	SpeedSqueegee HD™, 36", Tapered Adapter, Flat, Black Rubber	6
47513-B8	SpeedSqueegee HD™, 36", Tapered Adapter, 1/8" W x 1/16" D (8-12 Mil), Black Rubber	6
47513-B15	SpeedSqueegee HD™, 36", Tapered Adapter, 3/16" W x 3/32" D (15-20 Mil), Black Rubber	6
47513-B20	SpeedSqueegee HD™, 36", Tapered Adapter, 1/4" W x 1/8" D (20-28 Mil), Black Rubber	6
47513-B30	SpeedSqueegee HD™, 36", Tapered Adapter, 3/8" W x 1/4" D (30-45 Mil), Black Rubber	6
47513-B46	SpeedSqueegee HD™, 36", Tapered Adapter, 1/2" W x 3/8" D (46-55 Mil), Black Rubber	6
47513-B56	SpeedSqueegee HD™, 36", Tapered Adapter, (56-74 Mil), Black Rubber	6
47513-B75	SpeedSqueegee HD™, 36", Tapered Adapter, (75+ Mil), Black Rubber	6
47513-G	SpeedSqueegee HD™, 36", Tapered Adapter, Flat, Gray Rubber	6
47513-G8	SpeedSqueegee HD™, 36", Tapered Adapter, 1/8" W x 1/16" D (8-12 Mil), Gray Rubber	6
47513-G15	SpeedSqueegee HD™, 36", Tapered Adapter, 3/16" W x 3/32" D (15-20 Mil), Gray Rubber	6
47513-G20	SpeedSqueegee HD™, 36", Tapered Adapter, 1/4" W x 1/8" D (20-28 Mil), Gray Rubber	6
47513-G30	SpeedSqueegee HD™, 36", Tapered Adapter, 3/8" W x 1/4" D (30-45 Mil), Gray Rubber	6
47513-G46	SpeedSqueegee HD™, 36", Tapered Adapter, 1/2" W x 3/8" D (46-55 Mil), Gray Rubber	6
47513-G56	SpeedSqueegee HD™, 36", Tapered Adapter, (56-74 Mil), Gray Rubber	6
47513-G75	SpeedSqueegee HD™, 36", Tapered Adapter, (75+ Mil), Gray Rubber	6

**IDEAL FOR HIGH VOLUME DECK COATING,
 WATERPROOFING, AND URETHANE INSTALLATIONS
 FIELD TESTED TO BE LIGHTER THAN THE COMPETITION**

NOMINAL WET FILM THICKNESS CHART

Description	Notch Width	Notch Depth	WFT (in Mils*)
1/8" V-Notch	1/8"	1/16"	8 - 12
3/16" V-Notch	3/16"	3/32"	15 - 20
1/4" V-Notch	1/4"	1/8"	20 - 28
3/8" V-Notch	3/8"	1/4"	30 - 45
1/2" V-Notch	1/2"	3/8"	46-55
56-74 Mils V-Notch	~	~	56-74
75+ Mils V-Notch	~	~	75+

What squeegee notch width / notch depth should I use to apply 10 mils of epoxy? At Midwest Rake®, the answer is **always** refer to our "Nominal Wet Film Thickness Chart" to determine the appropriate notch width / notch depth required for your job. Our squeegee blades have a unique design - shallower depth notches enable Midwest Rake® squeegees to stand out from the competition ensuring a consistent and tight range of wet film thickness delivery.

This chart conversions are not absolutes and are provided to help guide blade selection. Many factors can contribute to the actual wet film thickness produced; including: pressure exerted on the blade, porosity of the substrate (concrete) being coated, material being used and if and how the back-roll is completed. If you have any questions or would like to discuss the particulars of your project - please contact us at 844-SEYMOUR and we would be more than happy to provide guidance in the application squeegee selection process.

Our general purpose squeegees are ideal for pushing or pulling liquids off from hard surfaces. Each is sold as a complete tool – handle, frame and blade. Our straight-edge squeegee has a stiffer blade for a more robust scraping action. Replacement blades are always available for all of these items. Our rollers have stainless steel axles that roll water off floors, pavement, tennis courts, golf greens and sports fields. The heavy-duty aluminum frame construction and stainless steel axles ensure the roller stays secure.



**PVA
ABSORBENT
ROLLERS**
Are great for
hard surfaces
like concrete
and asphalt.

SA10047 - 24" Non-Absorbent Replacement Roller with End Caps
SA10051 - 36" PVA (Blue) Absorbent Replacement Roller with End Caps

#	SMW #	SERIES	WARRANTY	DESCRIPTION	HEAD STYLE	HEAD-TO-HANDLE	HANDLE TYPE	GRIP	UPC	PACK QTY	PACK WEIGHT
1	76502	S600 Power™	Limited Lifetime	Squeegee	24" General Purpose	Wrap-Around Bracing	66" Premium Fiberglass	ProGrip™	046385765028	2	8.4
1	76503	S600 Power™	Limited Lifetime	Squeegee	36" General Purpose	Wrap-Around Bracing	66" Premium Fiberglass	ProGrip™	046385765035	2	9.6
2	76924	S550 Professional	Limited Lifetime	Squeegee	24" General Purpose	Wrap-Around Bracing	66" Blue Powder-Coated Aluminum	Cushion	046385769248	12	52.8
2	76936	S550 Professional	Limited Lifetime	Squeegee	36" General Purpose	Wrap-Around Bracing	66" Blue Powder-Coated Aluminum	Cushion	046385769361	12	62.4
2	76948	S550 Professional	Limited Lifetime	Squeegee	48" General Purpose	Wrap-Around Bracing	66" Blue Powder-Coated Aluminum	Cushion	046385769484	1	6.6
2	76960	S550 Professional	Limited Lifetime	Squeegee	60" General Purpose	Wrap-Around Bracing	66" Blue Powder-Coated Aluminum	Cushion	046385769606	1	8
2	76972	S550 Professional	Limited Lifetime	Squeegee	72" General Purpose	Wrap-Around Bracing	66" Blue Powder-Coated Aluminum	Cushion	046385769729	1	9
3	75036	S550 Professional™	Limited Lifetime	Squeegee	36" Double-Edge Neoprene	Wrap-Around Bracing	66" Yellow Powder-Coated Aluminum	Cushion	046385750369	1	4.8
3	75936	S550 Professional™	Limited Lifetime	Squeegee	36" Double-Edge Neoprene	Wrap-Around Bracing	66" Blue Powder-Coated Aluminum	Cushion	046385759362	1	4.8
4	70924	S550 Professional™	Limited Lifetime	Roller Squeegee	24" Non-Absorbent	Wrap-Around Bracing	60" Ergonomic Powder-Coated Aluminum	Cushion	046385709244	1	4.6
5	70936	S550 Professional™	Limited Lifetime	Roller Squeegee	36" Non-Absorbent	Wrap-Around Bracing	60" Ergonomic Powder-Coated Aluminum	Cushion	046385709367	1	5.6
6	70948	S550 Professional™	Limited Lifetime	Roller Squeegee	48" Non-Absorbent	Wrap-Around Bracing	60" Ergonomic Powder-Coated Aluminum	Cushion	046385709480	1	6.6
7	72036	S550 Professional™	Limited Lifetime	Roller Squeegee	36" PVA Absorbent	Wrap-Around Bracing	60" Ergonomic Powder-Coated Aluminum	Cushion	046385720362	1	6.4

SQUEEGEES - ASPHALT & SEAL COATING

Our clamp-style seal coating frame is equipped with wing nuts and lock washers to prevent loosening and to make blade installation and replacement very convenient. The squeegees below are sold as "complete" tools: frame, blade, bracing and handle.

**Bolted-Through
Wrap-Around Bracing**



Round Edge
Non-Tapered



Round Edge
Tapered *



Square Edge

1

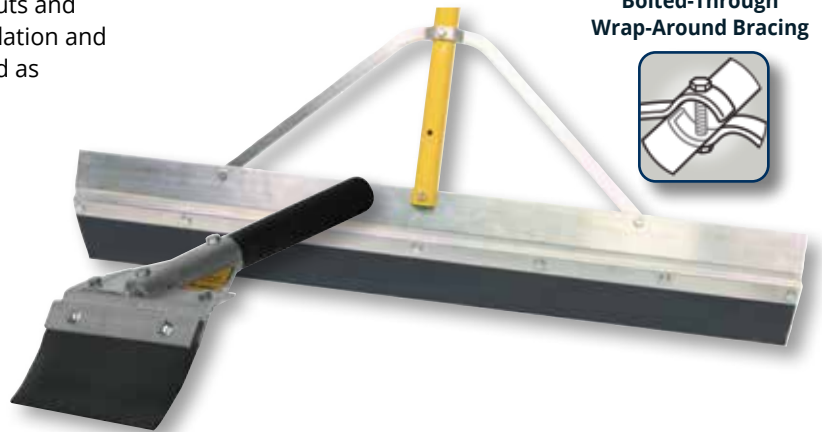

#	SMW #	SERIES	WARRANTY	DESCRIPTION	HEAD STYLE	HEAD-TO-HANDLE	GRIP	UPC	PACK QTY	PACK WEIGHT
1	78708	S550 Professional™	Lifetime	Hand-Held Squeegee	3" Tapered Rubber	Gusset Bracing	Cushion	046385787082	1	1.2
1	78709	S550 Professional™	Lifetime	Hand-Held Squeegee	2" Square Rubber	Gusset Bracing	Cushion	046385787099	1	1.2

*OS = 1-3/8" Oversized Diameter (Standard diameter is 1-1/8")

DESCRIPTION	HANDLE LENGTH	24"	36"	48"	60"	72"
3" Round Edge Non-Tapered Seal Coat Squeegee <i>Complete Tool</i>	66"	76062	76063	76064	76065	-
	66" OS*	76092	76093	76094	76095	-
	82"	76072	76073	76074	76075	-
	82" OS*	76082	76083	76084	76085	-
	Blade Only	SP50071	SP50072	SP50073	SP50074	-
3" Round Edge Tapered Seal Coat Squeegee <i>Complete Tool</i> *Favored when coating Sports Surfaces	66"	76124	76136	76148	76160	-
	66" OS*	76162	76163	76164	76165	76166
	82"	76172	76173	76174	76175	-
	82" OS*	76182	76183	76184	76185	76186
	Blade Only	SP50054	SP50055	SP50056	SP50057	SP50058
3" Square Edge Seal Coat Squeegee <i>Complete Tool</i>	66"	76024	76036	76048	76060	-
	66" OS*	76324	76336	76348	76360	-
	82"	76224	76236	76248	76260	-
	82" OS*	76424	76436	76448	76460	76472
	Blade Only	SP50034	SP50035	SP50036	SP50037	SP50038



2



3



4



5

NEW PRODUCT - 46008

46020 Red Silicone Replacement Blade for 46008 - High Heat, 70 Durometer
46021 Black Neoprene Replacement Blade for 46008 - for Cold Materials

#	SMW #	SERIES	WARRANTY	DESCRIPTION	HEAD STYLE	HEAD-TO-HANDLE	HANDLE TYPE	UPC	PACK QTY	PACK WEIGHT
2	46001	S550 Professional™	Limited Lifetime	U-Crack Squeegee	9.5" Deep 3" U-Shaped Cavity	2.25" Neoprene	Uses Tapered Wood Handle	046385460015	12	26.4
2	SP50120	S550 Professional™	-	Replacement Blade for 46001	-	-	-	046385012191	1	0.7
3	46002	S550 Professional™	Limited Lifetime	U-Crack Squeegee	2.5" Inside Cavity	1.25" Neoprene	Uses Tapered Wood Handle	046385460022	25	19.2
3	SP50121	S550 Professional™	-	Replacement Blade for 46002	-	-	-	046385012429	1	0.2
4	46005	S550 Professional™	Limited Lifetime	V-Crack Squeegee	70° Shape	2" Neoprene	Uses Tapered Wood Handle	046385460053	10	14.4
4	SP50122	S550 Professional™	-	Replacement Blade for 46005	-	-	-	046385010845	1	0.4
5	46008	S550 Professional™	-	Reversible Crack Squeegee	Reversible V-shaped head for push or pull action	Steel Construction	54" hardwood handle	046385460084	4	14.6

ASPHALT & SEAL COATING - SQUEEGEES



#	SMW #	SERIES	WARRANTY	DESCRIPTION	HEAD STYLE	HEAD-TO-HANDLE	HANDLE TYPE	GRIP	UPC	PACK QTY	PACK WEIGHT
1	76801	S550 Professional™	Limited Lifetime	Seal Coat II Squeegee	24" Rubber Blade	Wrap-Around Bracing	66" Powder-Coated Aluminum	Cushion	046385768012	1	5.2
1	76802	S550 Professional™	Limited Lifetime	Seal Coat II Squeegee	30" Rubber Blade	Wrap-Around Bracing	66" Powder-Coated Aluminum	Cushion	046385768029	1	5.7
1	76803	S550 Professional™	Limited Lifetime	Seal Coat II Squeegee	36" Rubber Blade	Wrap-Around Bracing	66" Powder-Coated Aluminum	Cushion	046385768036	1	6.4
1	76804	S550 Professional™	Limited Lifetime	Seal Coat II Squeegee	48" Rubber Blade	Wrap-Around Bracing	66" Powder-Coated Aluminum	Cushion	046385768043	1	7.6
1	76805	S550 Professional™	Limited Lifetime	Seal Coat II Squeegee	60" Rubber Blade	Wrap-Around Bracing	66" Powder-Coated Aluminum	Cushion	046385768050	1	8.8
1	76806	S550 Professional™	Limited Lifetime	Seal Coat II Squeegee	72" Rubber Blade	Wrap-Around Bracing	66" Powder-Coated Aluminum	Cushion	046385768067	1	10.3
1	76811	S550 Professional™	Limited Lifetime	Seal Coat II Squeegee	24" Rubber Blade	Wrap-Around Bracing	82" Powder-Coated Aluminum	Cushion	046385768111	1	5.6
1	76812	S550 Professional™	Limited Lifetime	Seal Coat II Squeegee	30" Rubber Blade	Wrap-Around Bracing	82" Powder-Coated Aluminum	Cushion	046385768128	1	6.2
1	76813	S550 Professional™	Limited Lifetime	Seal Coat II Squeegee	36" Rubber Blade	Wrap-Around Bracing	82" Powder-Coated Aluminum	Cushion	046385768135	1	6.7
1	76814	S550 Professional™	Limited Lifetime	Seal Coat II Squeegee	48" Rubber Blade	Wrap-Around Bracing	82" Powder-Coated Aluminum	Cushion	046385768142	1	8.2
1	76815	S550 Professional™	Limited Lifetime	Seal Coat II Squeegee	60" Rubber Blade	Wrap-Around Bracing	82" Powder-Coated Aluminum	Cushion	046385768159	1	9.2
1	76816	S550 Professional™	Limited Lifetime	Seal Coat II Squeegee	72" Rubber Blade	Wrap-Around Bracing	82" Powder-Coated Aluminum	Cushion	046385768166	1	10.4
2	76821	S550 Professional™	Limited Lifetime	Seal Coat II Squeegee	24" Rubber Blade	Wrap-Around Bracing	66" Powder-Coated Aluminum - Oversized 1.375" Diameter	Cushion	046385768210	1	5.6
2	76822	S550 Professional™	Limited Lifetime	Seal Coat II Squeegee	30" Rubber Blade	Wrap-Around Bracing	66" Powder-Coated Aluminum - Oversized 1.375" Diameter	Cushion	046385768227	1	6.1
2	76823	S550 Professional™	Limited Lifetime	Seal Coat II Squeegee	36" Rubber Blade	Wrap-Around Bracing	66" Powder-Coated Aluminum - Oversized 1.375" Diameter	Cushion	046385768234	1	6.8
2	76824	S550 Professional™	Limited Lifetime	Seal Coat II Squeegee	48" Rubber Blade	Wrap-Around Bracing	66" Powder-Coated Aluminum - Oversized 1.375" Diameter	Cushion	046385768241	1	8
2	76825	S550 Professional™	Limited Lifetime	Seal Coat II Squeegee	60" Rubber Blade	Wrap-Around Bracing	66" Powder-Coated Aluminum - Oversized 1.375" Diameter	Cushion	046385768258	1	9.2
2	76826	S550 Professional™	Limited Lifetime	Seal Coat II Squeegee	72" Rubber Blade	Wrap-Around Bracing	66" Powder-Coated Aluminum - Oversized 1.375" Diameter	Cushion	046385768265	1	10.7
2	76831	S550 Professional™	Limited Lifetime	Seal Coat II Squeegee	24" Rubber Blade	Wrap-Around Bracing	82" Powder-Coated Aluminum - Oversized 1.375" Diameter	Cushion	046385768319	1	6
2	76832	S550 Professional™	Limited Lifetime	Seal Coat II Squeegee	30" Rubber Blade	Wrap-Around Bracing	82" Powder-Coated Aluminum - Oversized 1.375" Diameter	Cushion	046385768326	1	6.6
2	76833	S550 Professional™	Limited Lifetime	Seal Coat II Squeegee	36" Rubber Blade	Wrap-Around Bracing	82" Powder-Coated Aluminum - Oversized 1.375" Diameter	Cushion	046385768333	1	7.1
2	76834	S550 Professional™	Limited Lifetime	Seal Coat II Squeegee	48" Rubber Blade	Wrap-Around Bracing	82" Powder-Coated Aluminum - Oversized 1.375" Diameter	Cushion	046385768340	1	8.6
2	76835	S550 Professional™	Limited Lifetime	Seal Coat II Squeegee	60" Rubber Blade	Wrap-Around Bracing	82" Powder-Coated Aluminum - Oversized 1.375" Diameter	Cushion	046385768357	1	9.6
2	76836	S550 Professional™	Limited Lifetime	Seal Coat II Squeegee	72" Rubber Blade	Wrap-Around Bracing	82" Powder-Coated Aluminum - Oversized 1.375" Diameter	Cushion	046385768364	1	10.8
3	SP50241	S550 Professional™	-	24" Seal Coat II Blade	Black Rubber	-	-	-	-	1	1.0
3	SP50242	S550 Professional™	-	30" Seal Coat II Blade	Black Rubber	-	-	-	-	1	1.3
3	SP50243	S550 Professional™	-	36" Seal Coat II Blade	Black Rubber	-	-	-	-	1	1.5
3	SP50244	S550 Professional™	-	48" Seal Coat II Blade	Black Rubber	-	-	-	-	1	2.0
3	SP50245	S550 Professional™	-	60" Seal Coat II Blade	Black Rubber	-	-	-	-	1	2.5
3	SP50246	S550 Professional™	-	72" Seal Coat II Blade	Black Rubber	-	-	-	-	1	3.0

ASPHALT & SEAL COATING

We offer an industry-leading assortment of asphalt seal coating tools for paving contractors, asphalt maintenance experts and municipal maintenance departments. We are a single source for the professional tools seal-coating experts prefer.



STRONG STEEL HEAD CLEANS OUT CRACKS IN ASPHALT
 • 2" x 4" head comes to a point

NEW PRODUCT - 42463

#	SMW # LEGACY #	SERIES	WARRANTY	DESCRIPTION	HEAD STYLE	HEAD-TO- HANDLE	HANDLE TYPE	GRIP	UPC	PACK QTY	PACK WEIGHT
1	42463	S550 Professional™	Limited Lifetime	V-Shaped Asphalt Crack Hoe	2" x 4" Head Comes to a Point	Steel ferrule attaches handle	60" Hardwood	-	046385424635	4	5.6
2	63128 AR-30	S550 Forged™	Limited Lifetime	Asphalt Rake	16" / 14 Tine Forged	Two Solid Steel Rivets	60" Precision Lathe Turned American Hardwood	-	046385631286	3	16.8
3	47002	S550 Professional™	Limited Lifetime	Edging Broom	7" - Head Only	Threaded Socket	-	-	046385470021	12	12
4	47245	S550 Professional™	Limited Lifetime	Sealing Broom	24" - Head Only	Threaded Socket	-	-	046385472452	6	8.4
5	47246	S550 Professional™	Limited Lifetime	Sealing Broom	36" - Head Only	Threaded Socket	-	-	046385472469	12	26.4
5	46102	S550 Professional™	Limited Lifetime	Asphalt Shoes	Felt-Soled	Heavy Riveted	-	-	046385461029	12	1.7

Move and smooth material quickly and efficiently with exactly the right lute for the task. We can customize the tool you need. Start by choosing from 5 different head styles in 4 different widths. Then choose your preferred handle diameter, bracing and length. The chart shows dozens of high performing options.



GOLIATH BRACING IS THE BEST!

Dual and convertible gusset and wrap-around bracing system with bolted-through "bracing to handle" and "handle to head" connection points.



GOLIATH BRACING



WRAP-AROUND BRACING

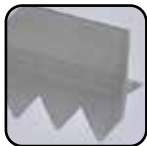

LIGHT



STANDARD



SUPER

SA60021 - Lute Bolt Bag for Wrap-Around Bracing

See page 171 for a listing of all the lute replacement heads

#	SMW #	SERIES	WARRANTY	DESCRIPTION	HEAD STYLE	HEAD-TO-HANDLE	HANDLE TYPE	GRIP	UPC	PACK QTY	PACK WEIGHT
1	56824	S600 Power™	Limited Lifetime	Light Lute	24" Heavy-Duty Aluminum	Goliath Bracing	82" Premium Fiberglass	ProGrip™	046385568247	12	55.2
1	56830	S600 Power™	Limited Lifetime	Light Lute	30" Heavy-Duty Aluminum	Goliath Bracing	82" Premium Fiberglass	ProGrip™	046385568308	12	57.6
1	56836	S600 Power™	Limited Lifetime	Light Lute	36" Heavy-Duty Aluminum	Goliath Bracing	82" Premium Fiberglass	ProGrip™	046385568360	12	60
1	56842	S600 Power™	Limited Lifetime	Light Lute	42" Heavy-Duty Aluminum	Goliath Bracing	82" Premium Fiberglass	ProGrip™	046385568421	12	62.4
2	50824	S600 Power™	Limited Lifetime	Standard Lute	24" Heavy-Duty Aluminum	Goliath Bracing	82" Premium Fiberglass	ProGrip™	046385508243	12	4.8
2	50830	S600 Power™	Limited Lifetime	Standard Lute	30" Heavy-Duty Aluminum	Goliath Bracing	82" Premium Fiberglass	ProGrip™	046385508304	12	5
2	50836	S600 Power™	Limited Lifetime	Standard Lute	36" Heavy-Duty Aluminum	Goliath Bracing	82" Premium Fiberglass	ProGrip™	046385508366	12	64.8
2	50842	S600 Power™	Limited Lifetime	Standard Lute	42" Heavy-Duty Aluminum	Goliath Bracing	82" Premium Fiberglass	ProGrip™	046385508427	12	5.2
3	56730	S550 Irrigation™	Limited Lifetime	Super Lute - 6 Pack	30" Heavy-Duty Aluminum	Wrap-Around Bracing	82" Oversized Powder-Coated Aluminum	Cushion	046385567301	6	25.2
3	56630	S550 Irrigation™	Limited Lifetime	Super Lute	30" Heavy-Duty Aluminum	Wrap-Around Bracing	82" Oversized Powder-Coated Aluminum	Cushion	046385566304	1	4.2
3	56735	S550 Irrigation™	Limited Lifetime	Super Lute - 6 Pack	36" Heavy-Duty Aluminum	Wrap-Around Bracing	82" Oversized Powder-Coated Aluminum	Cushion	046385567356	6	27.6
3	56635	S550 Irrigation™	Limited Lifetime	Super Lute	36" Heavy-Duty Aluminum	Wrap-Around Bracing	82" Oversized Powder-Coated Aluminum	Cushion	046385566359	1	4.6
3	56742	S550 Irrigation™	Limited Lifetime	Super Lute - 6 Pack	42" Heavy-Duty Aluminum	Wrap-Around Bracing	82" Oversized Powder-Coated Aluminum	Cushion	046385567424	6	45.6
3	56642	S550 Irrigation™	Limited Lifetime	Super Lute	42" Heavy-Duty Aluminum	Wrap-Around Bracing	82" Oversized Powder-Coated Aluminum	Cushion	046385566427	1	5

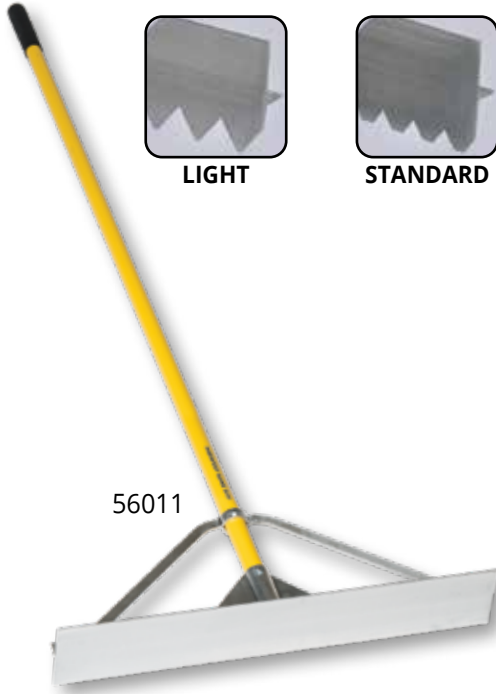

LIGHT



STANDARD



SCARIFIER



STRAIGHT
STANDARD



STRAIGHT
LIGHT



GUSSET
BRACING



WRAP-AROUND
BRACING



GOLIATH
BRACING

GOLIATH BRACING IS THE BEST!
Dual and convertible gusset and wrap-around bracing system with bolted-through "bracing to handle" and "handle to head" connection points.

See page 171 for a listing of all the lute replacement heads

HEAD STYLE	HANDLE DIAMETER	HANDLE LENGTH	BRACE STYLE	HEAD WIDTH 24"	HEAD WIDTH 30"	HEAD WIDTH 36"	HEAD WIDTH 42"		
Light Lute	1-1/8"	66"	Goliath	56001	56002	56138	56003		
			Wrap-Around	56024	56030	56036	56042		
		82"	Gusset	56025	56031	56037	56043		
			Goliath	56004	56130	56137	56005		
	Oversized 1-3/8"	82"	Wrap-Around	56224	56230	56236	56242		
			Gusset	56225	56231	56237	56243		
			Goliath	56006	56131	56437	56007		
		106"	Wrap-Around	56324	56330	56336	56342		
			Gusset	56325	56331	56337	56343		
			Goliath	56008	56009	56335	56010		
Straight Light Lute	1-1/8"	66"	Goliath	56011	56012	56141	56013		
			Wrap-Around	56027	56033	56039	56045		
		82"	Gusset	56026	56032	56038	56044		
			Goliath	56014	56133	56140	56015		
	Oversized 1-3/8"	82"	Wrap-Around	56227	56233	56239	56245		
			Gusset	56226	56232	56238	56244		
			Wrap-Around	56327	56333	56339	56345		
		106"	Gusset	56326	56332	56338	56344		
			82"	Wrap-Around	50024	50030	50036	50042	
				Gusset	50025	50031	50037	50043	
Goliath	-	-		50136	-				
Standard Lute	1-1/8"	82"	Wrap-Around	50224	50230	50236	50242		
			Gusset	50225	50231	50237	50243		
			Wrap-Around	50324	50330	50336	50342		
	Oversized 1-3/8"	106"	Gusset	50325	50331	50337	50343		
			1-1/8"	82"	Wrap-Around	50026	50033	50039	50044
					Wrap-Around	52024	52030	52036	-
Scarifier Lute	1-1/8"	82"	Wrap-Around	-	-	52037	-		
		Oversized 1-3/8"	82"	Wrap-Around	-	52032	52038	52044	

CONCRETE PLACERS - CONCRETE TOOLS

Our concrete placers are durable but also lightweight to minimize operator fatigue. Choose from aluminum, hardwood or fiberglass handles. The heads can set at varying angles to match the application and are replaceable to renew the tool for additional use.



SA60058 - Concrete Placer Replacement Hooks

#	SMW # LEGACY #	SERIES	WARRANTY	DESCRIPTION	HEAD STYLE	HEAD-TO-HANDLE	HANDLE TYPE	GRIP	UPC	PACK QTY	PACK WEIGHT
1	73310 STR-CC20	S600 Power™	Limited Lifetime	Concrete Placer with Hook	20" Steel Head	Double Bolt	60" Premium Fiberglass	ProGrip™	036723112003	2	8.4
2	73020 STR-CC20A	S600 Power™	Limited Lifetime	Concrete Placer	20" x 4" Aluminum Head	Double Bolt	60" Premium Fiberglass	ProGrip™	036723122002	1	2.8
2	73000	S550 Professional™	-	Replacement Head	20" Aluminum Head	-	-	-	046385730002	1	0.6
2	73001	S550 Professional™	-	Replacement Head with Hooks	20" Aluminum Head	-	-	-	046385730019	1	1.3
2	73021	S550 Professional™	Limited Lifetime	Concrete Placer with Hook	20" x 4" Aluminum	Double Bolt	60" Industrial Grade Fiberglass	Cushion	046385730217	1	3.5
3	73121	S550 Professional™	Limited Lifetime	Concrete Placer with Hook	20" x 4" Aluminum	Double Bolt	60" Powder-Coated Aluminum	Cushion	046385731214	12	31.2
3	73122	S550 Professional™	Limited Lifetime	Concrete Placer	20" x 4" Aluminum	Double Bolt	60" Powder-Coated Aluminum	Cushion	046385731221	12	28.8
4	73120	S550 Professional™	Limited Lifetime	Concrete Placer	20" x 4" Aluminum	Double Bolt	66" Powder-Coated Aluminum	Cushion	046385731207	12	28.8
5	73123	S550 Professional™	Limited Lifetime	Concrete Placer with Hook	20" x 4" Aluminum	Double Bolt	82" Powder-Coated Aluminum	Cushion	046385731238	1	3.8
6	73131	S550 Professional™	Limited Lifetime	Concrete Placer with Hook	20" x 4" Aluminum	Double Bolt	60" Powder-Coated Aluminum - Oversized 1.375" Diameter	Cushion	046385731313	12	31.2
6	73132	S550 Professional™	Limited Lifetime	Concrete Placer	20" x 4" Aluminum	Double Bolt	60" Powder-Coated Aluminum - Oversized 1.375" Diameter	Cushion	046385731320	12	38.4
7	73140	S550 Professional™	Limited Lifetime	Concrete Placer	20" x 4" Aluminum	Double Bolt	60" Precision Lathe Turned American Hardwood	-	046385731405	12	43.2
7	73141	S550 Professional™	Limited Lifetime	Concrete Placer with Hook	20" x 4" Aluminum	Double Bolt	60" Precision Lathe Turned American Hardwood	-	046385731412	1	3.6
8	73300 CM-30	S500 Industrial™	Limited Lifetime	Concrete Placer with Hook	20" x 4" Steel	Double Bolt	60" Precision Lathe Turned American Hardwood	-	031365129006	2	8.8

CONCRETE TOOLS - MORTAR HOES & TROWELS

OUR MORTAR HOES are ideal for mixing mortar, concrete, plaster and spackling. This tool features a forged, shank pattern. Perforated steel head and hardwood handle for strength and durability.

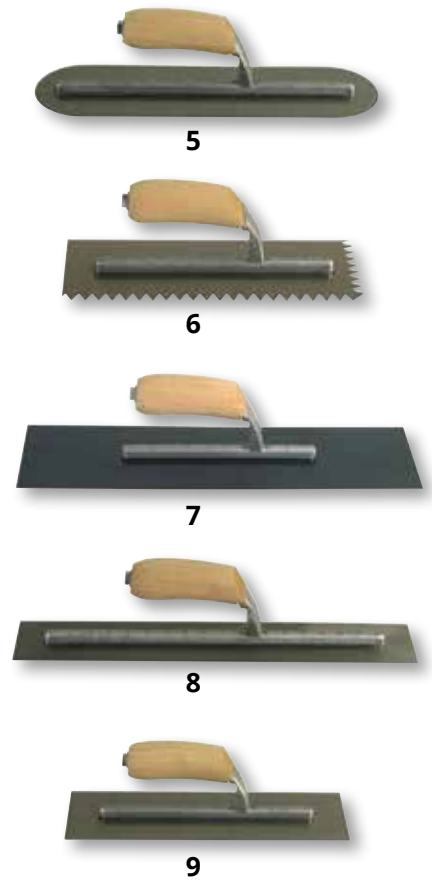
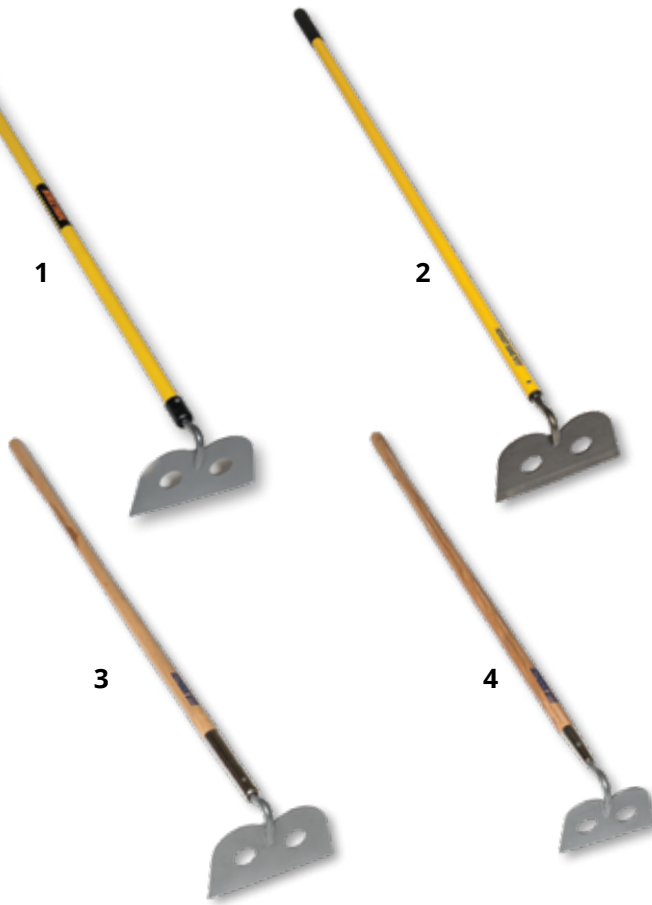

#	SMW # LEGACY #	SERIES	WARRANTY	DESCRIPTION	HEAD STYLE	HEAD-TO-HANDLE	HANDLE TYPE	GRIP	UPC	PACK QTY	PACK WEIGHT
1	42437	S800 SuperDuty™	Limited Lifetime	Mortar Hoe	Forged 10"	Nylon Collar Solid Steel Rivet	66" Premium Fiberglass	ProGrip™	036723008108	4	16
2	42430	S550 Professional™	Limited Lifetime	Mortar Hoe	10" Steel Head	Steel Plug with Solid Steel Rivet	66" Powder-Coated Aluminum	Cushion	046385424307	3	12
3	42434 MH-30	S500 Industrial™	Limited Lifetime	Mortar Hoe	10" Steel Head	Steel Ferrule	66" Precision Lathe Turned American Hardwood	-	031365129013	6	28.8
4	42432 MH-20	S500 Industrial™	Limited Lifetime	Mortar Hoe	7" Steel Head	Steel Ferrule	54" Precision Lathe Turned American Hardwood	-	031365129020	3	12.3
5	47465	S550 Professional™	Limited Lifetime	Round End Trowel	Flat Edge with Rounded Corners	Riveted	4" x 16" Overall Size	Ergonomic Wood Grip	046385474654	1	0.8
5	47475	S550 Professional™	Limited Lifetime	Round End Trowel	Flat Edge with Rounded Corners	Riveted	3" x 12" Overall Size	Ergonomic Wood Grip	046385474753	1	0.6
5	47477	S550 Professional™	Limited Lifetime	Round End Trowel	Flat Edge with Rounded Corners	Riveted	3" x 16" Overall Size	Ergonomic Wood Grip	046385474777	1	0.8
5	47466	S550 Professional™	Limited Lifetime	Round End Trowel	Flat Edge with Rounded Corners	Riveted	4" x 18" Overall Size	Ergonomic Wood Grip	046385474661	1	1
6	47402	S550 Professional™	Limited Lifetime	V-Notch Trowel	1/2" Notch Depth	Riveted	11" x 4-1/2" Overall Size	Ergonomic Wood Grip	046385474029	1	0.6
6	47403	S550 Professional™	Limited Lifetime	V-Notch Trowel	1/4" Notch Depth	Riveted	11" x 4-1/2" Overall Size	Ergonomic Wood Grip	046385474036	1	0.6
6	47406	S550 Professional™	Limited Lifetime	V-Notch Trowel	3/16" Notch Depth	Riveted	11" x 4-1/2" Overall Size	Ergonomic Wood Grip	046385474067	1	0.6
7	47468	S550 Professional™	Limited Lifetime	Flex Trowel	Rounded Edge	Riveted	5" x 16" Overall Size	Ergonomic Wood Grip	046385474685	1	0.8
7	47470	S550 Professional™	Limited Lifetime	Flex Trowel	Flat Edge	Riveted	5" x 16" Overall Size	Ergonomic Wood Grip	046385474708	1	1
8	47460	S550 Professional™	Limited Lifetime	Epoxy Mortar Trowel	Flat Edge	Riveted	3" x 12" Overall Size	Ergonomic Wood Grip	046385474609	1	0.6
8	47461	S550 Professional™	Limited Lifetime	Epoxy Mortar Trowel	Flat Edge	Riveted	3" x 16" Overall Size	Ergonomic Wood Grip	046385474616	1	0.8
9	47404	S550 Professional™	Limited Lifetime	Finishing Trowel	Flat Edge	Riveted	4" x 12" Overall Size	Ergonomic Wood Grip	046385474043	1	0.6
9	47405	S550 Professional™	Limited Lifetime	Finishing Trowel	Flat Edge	Riveted	4" x 16" Overall Size	Ergonomic Wood Grip	046385474050	1	1

For decades farmers, ranchers and fencing professionals have counted on Seymour for high quality fencing tools. Our all-steel post drivers can install posts in the toughest soil conditions. Handy fencing pliers are often used with our ring fasteners for wire and mesh fencing.

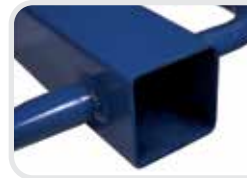

POST DRIVER CONSTRUCTION

- All steel
- Square tubing
- Powder coated
- Heavy-duty



1



2



3



4

#	SMW # LEGACY #	SERIES	WARRANTY	DESCRIPTION	DIMENSIONAL DESCRIPTION	WEIGHT	GRIP	UPC	PACK QTY	PACK WEIGHT
1	41026 2T-1900	S500 Industrial™	Limited Lifetime	Fence Pliers	10.5" Alloy Steel Head	-	Vinyl	031365107004	6	7.8
2	41020 2T-110	S500 Industrial™	Limited Lifetime	Fence Pliers	10" Square Nose Head	-	Vinyl	031365107011	6	3.5
3	41021 2T-120	S500 Industrial™	Limited Lifetime	Fence Pliers	10" Round Nose Head	-	Vinyl	031365107028	6	6.6
4	85620	S500 Industrial™	Limited Lifetime	Post Driver	2.5" Square Tube	19 lbs of Power	-	046385856207	1	19.4
4	85623	S500 Industrial™	Limited Lifetime	Post Driver	3" Square Tube	22 lbs of Power	-	046385856238	1	26.0

RING FASTENERS

CUT STYLES OF RING TIPS

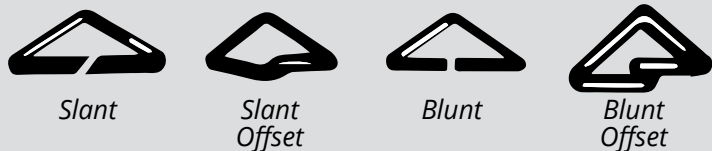

HOG RINGS are used to prevent swine from rooting in the ground. They are made from copper coated wire and come in various sizes.

Rings are defined by wire gage or diameter, material properties and cost, pattern, and cut. The ring wire materials below are listed in order of relative cost, with the least expensive listed first. For best value, select the lowest cost material that has the properties needed for the intended application.

BRIGHT BASIC STEEL RINGS are the most economical and are used for general purpose applications such as attaching tags.

COPPER COATED RINGS are economical and used for hog rings and general purpose applications.

GALVANIZED STEEL RINGS are best for applications such as fencing where moderate cost and resistance to rust are important.

ALUMINUM RINGS are relatively expensive, light weight and won't rust or corrode making them ideal for salt water use, cages and traps, and other special requirement applications.

STAINLESS STEEL RINGS are the most expensive and won't rust or corrode making them ideal for salt water use, cages and traps, food industry applications, and other special requirement applications.

HILL PATTERN RINGS close in a triangle shape.

BLAIR PATTERN RINGS close in an oval shape.

PREBENT RINGS reduce the effort needed to close the rings thus reducing hand fatigue.

ROPE TIE PATTERN RINGS are ideal for clamping rope and cable.

UPHOLSTERY PATTERN RINGS are designed to hold fabric to furniture frames.

SLANT CUT RINGS are best for applications requiring penetration such as upholstery and hog rings.

BLUNT CUT RINGS are best for applications such as fencing. They have no sharp points to cut or pierce, making them safer to handle.

NON-OFFSET RINGS close with the tips nearly touching. They are ideal for fastening large diameter materials such as fence wire where a small gap between the tips is OK.

OFFSET RING design allows the ring tips to pass for complete closure. They are best for fastening small diameter materials that could pass through a small gap.

RING FASTENERS are used for fastening wire fences, slit fences, steel mesh for wall reinforcement, fish traps, crab pots, animal cages, upholstery, and attaching tags. They are also used to clamp rubber tie-down straps and for clamping rope. Seymour rings have a variety of uses in arts and crafts such as fastening holiday wreath materials.



TAB-TOP BOXES: Packaged rings come in convenient tab-top boxes that make them ideal for effective pegboard merchandising. Each box holds from 25 to 100 rings depending on the size of the rings.



10-PACK DISPENSER BOX: Packaged ring boxes are packed in convenient dispenser cartons with 10 tab-top boxes in each dispenser carton.

BULK RINGS

Bulk rings prices are listed in the price list and special order rings are available on a quotation basis. For special needs, just provide samples or specifications.

SMW # LEGACY #	DESCRIPTION	POINT STYLE	WIRE GAGE	MATERIAL	PIECES PER CWT.
69020 RN-1H1	Hill pig rings, bulk pack	Slant	12.5	Copper plated steel	28,000
69023 RN-1H2	Hill shoat rings, bulk pack	Slant	12.5	Copper plated steel	23,600
69025 RN-1H3	Hill hog rings, bulk pack	Slant	12.5	Copper plated steel	20,600
69028 RN-1H4	Hill hog rings, bulk pack	Slant	11.0	Copper plated steel	10,800
69010 RN-1B1	Blair pig rings, bulk pack	Slant	12.5	Copper plated steel	24,000
69012 RN-1B2	Blair shoat rings, bulk pack	Slant	12.5	Copper plated steel	20,500
69015 RN-1B3	Blair hog rings, bulk pack	Slant	12.5	Copper plated steel	18,800
69030 RN-1PBH1	Hill prebent pig rings, bulk pack	Slant	12.5	Copper plated steel	26,000
69033 RN-1PBH2	Hill prebent shoat rings, bulk pack	Slant	12.5	Copper plated steel	22,600
69035 RN-1PBH3	Hill prebent hog rings, bulk pack	Slant	12.5	Copper plated steel	18,200

RING FASTENERS



RN-1H1 Hill



RR-HM / 69045



RN-1PBH1 Prebent hill



RR-HS / 69046



RR-XM / 69305



RN-1B1 Blair



RR-HLM / 69042



RR-SM / 69356



RB-31 / 69005



RB-53 / 69006



RR-HHM / 69041

Ringer pliers are specially designed to hold and close hog rings and ring fasteners.

The chart below indicates which pliers to use with the various ring patterns.

RR-SM Small

541, 542, 641, 642, 741, 742, all rings less than 3/4"

RR-HM Hill

H1, H2, H3, PBH1, PBH2, PBH3, B1, B2, B3

RR-HS Hill spring

H1, H2, H3, PBH1, PBH2, PBH3, B1, B2, B3

RR-HLM Hill wide jaw

H4, all heavy wire rings

RR-HHM Hill heavy

H4, all heavy wire rings

RR-XM Humane

X1, X3, H1, H2, H3, PBH1, PBH2, PBH3, B1, B2, B3

RR-DN De Neui

H1, H2, PBH1, PBH2, B1, B2

SMW # LEGACY #	DESCRIPTION	POINT STYLE	WIRE GAGE	MATERIAL	PIECES PER BOX.
69022 RN-H1	Hill pig rings	Slant	12.5	Copper plated steel	100
69024 RN-H2	Hill shoat rings	Slant	12.5	Copper plated steel	100
69027 RN-H3	Hill hog rings	Slant	12.5	Copper plated steel	100
69029 RN-H4	Hill hog rings	Slant	11.0	Copper plated steel	65
69011 RN-B1	Blair pig rings	Slant	12.5	Copper plated steel	100
69013 RN-B2	Blair shoat rings	Slant	12.5	Copper plated steel	100
69017 RN-B3	Blair hog rings	Slant	12.5	Copper plated steel	100
69032 RN-PBH1	Hill prebent pig rings	Slant	12.5	Copper plated steel	100
69034 RN-PBH2	Hill prebent shoat rings	Slant	12.5	Copper plated steel	100
69038 RN-PBH3	Hill prebent hog rings	Slant	12.5	Copper plated steel	100
69300 RN-X1	Humane pig rings	Slant	11.0	Copper plated steel	25
69302 RN-X3	Humane hog rings	Slant	11.0	Copper plated steel	25
69326 RN-541	Cage/trap rings	Blunt	14.0	Stainless steel	5 lbs
69327 RN-542	Cage/trap rings	Slant	14.0	Stainless steel	5 lbs
69323 RN-641	Cage/trap rings	Blunt	14.0	Galvanized steel	5 lbs
69324 RN-642	Cage/trap rings	Slant	14.0	Galvanized steel	5 lbs
69320 RN-741	Cage/trap rings	Blunt	11.0	Aluminum	2 lbs
69321 RN-742	Cage/trap rings	Slant	11.0	Aluminum	2 lbs

SMW # LEGACY #	DESCRIPTION	MATERIAL
69045 RR-HM	Hill ringer pliers	Malleable iron casting with chrome finish
69046 RR-HS	Hill spring ringer pliers	Malleable iron casting with chrome finish
69042 RR-HLM	Hill wide jaw ringer pliers	Malleable iron casting with chrome finish
69041 RR-HHM	Hill large ringer pliers	Malleable iron casting with chrome finish
69305 RR-XM	Humane ringer pliers	Malleable iron casting with chrome finish
69356 RR-SM	Small ringer pliers	Malleable iron casting with chrome finish
69005 RB-31	Bull ring, 5/16" x 2-1/2", solid brass, hinged and secured with solid brass set screw	
69006 RB-53	Bull ring 3/8" x 3", solid brass, hinged and secured with solid brass set screw	

Campfires • Charcoal Cookin' • Firepits
THE PRACTICALLY PERFECT CHARCOAL & FIREWOOD STARTER

FIRE BLOX™
FIRESTARTER



BURNS CLEAN

Seymour Midwest Fire Blox fire starters meet the strictest air quality codes in the country. Product complies with the South Coast Air Quality Management District Rule 1174.Ref.C14

CALIFORNIA PROP 65



Warning: Combustion of this product will result in the emission of carbon monoxide, soot and other combustion by-products which are known by the state of California to cause cancer & birth defects as well as reproductive harm. For more information go to www.P65Warnings.ca.gov

In California, use of this and other solid fuels may be restricted at times by law. Call 1-877-466-2876 or check www.8774noburn.org before burning.

WHY SEYMOUR FIRE BLOX FIRESTARTERS:

Starts all types of fires

- *Each piece measures 1.75" x 1.5" x .5"*
- Superior to liquids and other solid starters.
- Great for starting firewood, pellets, coal, and charcoal.
- Eliminates the need for liquids, kindling, and newspaper.

Works great even when it's wet

- Pieces burn hot for about 12 min. for fast, sure starts.
- Lights quickly, even when wet.
- Will ignite even damp firewood.

Safe to use anywhere

- Can't leak, spill, flash, flare-up, or explode.
- Safe to use both indoors and outdoors.
- Non-toxic.
- Stores safely anywhere with long shelf life.

Economical - just pennies per light

- Need only 2 or 3 pieces to start.
- A 24-pc. package provides 8-12 starts.
- Pieces are scored and separate easily.

Burns clean

- Environmentally friendly
- Meets the strictest US air quality codes.

FOR CAMPFIRES -



Use one or more Fire Blox with twigs / wood scraps under the logs. Starts in rain and moderate wind. Ignites even damp wood.

FOR CHARCOAL GRILLS -



Place 3 Fire Blox cubes on edge in charcoal, leaving air space as shown, and light frayed edges of cubes.

FOR FIREPLACES -



Place one or more Fire Blox under at least 3 logs and light; no kindling needed.

FIRESTARTER & STACK-IT BRACKET

Seymour Fire Blox™ capture instant add-on sales in a variety of store environments. Merchandise them with:

- Outdoor grills and outdoor fireplace supplies
- Patio firepits, outdoor heaters and chimineas
- Camping supplies including hunting, fishing and backpacking
- Indoor fireplaces, wood stoves and heaters



THESE CARTONS CONVERT INTO POP DISPLAYS

The 24 box/pack shipper cartons can be quickly converted to an attention-grabbing full-color shelf or counter display with a large header card

HEAVY-DUTY STACK-IT BRACKETS™

Steel fixtures used to hold two-by-fours together for storage racks, shelving, workbenches, and stands.

- Protects firewood: They have a unique design that keeps firewood high, dry, and safe from pests and decay.
- Adjustable: They can be built to any length.
- Easy to use: Simple, fast assembly and disassembly without tools, screws or bolts.

#	SMW # LEGACY #	DESCRIPTION	PIECE PER BOX	PACK QTY	PACK WEIGHT
1	98002 30-054	Fire Blox™ Firestarter	4 pc. Trial Size Cello Pack	104	15.1
2	98001 30-052	Fire Blox™ Firestarter	24 pc. Cello Pack	12	9.75
3	98000 30-050-12	Fire Blox™ Firestarter	24 pc. Trial Box	12	10.6
4	98003 30-589	Fire Blox™ Firestarter	144 pc. Bulk Pack Box	8	39.5
5	98000PP 30-050-24	Fire Blox™ Firestarter	24 pc. Box - 24 Boxes in POP Display Carton	1	21.5
6	98001PP 30-052-24	Fire Blox™ Firestarter	24 pc. Cello Pack - 24 Packs in POP Display Carton	1	18.1
7	98039 30-360	Stack-It Bracket Set	4 Steel Brackets per Set	6	26.4

COLORFUL FLOOR DISPLAYS

Can double or triple your inventory turns by attracting customer attention and using space efficiently. Great for end-caps, sidewalk displays, and seasonal merchandise. Ask for a complimentary copy of our brand new merchandising ideas guide with many standard display assortments.

STEEL MOBILE RACKS

Are easy to assemble and can be used indoors or outdoors in any weather. They attract customer attention, and display tools and use space efficiently.

USE SPACE EFFICIENTLY AND MAXIMIZE IMPACT

We custom-design planograms to maximize customer appeal and sell-through. Careful planning ensures that premium wall space yields maximum return on inventory investment.

MANY PLANOGRAM OPTIONS ARE AVAILABLE

With a variety of long handled and garden tool assortments. We develop planogram systems for retail hardware, lawn and garden, industrial supply, landscape wholesaler, irrigation wholesaler, utility wholesaler, fencing dealer / distributor, lumberyard, farm and ranch supply, and other markets.

To get started, contact our merchandising experts at Customer.Service@SeymourMidwest.com.



YDIS296
6' LARGE MULTI-TOOL



YDIS170
2' ROLLING STEEL RACK



YDIS195
3' ROLLING STEEL RACK



YDIS166
COMPACT STRIKING
TOOL RACK

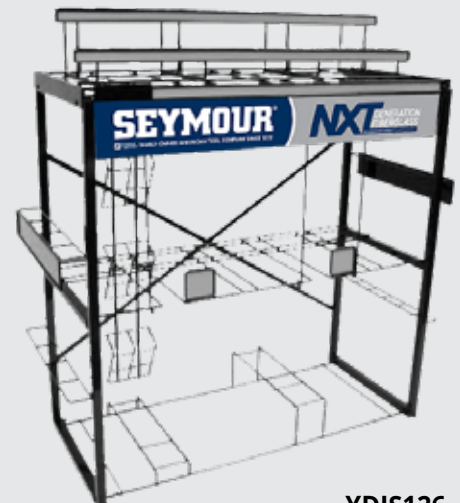

YDIS126
THREE-TIERED STRIKING
TOOL RACK

001-01	103	104-08	102	423-19	105	960-21	114	21409	120	41467	130
001-02	103	116-02	102	423-99	109	977-21	110	21420	121	41473	127
001-08	103	116-08	102	424-19	105	978-21	110	21424	121	41474	127
001-19	103	116-19	102	430-01	105	989-21	115	21426	121	41476	127
001-99	109	118-19	102	430-02	105	990-21	115	21428	121	41481	131
002-01	103	119-19	102	430-08	105	1172-02	106	21430	121	41483	129
002-02	103	124-02	102	430-19	105	04510-00	107	21438	121	41484	131
002-08	103	124-19	102	432-02	105	04511-00	107	21450	121	41485	129
002-19	103	140-02	102	432-19	105	04512-00	107	21451	121	41486	130
2B-42B20	121	140-08	102	433-02	105	04513-00	107	21452	121	41487	130
2B-42G28	121	140-19	102	433-08	105	04514-00	107	21504	144	41488	131
2B-42G30	121	140-99	109	433-19	105	6321-19	106	21505	144	41489	129
2B-42W24	121	142-19	102	435-19	105	06903-00	108	29541-00	106	41492	128
2B-42W26	121	145-02	102	440-19	105	06904-00	108	29542-00	106	41498	132
2B-040128	121	145-08	102	451-19	105	06905-00	108	29543-00	106	41499	132
2C-33	125	145-19	102	474-55	105	06906-00	108	29544-00	106	41500	84
2C-66	125	200-19	102	477-19	105	7001-00	109	29545-00	106	41501	84
2C-99	125	200-99	109	477-55	105	7078-19	106	30569-00	107	41502	84
2E-1G7	73	205-02	103	480-02	105	7248-00	113	30571-00	107	41503	84
2E-AE0	73	205-08	103	480-19	105	10024	68	30572-00	107	41593	91
2E-AE1	73	205-19	103	480-99	109	10030	68	30573-00	107	41594	91
2E-AE2	73	206-02	103	481-19	105	10036	68	30574-00	107	41595	91
2E-G60	73	206-08	103	700-21	110	10042	68	30575-00	107	41596	91
2G-25LH	123	206-19	103	701-21	110	10048	68	30576-00	107	41599	91
2G-497	123	210-19	102	706-21	110	11024	69, 147	31559-00	107	41600	146
2G-507	123	213-19	103	707-21	110	11030	69, 147	31561-00	107	41602	146
2P-CN13	125	214-19	102	708-21	110	11036	69, 147	31562-00	107	41604	146
2P-MA12	124	215-19	102	711-21	110	11042	69, 147	31563-00	107	41606	146
2P-MA18	124	220-01	103	715-21	110	11048	69, 147	31564-00	107	41608	146
2P-MA18S	124	220-02	103	716-21	110	11100	69	31565-00	107	41610	146
2P-MA22	124	220-08	103	717-21	110	11101	69	39652-21	113	41612	146
2P-MA22S	124	220-19	103	728-21	110	11102	69	39658-21	113	41614	146
2P-MA24	124	220-99	109	730-21	110	11103	69	39659-21	113	41616	146
2P-MA24S	124	221-99	109	731-21	110	11104	69	40872	63	41618	146
2T-110	161	224-02	104	734-21	110	12024	67, 147	40880	63	41700	123
2T-120	161	224-19	104	736-21	110	12030	67, 147	40882	63	41705	123
2T-1900	161	228-01	104	739-21	111	12036	67, 147	40884	63	41711	123
003-02	103	228-19	104	741-21	111	12042	67, 147	40885	63	41712	124
003-08	103	229-08	104	742-21	111	12048	67, 147	40912	60	41718	124
003-19	103	229-19	104	743-21	111	12072	67	40924	60	41719	124
004-01	103	240-08	103	744-21	111	12100	68	40928	60	41722	124
004-08	103	240-19	103	746-21	111	12101	68	40932	60	41723	124
004-19	103	255-19	104	747-21	111	12102	68	40936	60	41724	124
009-19	103	260-08	104	748-21	111	12103	68	40940	60	41725	124
010-02	103	260-19	104	750-21	114	12104	68	40942	60	41730	125
010-09	103	262-19	104	752-21	111	12501	71, 147	40945	60	41740	125
010-19	103	300-02	104	753-21	111	12502	71, 147	40948	60	41745	125
010-99	109	300-08	104	756-21	111	12503	71, 147	41020	161	41748	125
13-390	108	300-19	104	757-21	111	12517	70	41021	161	41805	82
13-391	108	300-99	109	758-21	111	12524	70, 147	41026	161	41806	82
13-392	108	302-02	104	760-21	111	12536	70, 147	41031	134	41807	82
13-393	108	304-02	104	765-21	111	14024	68	41033	134	41808	84
13-394	108	304-08	104	767-21	111	14030	68	41034	134	41809	82
13-395	108	304-19	104	789-21	114	14036	68	41035	134	41810	87
015-02	103	310-02	104	790-21	112	14042	68	41040	134	41811	82
015-19	103	312-02	104	794-21	112	14048	68	41041	134	41812	82
22-023	112	312-08	104	797-21	112	16113	70	41042	134	41814	84
22-025	113	312-19	104	807-21	115	16114	69	41044	125	41815	84
22-027	112	313-19	104	808-21	115	16117	69	41045	125	41818	85
22-033	112	321-02	104	810-21	110	20024	70	41046	125	41819	85
22-076	112	321-08	104	811-21	73, 110	20030	70	41050	145	41820	85
22-245	113	321-19	104	813-21	103	20036	70	41054	127	41821	86
22-250	113	322-19	104	823-21	114	20042	70	41055	127	41822	87
22-299	113	324-00	107	824-21	114	20048	70	41202	134	41823	85
22-300	113	325-02	104	825-21	114	20060	70	41212	134	41824	85
22-342	111	325-08	104	827-21	113	21025	57	41222	134	41825	85
22-348	111	325-19	104	828-21	113	21060	57	41250	144	41830	84
22-350	113	327-19	104	829-21	114	21075	57	41251	144	41831	84
22-351	111	330-02	106	834-21	115	21100	57	41255	144	41832	86
22-360	111	330-08	106	836-21	115	21105	57	41366	70	41833	85
22-388	116	330-19	106	838-21	115	21106	57	41395	132	41834	85
22-604	111	334-19	106	841-21	115	21108	57	41398	132	41835	85
22-849	116	350-02	106	842-21	115	21110	57	41403	127	41836	84
023-19	103	350-19	106	844-21	115	21200	56	41406	127	41837	85
30-050-12	165	365-02	106	863-21	112	21206	56	41407	127	41838	85
30-050-24	165	365-19	106	864-21	112	21208	56	41411	130	41839	85
30-052	165	368-02	106	865-21	112	21210	56	41414	130	41840	86
30-052-24	165	368-08	106	866-21	112	21211	56	41415	130	41845	86
30-054	165	368-19	106	867-21	112	21219	56	41416	131	41846	86
30-360	165	369-19	106	870-21	114	21220	58	41417	131	41847	86
30-589	165	400-19	104	870-99	109	21230	58	41418	125	41848	87
35-025	113	401-19	104	871-21	114	21244	58	41420	125	41849	87
35-026	113	403-02	104	871-99	109	21245	58	41421	128	41850	82
35-029	113	403-08	104	873-21	114	21246	58	41422	128	41851	82
36-025	113	403-19	104	876-21	114	21248	58	41423	128	41852	82
50-490	107	405-02	104	880-21	114	21264	58	41424	128	41853	84
50-491	107	405-08	104	881-21	114	21266	58	41426	126	41854	84
50-492	107	405-19	104	892-21	114	21268	58	41430	146	41855	84
50-493	107	407-02	105	896-21	115	21302	59	41432	146	41856	85
50-494	107	407-08	105	897-21	115	21303	59	41434	146	41858	85
50-497	108	407-19	105	898-21	115	21304	59	41436	146	41859	85
100-01	102	409-02	105	905-21	112	21306	59	41440	146	41860	85
100-02	102	409-08	105	922-21	110	21308	59	41444	146	41861	85
100-08	102	409-19	105	924-21	111	21310	59	41446	146	41862	85
100-19	102	421-02	105	930-21	112	21324	59	41448	146	41871	83
100-99	109	421-19	105	950-21	115	21326	59	41453	126	41872	83
102-02	102	423-01	105	951-21	115	21332	59	41461	129	41873	83
102-08	102	423-02	105	952-21	115	21401	120	41463	129	41874	83
102-19	102	423-08	105	953-21	115	21408	120	41465	130	41876	83

INDEX

41877	83	46048	139	49048	119	49368	39, 48	49758	33	56045	158
41878	83	46102	156	49050	55	49430	23	49759	20	56130	158
41879	83	46195	150	49051	55	49431	23	49760	26	56131	158
41880	88	46198	150	49053	55	49432	29	49761	45	56133	158
41882	88	46199	150	49060	53	49433	29	49772	26	56137	158
41885	88	47002	156	49061	51	49437	35	49774	38	56138	158
41886	88	47025	138	49062	51	49450	23	49776	32	56140	158
41887	88	47026	138	49063	53	49451	23	49777	32	56141	158
41888	88	47027	138	49064	52	49452	28	49782	48	56224	158
41890	88	47037	138	49066	53	49453	39	49830	24	56225	158
41892	88	47045	138	49068	52	49454	39	49831	24	56226	158
42004	74	47046	138	49069	52	49455	46	49832	29	56227	158
42016	65	47245	156	49070	77	49456	34	49833	29	56230	158
42100	73	47246	156	49076	75	49457	34	49910	54	56231	158
42103	74	47402	160	49077	75	49459	34	49920	23	56232	158
42141	73	47403	160	49078	76	49459LO	34	49921	29	56233	158
42201	74	47404	160	49079	119	49462	28	49924	65	56236	158
42204	74	47405	160	49081	123	49465	47	49957	38	56237	158
42224	74	47406	160	49085	47	49490	25	49958	38	56238	158
42244	74	47460	160	49130	24	49491	25	49961	45	56239	158
42254	74	47461	160	49131	24	49492	31	50001-00	116	56242	158
42256	77	47465	160	49132	29	49493	31	50005-00	116	56243	158
42280	132	47466	160	49134	39	49497	37	50006-00	116	56244	158
42320	65	47468	160	49137	35	49500	25	50024	158	56245	158
42324	64	47470	160	49138	34	49501	25	50025	158	56324	158
42350	66	47475	160	49142	29	49502	31	50025-00	116	56325	158
42351	66	47477	160	49150	23	49503	31	50026	158	56326	158
42355	65	47511-B	151	49151	23	49507	37	50030	158	56327	158
42357	64	47511-B8	151	49152	28	49510	55	50031	158	56330	158
42364	65	47511-B15	151	49153	39	49512	53	50033	158	56331	158
42366	64	47511-B20	151	49154	39	49538	35	50036	158	56332	158
42390	66	47511-B30	151	49155	47	49539	21	50037	158	56333	158
42410	72	47511-B46	151	49156	35	49540	25	50039	158	56335	158
42420	72	47511-B56	151	49157	35	49541	25	50042	158	56336	158
42425	72	47511-B75	151	49162	28	49542	31	50043	158	56337	158
42430	160	47511-G	151	49163	22	49543	31	50044	158	56338	158
42432	160	47511-G8	151	49164	22	49546	37	50136	158	56339	158
42434	160	47511-G15	151	49168	48	49547	37	50224	158	56342	158
42437	160	47511-G20	151	49169	48	49553	38	50225	158	56343	158
42441	72	47511-G30	151	49170	21	49554	38	50230	158	56344	158
42448	72	47511-G46	151	49171	21	49556	33	50231	158	56345	158
42450	72	47511-G56	151	49172	27	49557	33	50236	158	56437	158
42455	72	47511-G75	151	49173	27	49558	33	50237	158	56630	157
42458	72	47512-B	151	49174	39	49559	33	50242	158	56635	157
42460	73	47512-B8	151	49175	46	49560	20	50243	158	56642	157
42461	73	47512-B15	151	49178	48	49561	20	50324	158	56730	157
42463	156	47512-B20	151	49180	46	49562	26	50325	158	56735	157
42465	73	47512-B30	151	49181	45	49563	26	50330	158	56742	157
42468	73	47512-B46	151	49185	47	49566	33	50331	158	56824	157
42469	73	47512-B56	151	49190	50	49567	33	50336	158	56830	157
42485	73	47512-B75	151	49191	48	49576	32	50337	158	56836	157
42600	64	47512-G	151	49216	49	49577	32	50342	158	56842	157
42604	64	47512-G8	151	49217	49	49585	46	50343	158	56923	147
42610	73	47512-G15	151	49240	51	49588	45	50824	157	56924	147
42690	66	47512-G20	151	49241	51	49589	32	50830	157	56929	147
42800	73	47512-G30	151	49242	51	49597	36	50836	157	56930	147
42801	73	47512-G46	152	49248	49	49599	20	50842	157	56935	147
42802	73	47512-G56	152	49249	49	49630	20	51924	147	56936	147
42805	73	47512-G75	152	49251	54	49631	20	51936	147	60240	97
42808	73	47513-B	152	49253	54	49640	24	52024	158	60241	97
43108	62	47513-B8	152	49257	49	49641	24	52030	158	60242	97
43110	62	47513-B15	152	49265	52	49642	30	52032	158	60244	97
43118	62	47513-B20	152	49267	53	49643	30	52036	158	60245	97
43120	62	47513-B30	152	49268	52	49650	24	52037	158	60246	97
43308	62	47513-B46	152	49269	53	49652	30	52038	158	60247	97
43309	61	47513-B56	152	49270	53	49653	38	52044	158	60248	97
43310	61	47513-B75	152	49271	76	49654	38	52917	71, 148	60250	97
43318	62	47513-G	152	49272	76	49656	36	52936	148	60251	97
43319	61	47513-G8	152	49273	76	49657	36	56001	158	60252	97
43320	61	47513-G15	152	49274	75	49658-21	113	56002	158	60253	97
43324	62	47513-G20	152	49275	75	49659-21	113	56003	158	60254	97
43325	61	47513-G30	152	49276	75	49662	30	56004	158	60255	97
43326	61	47513-G46	152	49277	75	49666	36	56005	158	60256	97
43372	60	47513-G56	152	49278	75	49667	36	56006	158	60259	97
44111	77	47513-G75	152	49279	76	49669	36	56007	158	60270	97
44111BA	77	49006	50	49280	76	49691	45	56008	158	60271	97
45000	21	49010	54	49283	75	49692	45	56009	158	60272	97
45010	21	49010LO	54	49286	75	49770	20	56010	158	60273	97
45011	21	49013	50	49288	75	49730	20	56011	158	60274	97
45100	22	49014	50	49330	22	49731	20	56012	158	60275	97
45110	22	49015	50	49331	22	49732	26	56013	158	60276	97
45122	27	49016	50	49332	28	49733	38	56014	158	60279	97
45132	27	49017	50	49333	28	49734	38	56015	158	60700	133
45140	21	49019	49	49334	39	49735	46	56024	158	60701	133
45141	21	49028	78	49335	39	49736	32	56025	158	60703	133
45142	27	49029	78	49336	36	49737	32	56026	158	60710	133
45143	27	49030	78	49337	36	49742	26	56027	158	60711	133
45200	23	49031	79	49339	28	49744	20	56030	158	60712	133
45201	23	49032	79	49340	22	49748	47	56031	158	60720	133
45202	29	49033	79	49342	28	49749	48	56032	158	60721	133
45203	29	49034	79	49344	22	49750	20	56033	158	60723	133
45411	47	49035	78	49345	28	49751	26	56036	158	60725	133
45420	47	49039	78	49346	34	49752	33	56037	158	60727	133
46001	154	49042	119	49348	35	49753	56	56038	158	63001	73, 110
46002	154	49043	119	49351	23	49754	64	56039	158	63009	73
46005	154	49044	142	49352	23	49755	52	56042	158	63011	73
46008	154	49045	142	49353	28	49756	78	56043	158	63025	103
46032	139	49047	119	49357	35	49757	54	56044	158	63031	89

63124	66	64774	103	65583	105	66675	115	73132	159	78916	79
63126	66	64777	103	65586	105	66678	110	73140	159	79849	149
63128	66, 156	64889	102	65592	105	66681	110	73141	159	79850	149
63130	66	64890	102	65594	105	66682	73, 110	73300	159	79851	149
64021	101	64894	102	65596	105	66689	103	73310	159	79853	149
64024	101	64903	102	65598	105	66693	114	73320	70	79854	149
64026	101	64913	102	65697	105	66700	114	75036	153	79856	149
64027	101	64914	102	65701	105	66702	114	75936	153	79857	149
64084	116	64918	102	65710	105	66704	113	76024	154	79859	149
64085	116	64927	102	65711	105	66713	113	76036	154	79860	149
64098	116	64937	102	65712	105	66716	114	76048	154	79862	149
64099	116	64939	102	65714	105	66717	114	76060	154	79863	149
64112	109	64941	102	65716	105	66722	115	76062	154	79865	149
64128	107	64944	102	65725	109	66724	115	76063	154	79866	149
64131	107	64945	102	65737	105	66727	115	76064	154	79868	149
64133	107	64946	102	65741	105	66728	115	76065	154	79869	149
64136	107	65030	103	65742	105	66730	115	76072	154	79871	149
64139	107	65031	103	65743	105	66733	115	76073	154	79872	149
64140	108	65035	103	65744	105	66745	112	76074	154	82008	137
64141	108	65053	109	65746	105	66753	112	76075	154	82014	137
64142	108	65059	103	65748	105	66754	112	76082	154	82018	138
64143	108	65060	103	65749	105	66759	112	76083	154	82084	139, 148
64144	107	65117	102	65751	105	66761	112	76084	154	82104	135
64145	107	65119	103	65758	105	66763	112	76085	154	82106	135
64146	107	65121	102	65759	105	66766	114	76092	154	82118	137
64147	107	65123	102	65760	105	66770	109	76093	154	82124	136
64148	107	65130	104	65764	105	66773	114	76094	154	82136	136
64149	108	65132	104	65768	105	66776	109	76095	154	82328	139
64151	108	65136	104	65782	105	66778	114	76124	154	82384	139, 148
64153	108	65138	104	65868	105	66781	114	76136	154	82500	138
64155	108	65140	104	65898	106	66784	114	76148	154	82602	136
64157	108	65141	104	65902	106	66787	114	76160	154	82614	136
64158	108	65163	113	65905	106	66794	114	76162	154	82624	136
64159	108	65220	104	65993	105	66798	115	76163	154	82704	135
64205	116	65227	104	65994	105	66800	115	76164	154	82706	135
64207	116	65228	104	65998	109	66801	115	76165	154	82718	137
64223	106	65236	104	66004	105	66802	112	76166	154	82724	136
64224	106	65273	106	66425	112	66806	110	76172	154	82728	135
64225	106	65274	106	66426	113	66807	111	76173	154	82736	136
64227	106	65275	106	66427	112	66808	112	76174	154	82902	135
64229	106	65278	106	66428	112	66813	115	76175	154	82904	135
64231	107	65282	106	66430	112	66816	115	76182	154	82905	135
64232	107	65283	106	66439	113	66819	115	76183	154	82906	135
64234	107	65288	106	66441	113	66820	115	76184	154	82918	138
64235	107	65289	106	66446	113	66823	114	76185	154	82919	138
64236	107	65292	106	66448	113	66826	110	76186	154	82924	137
64237	107	65293	106	66454	111	66827	110	76224	154	82925	137, 148
64238	107	65295	106	66455	111	66831	115	76236	154	82926	136
64240	107	65296	106	66459	113	66833	115	76248	154	82928	135
64241	107	65297	106	66460	111	69005	163	76260	154	82936	137
64242	107	65300	106	66464	111	69006	163	76324	154	83084	139, 148
64243	107	65309	106	66491	111	69010	162	76336	154	83328	139
64244	107	65361	105	66534	113	69011	163	76348	154	83384	139, 148
64245	107	65365	105	66539	113	69012	162	76360	154	83728	135
64246	107	65367	105	66542	113	69013	163	76424	154	83928	135
64403	103	65382	104	66545	113	69015	162	76436	154	85008	91
64407	103	65383	104	66547	113	69017	163	76448	154	85010	91
64409	103	65386	104	66548	113	69020	162	76460	154	85050	91
64412	103	65388	104	66549	113	69022	163	76472	154	85054	91
64417	103	65392	104	66554	113	69023	162	76502	153	85058	91
64419	103	65399	109	66555	113	69024	163	76503	153	85060	91
64430	109	65402	104	66560	110	69025	162	76801	155	85068	91
64441	103	65403	104	66561	110	69027	163	76802	155	85078	91
64536	103	65406	104	66564	110	69028	162	76803	155	85088	91
64537	103	65407	104	66566	110	69029	163	76804	155	85090	91
64538	103	65409	104	66568	110	69030	162	76805	155	85300	92
64542	103	65412	104	66570	110	69032	163	76806	155	85301	92
64547	103	65415	104	66574	110	69033	162	76811	155	85302	92
64548	103	65416	104	66575	110	69034	163	76812	155	85303	92
64549	103	65417	104	66580	110	69035	162	76813	155	85304	92
64552	103	65419	104	66585	110	69038	163	76814	155	85305	92
64558	103	65424	104	66592	110	69041	163	76815	155	85306	92
64559	103	65426	104	66595	110	69042	163	76816	155	85307	92
64563	103	65427	104	66599	110	69045	163	76821	155	85308	92
64574	103	65428	104	66600	110	69046	163	76822	155	85310	142
64645	103	65430	104	66601	110	69300	163	76823	155	85350	92
64650	103	65435	104	66603	111	69302	163	76824	155	85351	92
64652	103	65436	104	66607	111	69305	163	76825	155	85353	92
64659	103	65437	104	66611	111	69320	163	76826	155	85356	92
64662	103	65438	104	66615	111	69321	163	76831	155	85358	93
64698	102	65440	104	66618	111	69323	163	76832	155	85360	93
64701	102	65445	104	66621	111	69324	163	76833	155	85361	93
64703	102	65447	104	66623	111	69326	163	76834	155	85364	93
64709	102	65449	104	66627	111	69327	163	76835	155	85365	93
64718	109	65530	104	66628	114	69356	163	76836	155	85366	93
64731	102	65535	104	66631	111	70924	153	76924	153	85367	93
64738	102	65539	104	66635	111	70936	153	76936	153	85368	93
64740	102	65541	104	66639	111	70948	153	76948	153	85369	93
64743	102	65546	104	66643	111	72036	153	76960	153	85422	144
64749	109	65548	104	66644	111	73000	159	76972	153	85423	144
64762	102	65559	104	66646	111	73001	159	77036	139	85424	144
64764	109	65560	104	66647	111	73020	159	77136	139	85426	144
64765	103	65562	104	66649	111	73021	159	78255	149	85427	144
64766	103	65565	104	66653	114	73120	159	78256	149	85428	144
64767	103	65569	104	66656	112	73121	159	78708	154	85430	144
64768	103	65578	105	66664	112	73122	159	78709	154	85450	143
64772	103	65579	105	66668	112	73123	159	78908	79	85452	143
64773	103	65581	105	66673	115	73131	159	78912	79	85455	143

INDEX

85462	142	89223	44	DG-AEH	73	SD-20	119	STR-S712	20	SV-SDP12L	54
85465	142	89224	44	DG-AEH-60	73	SF-10	75	STR-S713	47	SV-SDP12W	55
85466	142	89225	44	DG-PP60	93	SF-30	75	STR-S717	43	SV-SDP12WP	55
85468	142	89226	44	DG-WP60	93	SF-40	75	STR-S800	20	SV-SDS12	49
85469	142	89233	44	DR-DC4	144	SG-2DH	48	STR-S801	26	SV-SDSC2	49
85480	144	89234	44	DR-DC5	144	SG-2LH	48	STR-S805D	38	SV-SLA12	52
85481	144	89235	44	DT-1640	122	SH-20	73	STR-S819D	48	SV-SLSC2-54	49
85482	144	89236	44	EF-20D	76	SH-36	73	STR-SB24R	138	SV-SP20	140
85483	144	89243	43	FP-20	132	SH-37	73	STR-SE12	97	SV-SS10	50
85484	143	89244	43	FR-21	66	SK-70H	133	STR-SE24	97	SV-SS10L	50
85485	144	89245	43	FR-70	133	SN-1	120	STR-SE36	97	SV-SS11	50
85486	143	89246	43	GC-10	74	SN-8	120	STR-SE48	97	SV-SS20	140
85487	143	89273	43	GC-20	74	SN-9	120	STR-SE612	97	SV-TR14	40
85490	143	89274	43	GC-30	74	SP-16LB	121	STR-SE816	97	SV-TR15	40
85491	143	89275	43	GC-40	74	SP-16UB	121	STR-SE824	97	SV-TR23	44
85495	143	90324	69	GC-70	133	SP-16UG	121	STR-SG1	48	SV-TR24	44
85496	143	90330	69	GC-70H	133	SP50034	154	STR-SP48	142	SV-TR25	44
85499	143	92024	67	GH-10	72	SP50035	154	STR-SP60	142	SV-TR44	40
85520	89	92030	67	GH-20	72	SP50036	154	STR-SR22	60	SV-TR45	40
85522	89	92036	67	GH-30	72	SP50037	154	STR-SS7	97	SV-TR403	44
85525	90	92042	67	GH-40	72	SP50038	154	STR-SS48	97	SV-TR404	44
85526	90	92048	67	GH-80	72	SP50054	154	STR-SS60	97	SV-TR405	44
85529	134	92324	67	GH-90	72	SP50055	154	STR-SW7	78	TP-8FG	91
85564	89	92330	67	HF-20	76	SP50056	154	STR-TP612	132	TP-30	91
85565	89	92336	67	HM-949	134	SP50057	154	SV-CR50	45	TP-32	91
85566	89	92342	67	IC-30	78	SP50058	154	SV-DD10	35	TR-30	66
85567	89	92348	67	LF-8	63	SP50071	154	SV-DD20	35	VH-70	133
85571	89	96022	141	LF-18	60	SP50072	154	SV-DD30CB	35	WB-4S	96
85572	89	96048	141	LF-20	63	SP50073	154	SV-DD40	34	WB-6P	96
85573	89	96060	141	LF-22	60	SP50074	154	SV-DD46	34	WB-6SHD	95
85575	90	96148	141	LF-22PS	60	SP50120	154	SV-DD46XL	34	WB-6SHDS	95
85576	90	96322	141	LF-25	60	SP50121	154	SV-DD80	35	WB-10P	95
85577	90	96624	141	LF-30P	63	SP50122	154	SV-DR12	24	WB-JR	95
85578	90	96636	141	LF-30PCG	63	SP50162	143	SV-DR22	23	WB-JRB	95
85580	89	96640	78	LF-40	60	SP50163	143	SV-DR32	22	WB-JRD	95
85582	89	96701	141	LR-36A	67	SP50164	143	SV-DR42	23	WE-20	122
85585	90	96806	141	MC-5H	89	SP50167	143	SV-DR52	21	WE-30	122
85586	90	96809	140	MF-24	75	SP50241	155	SV-DR72	133	WE-35	122
85590	134	96811	79	MF-24L	75	SP50242	155	SV-DR82	23	WE-40	122
85591	134	96817	141	MF-25	75	SP50243	155	SV-DR92	24	WE-51	119
85592	134	96818	140	MF-25L	75	SP50244	155	SV-DRCH	48	WE-52	119
85620	161	96827	140	MF-26	75	SP50245	155	SV-DRMP	23	WE-60	119
85623	161	96829	140	MF-45	75	SP50246	155	SV-DRMPFG	23	WE-65	119
85701	145	96838	140	MH-20	160	SR-30	66	SV-DS13	29	WE-70H	133
85703	145	96849	140	MH-30	160	STR-465	97	SV-DS23	28	WH-30	73
85704	145	96858	140	NT-70H	133	STR-AS19	52	SV-DS33	28	WH-70H	133
85712	145	96880	141	PM-5H	89	STR-AS19D	52	SV-DS43	28	WP-1010	127
85713	145	98000	165	RB-31	163	STR-BL24	130	SV-DSS3	27	WP-1020	127
85714	145	98000PP	165	RB-53	163	STR-BR16	64	SV-DS73	133	WP-1030	127
85718	96	98001	165	RF-30	77	STR-CC20	159	SV-DS83	29	WP-2110	129
85720	95	98001PP	165	RN-1B1	162	STR-CC20A	159	SV-DS93	29	WP-2120	131
85720IB	95	98002	165	RN-1B2	162	STR-CE24	97	SV-DSMP	28	WP-2130	131
85720PP	95	98003	165	RN-1B3	162	STR-CE36	97	SV-DT35	22	WP-2135	129
85721	96	98039	165	RN-1H1	162	STR-CE48	97	SV-GD10	39	WP-2136	130
85724	95	AF-20	76	RN-1H2	162	STR-CE612	97	SV-GD24	39	WP-2137	130
85725	96	AF-20D	76	RN-1H3	162	STR-CE816	97	SV-GD34	39	WP-2140	131
85728	95	AR-30	66, 156	RN-1H4	162	STR-CF5	75	SV-GD34CB	39	WP-2145	129
85730	94	AU-02T	59	RN-1PBH1	162	STR-CL24	129	SV-GD44	39	WP-3210	128
85731	94	AU-A1	59	RN-1PBH2	162	STR-EA36	129	SV-GD50	39	WP-3220	128
85732	94	AU-A2	59	RN-1PBH3	162	STR-EXB36	130	SV-GL24	39	WP-3230	128
85733	94	AU-S2	59	RN-541	163	STR-GP14	49	SV-IR50	46	WP-5400	134
85736	94	AU-S3	59	RN-542	163	STR-GP14D	49	SV-LD20	35	WP-5401	134
85738	94	AU-S4	59	RN-641	163	STR-GS18	54	SV-LD30	34	WP-5402	134
85740	95	AU-S6	59	RN-642	163	STR-GS18D	54	SV-LD40	34	WP-5403	134
85750	119	AU-S8	59	RN-741	163	STR-H800	72	SV-LR10	24	WP-6525	132
85755	119	AU-S10	59	RN-742	163	STR-LH16	66	SV-LR20	23	WP-6535	132
85765	95	BF-20P	77	RN-B1	163	STR-LR24	68	SV-LR25	47	WP-6555	132
85770	95	BF-25	77	RN-B2	163	STR-LR36	68	SV-LR30	22	WP-7621	126
85772	95	BH-30	73	RN-B3	163	STR-PB24	137	SV-LR30CB	22	WP-8708	126
86036	71	BR-10	65	RN-H1	163	STR-PB24R	137	SV-LR34	22	WR-12	92
86050	71	BR-20	65	RN-H2	163	STR-PD48	56	SV-LR40	23	WR-18	92
87003	71	BR-35	64	RN-H3	163	STR-PD96	56	SV-LR50	21	WR-24	92
87028	71	BR-40	64	RN-H4	163	STR-PP100	140	SV-LR70	133	WR-30	92
87600	122	BR-80	65	RN-PBH1	163	STR-PR24	63	SV-LR80	23	WR-36	92
87605	122	BR-90	65	RN-PBH2	163	STR-PS200	140	SV-LR90	24	WW-4	91
87610	122	CM-30	159	RN-PBH3	163	STR-PSE200	140	SV-LS11	29	WW-5	91
87625	122	DG-10	57	RN-X1	163	STR-S600	20	SV-LS21	28	WW-6	91
87640	122	DG-11	56	RN-X3	163	STR-S600D	20	SV-LS31	28		
89023	42	DG-11FG	56	RP-5H	90	STR-S601	26	SV-LS31CB	28		
89024	42	DG-12	58	RP-6H	90	STR-S601D	26	SV-LS35	28		
89025	42	DG-12FG	58	RR-25	141	STR-S604	33	SV-LS41	28		
89026	42	DG-15	58	RR-25EH	141	STR-S604D	33	SV-LS51	27		
89044	40	DG-16	58	RR-HHM	163	STR-S605	38	SV-LS81	29		
89045	40	DG-18	58	RR-HLM	163	STR-S605D	38	SV-LS91	29		
89084	40	DG-19	93	RR-HM	163	STR-S700	20	SV-LT34	22		
89085	40	DG-23	93	RR-HS	163	STR-S700D	20	SV-PD50	48		
89095	40	DG-25	57	RR-SM	163	STR-S701	26	SV-RS20	47		
89123	41	DG-60	57	RR-XM	163	STR-S701D	26	SV-RS40	47		
89124	41	DG-75	57	SA10024	71	STR-S702	40	SV-RS50	47		
89125	42	DG-100	57	SB-48	93	STR-S703	40	SV-SDA10	51		
89126	42	DG-100FG	57	SB-60	93	STR-S704	32	SV-SDA10H	51		
89133	41	DG-106	57	SC-10	78	STR-S704D	32	SV-SDA10HL	51		
89134	41	DG-108	57	SC-20	78	STR-S705	38	SV-SDA10HM	51		
89135	41	DG-116	56	SC-24	79	STR-S705D	38	SV-SDA12	52		
89136	41	DG-118	56	SC-25	78	STR-S706	46	SV-SDA14	53		
89184	40	DG-126	58	SC-30	78	STR-S708	43	SV-SDA14H	52		
89185	40	DG-128	58	SC-48	79	STR-S709	43	SV-SDA14HL	53		
89194	40	DG-186	58	SC-79	79	STR-S710	20	SV-SDA14HM	53		
89195	40	DG-188	58	SC-79D	79	STR-S710D	20	SV-SDP12	54		

REPLACEMENT PARTS

SMW #	DESCRIPTION	UPC	PACK QTY
SA10047	Replacement Roller for 70924 and 70624	046385011583	1
SA10048	Replacement Roller for 70936 and 70636	046385011590	1
SA10049	Replacement Roller for 70948 and 70648	046385011606	1
SA10051	Replacement Roller for 72036 and 72236	046385011613	1
SA11001	Replacement Blade for Lonestar	031365014609	12
SA11002	Replacement Blade for Buckeye	031365014661	12
SA11003	Replacement Blade for Gibbs	031365014685	12
SA11006	Replacement Blade for Atlas	031365014616	12
SA11014	Replacement Head for 96811	-	1
SA11020	Replacement Head for 21310	031365023083	1
SA11022	Replacement Head for 21308	031365023069	1
SA11028	Replacement Blade for 21324	-	1
SA11029	Replacement Blade for 21326	-	1
SA20400	Replacement Handle for 11100 and 12100 Series	036723004384	1
SA22028	Replacement Part for Collar Lock	-	1
SA22034	Replacement Handle for 21505 and 21504	031365030005	1
SA22035	Extension Handle for Augers	031365022314	1
SA22036	Replacement Handle for Augers except 21312	031365022307	6
SA22037	Replacement Handle for 42324	031365124575	6
SA22039	Replacement Handle for 42455	031365124612	6
SA22050	Shovel Handle, 30" Hardwood, Poly D-Grip	031365124568	6
SA22051	Shovel Handle, 30" Hardwood, Steel D-Grip	031365124551	6
SA22052	Shovel Handle, 42" Blue Fiberglass	031365124513	6
SA22053	Shovel Handle, 48" Hardwood	031365124537	6
SA22054	Shovel Handle, 48" Hardwood Handle	031365124520	6
SA22076	Replacement Handle for Augers except 21312	for AU-512	1
SA30009	Replacement Gusset Brace - Set of 2	046385011620	1
SA30012	Replacement Oversized Gusset Braces - Set of 2	046385011637	1
SA30018	Splice for 87028 and 86036	046385011644	1
SA30035	Hardware Bag for Fixed Frame Products	046385011651	1
SA32000	Replacement ProGrip™ and End Cap	036723001000	12
SA32002	STÄ-LOK® Repair Kit	036723122415	1
SA32004	Carriage for 85721	031365129211	1
SA32005	Carriage for 85724	031365129327	1
SA32006	Carriage for 85765	031365129259	1
SA32007	Carriage for 85740	031365129235	1
SA32008	Carriage for 85725	031365129242	1
SA32009	Carriage for 85769	031365129228	1
SA60021	Lute Bolt Bag for Wrap-Around Bracing	046385011675	1
SA60058	Concrete Place Hook	046385011682	1
SP10013	24" Light Lute Head	046385011699	1
SP10014	30" Light Lute Head	046385011705	1
SP10015	36" Light Lute Head	046385011712	1
SP10016	24" Straight Light Lute Head	046385011729	1
SP10017	30" Straight Light Lute Head	046385011736	1
SP10018	36" Straight Light Lute Head	046385011743	1
SP10060	42" Light Lute Head	046385011750	1
SP10061	24" Lute Head	046385011767	1
SP10062	30" Lute Head	046385011774	1
SP10063	36" Lute Head	046385011781	1
SP10064	42" Lute Head	046385011798	1
SP10070	42" Straight Light Lute Head	046385011804	1
SP10120	24" Straight Lute Head	046385011811	1
SP10121	30" Straight Lute Head	046385011828	1
SP10122	36" Straight Lute Head	046385011835	1
SP10123	42" Straight Lute Head	046385011842	1
SP10129	Replacement Blade for 40100, 42100, and 42141	046385011859	1
SP13300	Replacement Blade for 41440 - Set of 10	046385011866	1
SP13301	Replacement Blade for 41430	046385011873	1
SP13302	Replacement Blade for 41432	046385011880	1

SMW #	DESCRIPTION	UPC	PACK QTY
SP13303	Replacement Blade for 41434	046385011897	1
SP13305	Replacement Blade for PVC Saw	046385011910	1
SP13310	Replacement Spring for 41036	046385011927	1
SP13311	Replacement Spring for 41707	046385011934	1
SP13312	Replacement Blade for 41407	046385011941	1
SP13313	Replacement Spring for 41419	-	1
SP13441	Replacement Saw Blade - Pole Pruner	-	1
SP13470	Replacement Head for 73320	046385011958	1
SP13580	Replacement Head for McLeod Rake	046385011965	1
SP13729	24" x 26" Poly Leaf Rake Head	046385090403	30
SP16003	Shingle Remover Blade Kit	036723800016	6
SP16005	Replacement Blade for Perfection	031365014647	12
SP16008	24" Replacement Snow Pusher Head	-	1
SP16012	Replacement Blade for 41463	031365015347	1
SP16013	Replacement Anvil for 41463	036723010224	1
SP16027	Replacement Blade for 41498	031365053387	1
SP16047	Replacement Blade for 21" Bow Saw	031365053400	1
SP16097	Replacement Blade for 41398	036723369131	12
SP20022	Tapered Tip Adapter	036723150098	6
SP20163	Replacement Handle for ProFlex™ Heads	046385011972	1
SP21005	Replacement Handle for 21266	031365013077	12
SP21006	Replacement Handle for 21268	031365013091	12
SP21007	Replacement Handle for 21264	031365013046	12
SP21008	Replacement Lever Handle for 21264	031365013053	12
SP21095	Replacement Handle for 21105, 21200, and 21244	031365010014	12
SP21096	Replacement Handle for 21100	031365010021	12
SP21097	Replacement Handle for 21211, 21245, and 21117	031365013121	12
SP21098	Replacement Handle for 21110	031365013114	12
SP21104	Replacement Handle for 87640	031365050911	6
SP50027	Replacement Steel Scraper Blade 8"	046385090663	1
SP50028	Replacement Steel Scraper Blade 12"	046385010357	1
SP50029	Replacement Steel Scraper Blade 16"	046385010364	1
SP50034	24" x 3" Square Edge Black Rubber Squeegee Blade	046385011989	1
SP50035	36" x 3" Square Edge Black Rubber Squeegee Blade	046385011996	1
SP50036	48" x 3" Square Edge Black Rubber Squeegee Blade	046385012009	1
SP50037	60" x 3" Square Edge Black Rubber Squeegee Blade	046385012016	1
SP50038	72" x 3" Square Edge Black Rubber Squeegee Blade	046385012023	1
SP50039	Replacement Bristles for 36" Seal Brush	046385012030	1
SP50054	24" x 3" Round Edge Tapered Black Rubber Squeegee Blade	046385012054	1
SP50055	36" x 3" Round Edge Tapered Black Rubber Squeegee Blade	046385012061	1
SP50056	48" x 3" Round Edge Tapered Black Rubber Squeegee Blade	046385012078	1
SP50057	60" x 3" Round Edge Tapered Black Rubber Squeegee Blade	046385012085	1
SP50058	72" x 3" Round Edge Tapered Black Rubber Squeegee Blade	046385012092	1
SP50065	Replacement Rope for 86036	046385012108	1
SP50067	Replacement for 84" Drag Broom	046385012115	1
SP50068	Replacement Bristles for 28" Scarifier Broom	046385012122	1
SP50071	24" x 3" Round Edge Non-Tapered Black Rubber Squeegee Blade	046385012436	1
SP50072	36" x 3" Round Edge Non-Tapered Black Rubber Squeegee Blade	046385012139	1
SP50073	48" x 3" Round Edge Non-Tapered Black Rubber Squeegee Blade	046385012146	1
SP50074	60" x 3" Round Edge Non-Tapered Black Rubber Squeegee Blade	046385012153	1
SP50076	36" Straight Blade Squeegee Replacement Blade	046385012160	1
SP50080	Replacement Grips for Wheelbarrows	046385012184	1
SP50323	Replacement Rope for Pole Pruner	046385012634	1
SP50360	Replacement Counter for 85713 / 85714	046385012283	1
SP50400	Replacement Handle for 85721	031365129266	1
SP50401	Replacement Handle for 85769, 85740, 85725	031365129273	1
SP50402	Replacement Handle for 85724	031365129334	1
SP50403	Replacement Handle for 85765	031365129280	1
SP51049	Extra Large D-grip Handle Held with Steel Rivet.	-	1

For a complete listing of ALL of our replacement parts, visit <https://seymourmidwest.com/replacement-parts-3>

PARTNERSHIP



P.O. BOX 1674, WARSAW, IN 46581-1674

P 844-SEYMOUR (739-6687) • 574-267-7875 • F 574-267-8508

CUSTOMER.SERVICE@SEYMOURMIDWEST.COM • SEYMOURMIDWEST.COM

SPECIFICATIONS SUBJECT TO CHANGE WITHOUT NOTICE.



FAMILY OWNED AMERICAN TOOL COMPANY SINCE 1872